

APPENDIX **A**

ORIGIN-DESTINATION SURVEY

This appendix contains the documentation of the origin-destination survey summary as provided by the subconsultant, IBI Group for the Transport Canada 2008 comprehensive study.

THIS PAGE INTENTIONALLY LEFT BLANK



Transport
Canada

Transports
Canada

Transport Canada

TRAFFIC AND REVENUE FORECASTER: WINDSOR
GATEWAY PROJECT
ORIGIN-DESTINATION TRAVEL SURVEYS SUMMARY
REPORT

DRAFT

DRAFT REPORT

AUGUST 2008



THIS PAGE INTENTIONALLY LEFT BLANK

TABLE OF CONTENTS

- 1. INTRODUCTION 1**
- 2. PASSENGER CAR SURVEY DESIGN AND CONDUCT 2**
 - 2.1 Survey Design 2
 - 2.1.1 Roadside Survey 2
 - 2.1.2 Mail-Back Survey..... 3
 - 2.1.3 US-Bound Travel 3
 - 2.2 Survey Formats 3
 - 2.2.1 Roadside Formats 3
 - 2.2.2 Mail-Back Formats..... 3
 - 2.3 Initial Survey Field Quotas 6
 - 2.4 Survey Conduct..... 6
 - 2.4.1 Dates and Times..... 6
 - 2.4.2 Roadside Survey 7
 - 2.4.3 Mail-Back Survey..... 12
- 3. PASSENGER CAR SURVEY DATA PROCESSING 13**
 - 3.1 Mail-Back Return Rates and Processing..... 13
 - 3.2 Data Processing 14
 - 3.2.1 Survey Organization and Identification 14
 - 3.2.2 Data Entry..... 14
 - 3.3 Quality Control 15
 - 3.4 Geocoding..... 16
 - 3.4.1 Detailed Coding Area 16
 - 3.4.2 Data Entry Location-Matching Process 16
 - 3.4.3 GIS-Based Geocoding Process 17
 - 3.5 Cleaning 18
 - 3.5.1 Process 18
 - 3.5.2 Correcting for Bias Due to Cleaning 19
 - 3.6 Additional Trip Records..... 20

TABLE OF CONTENTS (CONT'D)

3.6.1 Stated Preference Data	20
3.6.2 US-Bound Trip Information.....	20
3.7 Expansion	21
3.8 Impact of Ambassador Gateway Project.....	22
3.9 Summary	26
4. PASSENGER CAR SURVEY SUMMARY RESULTS	27
4.1 Trip Origin-Destination Patterns	27
4.2 Trip Purposes	35
4.3 Other Travel Characteristics	39
4.4 2000 to 2008 Trends	41
5. COMMERCIAL VEHICLE TRAVEL	45
5.1 Data Sources	45
5.2 Data Processing & Expansion.....	46
5.3 Impact of Ambassador Gateway Project.....	47
5.4 Summary Results	50
5.4.1 Trip Origin-Destination Patterns.....	50
5.4.2 Commodity Types	57
5.4.3 Vehicle Configurations	59
5.5 2000 to 2008 Trends	59
6. SUMMARY	63

APPENDICES

APPENDIX A: Occupational Health and Safety and Traffic Control Plan

APPENDIX B: Survey Staff Training Presentation

APPENDIX C: Superzone Origin-Destination Trip Matrices

TABLE OF CONTENTS (CONT'D)

LIST OF EXHIBITS

Exhibit 2-1: Study Area and Survey Locations.....	2
Exhibit 2-2: Example Roadside Survey Format	4
Exhibit 2-3: Example Mail-Back Survey Format.....	5
Exhibit 2-4: Initial Survey Field Quotas	6
Exhibit 2-5: Survey Dates and Times.....	6
Exhibit 2-6: Summary of Roadside Survey Collection Results	11
Exhibit 2-7: Summary of Mail-Back Survey Hand-Out Results.....	12
Exhibit 3-1: Mail-Back Survey Response Rates	13
Exhibit 3-2: Survey Data Entry Form	15
Exhibit 3-3: Correction Factors for Bias Due to Cleaning	20
Exhibit 3-4: Stated Preference Trip Records	20
Exhibit 3-5: US-Bound Trip Records.....	21
Exhibit 3-6: Passenger Car Survey Expansion Factors.....	22
Exhibit 3-7: Extents of Ambassador Bridge Gateway Project.....	23
Exhibit 3-8: Impact of Ambassador Gateway Project on Monthly Passenger Car Traffic Trends, 2004 to 2008	24
Exhibit 3-9: Expected 2008 Ambassador Bridge Share of Crossing Passenger Car Traffic	25
Exhibit 3-10: Correction for Ambassador Gateway Project, Passenger Cars	25
Exhibit 3-11: Passenger Car Survey Sample Summary Statistics.....	26
Exhibit 4-1: Weekday Passenger Car Trip Origins & Destinations, Spring 2008	28
Exhibit 4-2: Superzone System (Ten Zone).....	31
Exhibit 4-3: Weekday Passenger Car Trip Origin & Destination Matrices, Spring 2008	32
Exhibit 4-4: Weekday Passenger Car Trip Purposes, Spring 2008.....	35
Exhibit 4-5: Weekday Passenger Car Trips by Trip Purpose & Time Period, Spring 2008.....	36
Exhibit 4-6: Weekday Passenger Car Occupancy, Spring 2008	39
Exhibit 4-7: Weekday Passenger Car Trip Frequency, Spring 2008	39
Exhibit 4-8: Weekday Passenger Car Nexus Membership, Spring 2008	40
Exhibit 4-9: Weekday Passenger Car Payment Method, Spring 2008	40
Exhibit 4-10: Annual Passenger Car Traffic Volumes, 1972 to 2007	42
Exhibit 4-11: Weekday Passenger Car Travel Pattern Trends, Summer 2000 to Spring 2008.....	43
Exhibit 4-12: Weekday Passenger Car Trip Purpose Trends, Summer 2000 to Spring 2008.....	44
Exhibit 5-1: Commercial Vehicle Survey Expansion Factors.....	46
Exhibit 5-2: Impact of Ambassador Gateway Project on Monthly Commercial Vehicle Traffic Trends, 2004 to 2008	48
Exhibit 5-3: Expected 2008 Study Crossing Commercial Vehicle Traffic	49
Exhibit 5-4: Weekday Commercial Vehicle Trip Origins & Destinations, Fall 2008.....	51
Exhibit 5-5: Weekday Commercial Vehicle Travel Origin and Destination Matrix, Fall 2008	55
Exhibit 5-6: Distribution of Commercial Vehicle Volumes by Commodity Type, Fall 2008.....	57
Exhibit 5-7: Commercial Vehicle Volumes by Commodity Type, Fall 2008.....	58
Exhibit 5-8: Commercial Vehicle Configurations, Fall 2006.....	59
Exhibit 5-9: Annual Commercial Vehicle Traffic Volumes, 1972 to 2007	60
Exhibit 5-10: Weekday Commercial Vehicle Travel Pattern Trends, 2000 to 2008.....	61
Exhibit 5-11: Weekday Commercial Vehicle Commodity Type Trends, 2000 to 2008	62

THIS PAGE INTENTIONALLY LEFT BLANK

1. INTRODUCTION

The ***Traffic and Revenue Forecaster: Windsor Gateway Project*** is being prepared for Transport Canada to quantify the toll revenue generation potential of a new crossing between Windsor, Ontario and Detroit, Michigan. The analysis and forecasts for this study will be based on a 2008 update of the travel demand model developed previously for the 2004 Detroit River International Crossings Study. This was based on travel data collected in 2000 and comprised the three existing crossings of interest to this study, those being the Ambassador Bridge and Detroit-Windsor Tunnel in Windsor/Detroit and the Blue Water Bridge in Sarnia/Port Huron. In order to perform this update with current and reliable travel pattern information, two recent origin-destination (O-D) travel survey data sources will be used:

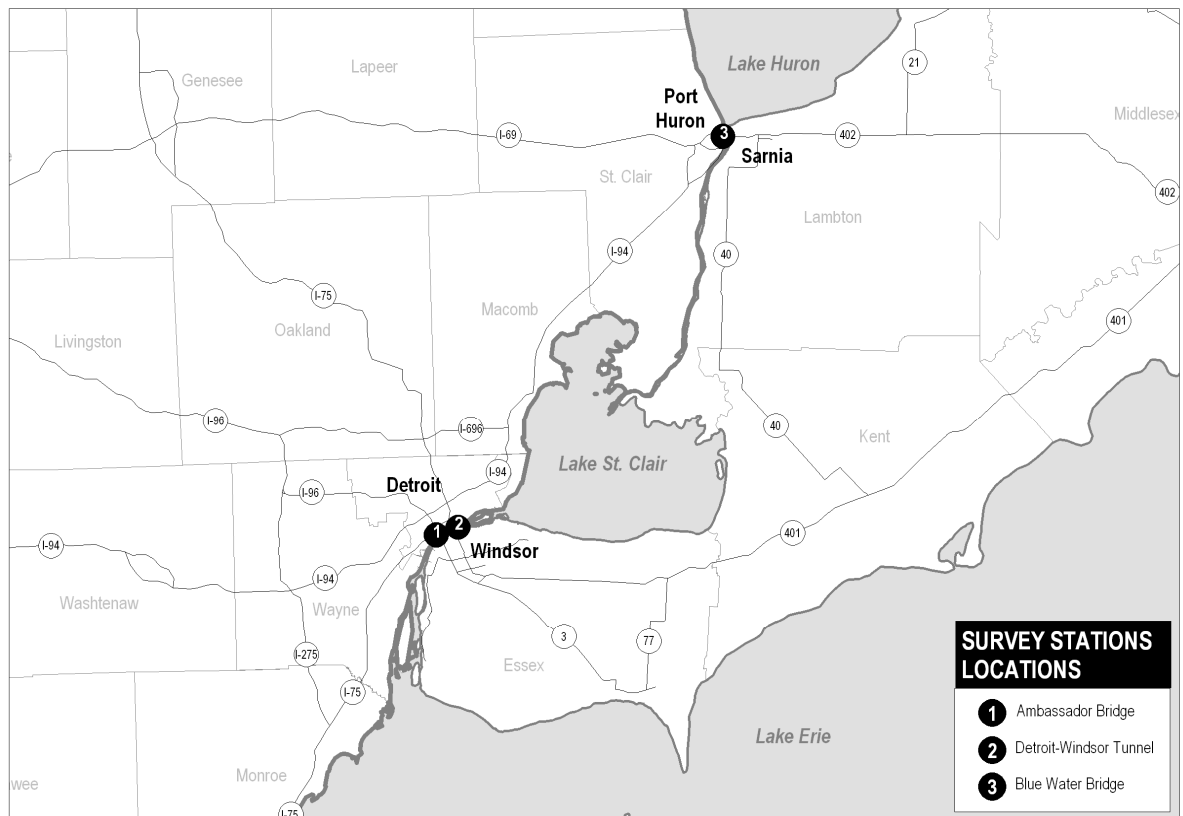
- A passenger car survey undertaken explicitly for this study in April 2008 at the three crossings, similar in nature to the 2000 Ontario-Michigan Border Crossing Traffic Study survey; and
- The 2006 National Roadside Survey (NRS) of commercial vehicles conducted by Transport Canada, which included survey stations at the Ambassador Bridge and Blue Water Bridge to intercept commercial vehicles. It is the follow-up to the 2000 NRS.

As the passenger car survey was conducted specifically for this study by the study team, the majority of this report focuses on this data source. Chapter Two describes the passenger car survey design and conduct, Chapter Three describes the processing of the data, expansion to traffic count control volumes and validation, and Chapter Four provides summary results of the passenger car survey and comparisons to the previous 2000 survey results. Chapter Five describes the expansion, validation and summary results of the commercial vehicle data. Finally, Chapter Six provides a summary of the overall results.

2. PASSENGER CAR SURVEY DESIGN AND CONDUCT

The three international crossings surveyed are shown within the context of the study area in Exhibit 2-1. To be consistent with the 2000 Ontario-Michigan Border Crossing Traffic Study survey, the passenger car survey undertaken for this study was intended to be carried out in as similar a fashion as possible. However, given various safety, operational, jurisdictional and other issues that could not be mitigated due to changes in circumstances since the 2000 survey, the final approvals received for the implementation of this survey required that a mail-back survey approach be adopted in some cases. The following describes the design and conduct of the surveys with respect to each of the roadside and mail-back methods.

Exhibit 2-1: Study Area and Survey Locations



2.1 Survey Design

2.1.1 ROADSIDE SURVEY

Approval was obtained to conduct roadside surveys at the Blue Water Bridge in both directions of travel and at the Detroit-Windsor Tunnel for travel into Canada only. This involved the intercept of motorists crossing the Detroit-Windsor Tunnel and the Blue Water Bridge during a weekday for a 24-hour period to conduct direct face-to-face interviews. Survey stations were set up with pylons, which vehicles would pass through upon clearing border inspection. Vehicles were randomly stopped and the drivers asked whether they would participate in the survey. If the driver accepted,

details about the vehicle characteristics were recorded and the driver was asked a series of questions with the responses recorded by the interviewer. The entire process took about 30 to 45 seconds.

2.1.2 MAIL-BACK SURVEY

Due to difficulties in obtaining approval for a roadside survey at the Ambassador Bridge (in either direction), a contingency plan was implemented. A mail-back survey, coordinated through the Canadian Border Services Agency (CBSA), was arranged to distribute survey packages to motorists for two consecutive weekdays for a total 48-hour period. CBSA officers handed out a survey package to drivers crossing into Canada after border inspection clearance. The package contained a questionnaire and two postage-paid envelopes for international and domestic mail-back, enabling participants to mail responses from either the US or Canada. Although roadside interviews were conducted at the tunnel, this method was also implemented at that location.

2.1.3 US-BOUND TRAVEL

As only Canada-bound travellers could be surveyed at the two Windsor-Detroit crossings, questions regarding the interviewee's trip to the US were included in these surveys. The questions were targeted towards the traveller's trip to the US that had been/would be related to the one that was surveyed. For Canadians, that is the initial trip into the US from which they would have been returning. For Americans, that is the return trip to the US that they eventually would be making.

2.2 Survey Formats

2.2.1 ROADSIDE FORMATS

A sample questionnaire used in the roadside survey for passenger cars is illustrated in Exhibit 2-2. The form was printed on standard letter-sized paper and includes the following sections: heading, vehicle identification, journey information, and information regarding the return trip to the US (i.e., for the tunnel survey only). Again, the survey format and wording was based on the 2000 Ontario-Michigan Border Crossing Traffic Study¹, however the origin and destination sections were streamlined to speed up the interview and expedite the interpretation of questions.

The questionnaire had space to record visual information about vehicle type, licence plate origin and vehicle occupancy and asked about the trip purpose, trip origin and destination, trip frequency, type of payment to pay fare, and affiliation to the Nexus program. The question about US-bound travel was asked on the Detroit-Windsor Tunnel questionnaire.

2.2.2 MAIL-BACK FORMATS

A sample questionnaire used in the mail-back survey for passenger car is illustrated in Exhibit 2-3. The form was printed on standard legal-sized paper and stated the crossing, direction of travel, and date at the moment of handing out the survey package. The heading section included a message on behalf of Transport Canada dedicated to participants of the survey, as well as instructions to complete the questionnaire and how to mail the response back. The form was based on the format used in the Ontario-Michigan Border Crossing Traffic Study for standard layout and general

¹ Prepared by Paradigm Transportation Solutions Ltd.

wording. However, the origin-destination questions were modified to expedite the survey interpretation.

The questionnaire is divided into two parts. Part one asks about the time of travel, vehicle type, origin of license plates, trip purpose, trip origin and destination, vehicle occupancy, trip frequency, affiliation to Nexus program, and type of payment used to pay fare. Part two asks about the return trip, related to the trip described in part one, including if the trip was made on the same day, which crossing was used, and the expected time of day to cross back to the US. Also, a number of survey packages were translated into French for distribution at multi-lingual border inspection booths.

Exhibit 2-2: Example Roadside Survey Format

WINDSOR GATEWAY TRAVEL PATTERN STUDY

Dear Motorist:
 Transport Canada is conducting a travel pattern survey to determine the travel characteristics of users of the Detroit River international crossings. Information given to the surveyor will be used for transportation planning and your input will provide a basis for improving the international crossing infrastructure. All information will be treated in the strictest confidence.

Date (mm-dd) Month Day	Time (hh:mm) Hour Minutes	Surveyor	Location	Direction
<input style="width: 30px; height: 20px;" type="text"/> <input style="width: 30px; height: 20px;" type="text"/>	<input style="width: 30px; height: 20px;" type="text"/> <input style="width: 30px; height: 20px;" type="text"/>		<input style="width: 30px; height: 20px;" type="text"/> 2 1. Ambassador Bridge 2. Detroit-Windsor Tunnel 3. Blue Water Bridge	<input style="width: 30px; height: 20px;" type="text"/> 1 1. Into Canada 2. Into USA

VEHICLE IDENTIFICATION

A. Vehicle type
 1. Auto / Van / Pick-up / Sport Utility Van
 2. Car and Trailer
 3. Motorcycle
 4. Taxi
 5. Motor-home / Recreational Vehicle
 6. Towing
 7. Other

B. Vehicle License
 1. Ontario
 2. Other Canada (specify) _____
 3. Michigan
 4. Other USA (specify) _____

C. Total number of occupants (including driver) _____

H. How FREQUENTLY is this trip made?
 1. Daily
 2. Weekly
 3. Monthly
 4. 4 / Year
 5. 2 / Year
 6. 1 / Year
 7. One time only
 8. Refused

I. Are you a NEXUS program member?
 1. Yes
 2. No
 8. Refused

J. Which PAYMENT method did you/will you use to pay the fare?
 1. Cash
 2. Credit card
 3. Coupon/pass
 4. Commuter card
 5. Other
 8. Refused

JOURNEY INFORMATION

D. Where did you JUST come from?
 (City) _____ (State, Prov.) _____
 (Intersection, or landmark within the Windsor-Detroit area) _____

E. What was the ACTIVITY there?
 1. Home 2. Work
 3. Shopping 4. School
 5. Casino 6. Recreation and Entertainment
 7. Other 8. Refused

F. Where are you going NOW?
 (City) _____ (State, Prov.) _____
 (Intersection, or landmark within the Windsor-Detroit area) _____

G. What will be the ACTIVITY there?
 1. Home 2. Work
 3. Shopping 4. School
 5. Casino 6. Recreation and Entertainment
 7. Other 8. Refused

ABOUT YOUR TRIP TO THE U.S.

K. Did you / will you make this trip on the same day? If no, when?
 1. Same day
 2. Other _____ (specify day)


L. Please specify the international crossing that you did / are planning to use to cross?
 1. Ambassador Bridge
 2. Detroit-Windsor Tunnel
 3. Blue Water Bridge
 4. Niagara area crossings
 5. International crossing (Sault Ste. Marie)
 6. Other

M. What hour of the day did you / will you cross to the U.S.? _____ AM PM

THANK YOU FOR YOUR PARTICIPATION IN THE SURVEY!

Source: IBI Group

Exhibit 2-3: Example Mail-Back Survey Format

 Transport Canada Transports Canada	
<p>WINDSOR GATEWAY TRAVEL PATTERN STUDY</p> <p><i>Dear Motorist:</i></p> <p>Transport Canada is conducting a travel survey to determine the travel characteristics of users of the Detroit River international crossings. You were handed this survey on TUESDAY, APRIL 15th, 2008, at the AMBASSADOR BRIDGE, coming into Canada. Please take a few minutes to complete the survey below. The information provided will be used for transportation planning purposes and your input will provide a basis for improving the international crossing infrastructure. The information you provide will be treated in the strictest confidence and will be much appreciated.</p> <p>There are two parts to the survey. The first part asks about the trip into Canada for which you were handed this survey. The second part asks about any trip that you have made or will soon make into the United States that is related to the trip described in Part 1; that is, your initial trip to the United States from which you were returning or your return trip to the United States after you travelled to Canada.</p> <p>When you have completed the survey, please place it in the appropriate postage-paid envelope provided and mail it as soon as possible. No postage is required.</p>	
<p>PART 1: YOUR TRIP INTO CANADA</p>	
1	What hour of the day did you cross into Canada? (Write down the hour and circle a.m. or p.m.) _____ a.m. / p.m.
2	What type of vehicle were you driving? (Circle one.) 1) Auto / Van / Pick-up / Sport Utility Van 2) Car and trailer 3) Motorcycle 4) Taxi 5) Motor home/ Recreational Vehicle 6) Towing 7) Other (please specify) _____
3	Where are your licence plates from? (Circle one.) 1) Ontario 2) Other Canada (specify province) _____ 3) Michigan 4) Other USA (specify state) _____
4	How many passengers were in the vehicle, including the driver? (Circle one.) 1) 1 2) 2 3) 3 4) 4 5) 5 6) 6 or more
5	Where did you BEGIN your trip on the U.S. side of your journey? (Write down the city, state, and the nearest road intersection or landmark if within the Detroit area.) _____ City/Town State Nearest road intersection or landmark (if within the Detroit area)
6	What was the purpose or activity there? (Circle one.) 1) Home 2) Work/Business 3) Shopping 4) School 5) Casino 6) Recreation/Entertainment 7) Other
7	Where did you END your trip on the Canadian side of your journey? (Write down the city, province/state, and the nearest road intersection or landmark if within the Windsor area.) _____ City/Town Province Nearest road intersection or landmark (if within the Windsor area)
8	What was the purpose or activity there? (Circle one.) 1) Home 2) Work/Business 3) Shopping 4) School 5) Casino 6) Recreation/Entertainment 7) Other
9	How frequently do you make this same trip for this same purpose? (Circle one.) 1) Daily 2) Weekly 3) Monthly 4) Four times per year 5) Twice per year 6) Once per year 7) Once only
10	Are you a NEXUS program member? (Circle one.) 1) Yes 2) No
11	Which payment method did you use to pay the fare at the crossing? (Circle one.) 1) Cash 2) Credit card 3) Coupon/pass 4) Commuter card
<p><i>Thank you for completing Part 1. In Part 2, please tell us about any trip that you have made or will soon make into the United States that is related to the trip described in Part 1; that is, your initial trip to the United States from which you were returning OR your return trip to the United States after you travelled to Canada.</i></p>	
<p>PART 2: YOUR TRIP INTO THE UNITED STATES RELATED TO THE TRIP IN PART 1</p>	
12	Did you / will you make this trip on the same day as the trip in Part 1? (Circle one.) 1) Yes 2) No If you answered "No", on what day of the week did you / will you make this trip? (Specify day) _____
13	Please specify the international crossing that you did / are planning to use to cross? (Circle one.) 1) Ambassador Bndge 2) Detroit-Windsor Tunnel 3) Blue Water Bridge 4) Niagara area crossings 5) International Bridge (Sault Ste. Marie) 6) Other (specify) _____
14	What hour of the day did / will you cross back into the United States? (Write down the hour and circle a.m. or p.m.) _____ a.m. / p.m.
<p>THANK YOU FOR YOUR PARTICIPATION IN THE SURVEY!</p> <p style="text-align: right;"></p>	

Source: IBI Group

2.3 Initial Survey Field Quotas

The initial survey field quotas shown in Exhibit 2-4 were derived from monthly statistics of passenger cars provided by the Public Bridge Operator’s Association (PBOA) for 2007. The field quotas were set to collect a minimum valid sample of 10% of average daily traffic at the three crossings for the month of April, estimated at about 4,000. To accomplish this, the field quotas assumed a certain percentage of field surveys would not be useable, requiring that about 5,750 field observations be collected.

Exhibit 2-4: Initial Survey Field Quotas

Crossing	April 2007 ADT	Initial Valid Sample	Initial Field Quota
Ambassador Bridge	15,800	1,600	2,400
Detroit-Windsor Tunnel	13,200	1,400	2,000
Blue Water Bridge	8,900	1,000	1,350
Total	37,900	4,000	5,750

As both survey methods were implemented at the Detroit-Windsor Tunnel, the field quota for the roadside method (conducted for Canada-bound traffic only) was set at half of the initial quota (based on two-way traffic volumes), or 1,000.

2.4 Survey Conduct

2.4.1 DATES AND TIMES

Exhibit 2-5 summarizes the dates and times when surveys were conducted at each crossing. Roadside surveys were conducted on weekdays during the third week of April for a 24-hour period, commencing at 12 a.m. and ending at 11:59 p.m. Given anticipated response rates and the resulting volumes of mail-back hand-outs required (see Section 2.4.3), hand-outs of these surveys required two full days. As with the roadside surveys, these were conducted from midnight to midnight.

Exhibit 2-5: Survey Dates and Times

Crossing	Method	Direction	Dates	Hours
Ambassador Bridge	Mail-back	Canada-bound	Tuesday, April 15, 2008 Wednesday, April 16, 2008	0:00 a.m. – 11:59 p.m.
Detroit-Windsor Tunnel	Mail-back	Canada-bound	Tuesday, April 15, 2008 Wednesday, April 16, 2008	0:00 a.m. – 11:59 p.m.
	Roadside	Canada-bound	Tuesday, April 15, 2008	0:00 a.m. – 11:59 p.m.
Blue Water Bridge	Roadside	Canada-bound/US-bound	Thursday, April 17, 2008	0:00 a.m. – 11:59 p.m.

2.4.2 ROADSIDE SURVEY

2.4.2.1 Staffing and Training Session

The main work force was contracted through a local human resources agent in Windsor who staffed university students from the University of Windsor from different programs and backgrounds. Other local human resources agencies were contracted to provide additional staff and cover for dropouts and absences from students.

A four-hour training session was scheduled on Monday April 14th to take place on the Holiday Inn Select located on 1855 Huron Church Rd. in Windsor at 2 p.m. Fifteen workers participated on the training session. The instruction program consisted of an in-room presentation and a practice drill, covering three topics mainly: roadside survey methodology, occupational health and safety plan/traffic control plan according the OHS regulations, and traffic control instruction. The roadside survey methodology described the survey purpose and scope, survey questions and formats, instructions of how to conduct the survey, and a survey wrapping up. Occupational health and safety plan and traffic control plan instructed important insights regarding work place safety, OHS regulations, potential hazards, field supervision and traffic control plans. An experienced traffic safety specialist from IBI Group instructed staff for the position of traffic control person and occupational health and safety plan. The training presentation is attached as Appendix B.

The training session was reinforced with a practice drill organized in the hotel parking lot, where staff had the opportunity to observe the functionality of a roadside survey station and practice their skills for interviewing. A probe car was used to simulate an interview and traffic control devices were put in place to delineate a model of a survey station. The traffic safety specialist strongly pointed-out safety risks and hazards on this stage to clarify any doubts left from the in-room presentation. At the end of the training session staff was asked to complete a quiz to evaluate their knowledge on the traffic control person duties and responsibilities. Training was finalized with a questions and answers session to solve any inquiries and concerns from staff.

All training material and instruction was developed in accordance to the OHS regulations and Ontario Traffic Manual Book 7.

2.4.2.2 Survey Crews Shifts and Roles

Staff was divided in three survey crews composed of a mix of surveyors and traffic control persons. Each survey crews was set to work twelve hour shifts to cover a 24-hour period as follows: the first crew worked from 12 a.m. to 12 p.m., a second crew replaced the first shift from 12 p.m. to 12 a.m., and an overlapped crew worked from 7 a.m. to 7 p.m. to increase the number of interviews during traffic rush hours.

Workers were provided with Personal Protection Equipment as required by the OHS, including hard-hats, vests, arm/leg reflective bands, CSA approved safety boots during survey periods. Staff assigned for traffic control was provided with 'STOP/SLOW' paddle and a flashlight with an orange cone attached for dusk/night operations.

Surveyors interviewed drivers entering the survey lane. The surveyor had to approach to the drivers window to initiate the interview with a brief introduction, followed by the survey questions and write up of responses on a blank format, and wrapping up the interview. Surveyors had to wait a signal from the traffic control person before entering the survey lane to conduct the interview. When the interview was concluded the surveyor signalled the traffic control person to let the vehicle continue the trip.

The traffic control person stopped vehicles entering the survey lane displaying a 'STOP' paddle, and hold it until the driver made a complete stop. Traffic control staff was instructed to make eye-contact with the drivers while stopping the vehicles. Once the interview was finished the traffic control person would display the 'SLOW' paddle to let the drivers continue their trip. Interviews lasted from 30 to 50 seconds in average, depending on the ability of each surveyor.

2.4.2.3 Off-Duty Police Officers

Off duty police officers were staffed through the City of Windsor and the Lambton OPP Detachment in Sarnia to assist the roadside survey operations. Off duty police officers with police cruisers were present at all times during survey periods. Their appointed duties were to direct traffic, select vehicles for the interviews, and secure the survey station area. The presence of police officers on site exerted a favourable response from drivers helping to keep the number of rejected interviews to a minimum.

2.4.2.4 Field Supervision

An IBI Group field supervisor was present on site at all times managing the station activities. Every hour the field supervisor collected surveys for a quality check. When an anomaly on the survey fill-up was detected, the supervisor would instruct the surveyors to solve any deficiencies imputable to surveying staff (i.e., illegible handwriting, incomplete heading information, wrong direction of travel, wrong time, incomplete origin/destination data, etc.).

After the quality check was finished, the supervisor conducted a survey count and stored surveys in stamped folders to keep track of the hour when surveys were collected, station, direction of travel, supervisor, and number of surveys collected. Each folder was sealed and signed by the supervisor. Also the supervisor kept a record sheet with the number of surveys collected every hour and calculated the accumulated total of surveys to compare against the sample target.

Supervisors were also in charge to install and remove the traffic devices according to the traffic control plan specifications. Inquiries and concerns from drivers and public in general related to the survey activities were directed to the IBI Group supervisor who addressed them personally.

Field supervisors also ensured that survey stations were equipped with a sufficient stock of survey formats, clipboards, pencils, labelled folders, cardboard boxes for storage, ice boxes with refreshments, batteries, fire extinguisher, two first aid kits, cell phones for supervisors, several copies of the occupational health and safety plan and traffic control plan, and a copy of the OHSA.

2.4.2.5 Detroit-Windsor Tunnel Survey Operations

The initial roadside survey traffic control plans were proposed to be similar to the 2000 Ontario-Michigan Border Crossing Traffic Study. The survey work conducted for this study was carried out successfully and the plans were therefore employed as a starting point for this study. However, some plans had to be revised to meet new requirements and configurations arising since 2000. Final plans, illustrated in Exhibit __, were adapted from the initial plans after discussion with the authorities from the City of Windsor, Detroit-Windsor Tunnel LLC, Windsor Tunnel Commission, Transit Windsor, Blue Water Bridge Canada, Ontario Provincial Police, and Transport Canada. Further details of the plans are shown in the survey Occupational Health and Safety and Traffic Control Plan, presented as Appendix A.

Traffic control devices setup on the Detroit-Windsor Tunnel started on Monday 14th at 11:30 p.m. and concluded on Tuesday 15th at 12:00 a.m. for Canada-bound traffic. A police officer blocked the border inspection plaza exit lanes while the traffic devices were being installed to detour incoming traffic off the work area. Survey operations began shortly after the supervisor verified the placement and condition of traffic control devices. This activity did not cause congestion problems due to the very low traffic volumes at this hour.



The station started using two survey lanes out of a four-lane section, from 12 a.m. to 6 a.m. Two lanes were left open to facilitate the exit of heavy trucks and Transit Windsor buses to Park Street. Approximately at 6 a.m., heavy trucks crossing into Canada and leaving through the exit on Park St., were detoured to the exit on Goyeau St., allowing the supervisor to open a third survey lane from 7 a.m. to 7 p.m. Transit Windsor buses could still use the last lane to drop-off passengers. Finally, at 7 p.m. heavy trucks were sent back to the exit on Park St., thus the third survey lane had to be removed for the rest of the survey period. Each survey lane was controlled by a traffic control person, standing at the downstream end of the lane, and two to three surveyors distributed along the lane length within the coned area.



Vehicles leaving the border inspection plaza traveled at slow speed, i.e., 5 to 20 km/h, before arriving to the survey station, so the traffic control person did not have difficulties to stop drivers. Also the police cruiser parked upstream the survey station alerted drivers of the survey ahead. Overall, the border inspection clearance process provided sufficient time gaps between vehicles to maintain the survey lanes with two to three interviews being conducted at the same time, reducing impedance of traffic flow. Some drivers not selected for the survey could not avoid entering into the survey lanes and they had to wait for the interview to be finished before continuing

the trip. However, the traffic flow was resumed promptly after the survey was terminated and vehicles waiting at the back of the queue, which were not interviewed, were not stopped for a second time.

During traffic rush hours, a few vehicles started to spillback from the survey lanes, and at this point, the traffic control persons were instructed to clear the survey lanes before stopping more vehicles for the interview. Also the police officer tried to divert as many vehicles as possible to the open lane when survey lanes were saturated. These actions reduced congestion problems. No incidents were reported through the survey period.

2.4.2.6 Blue Water Bridge Survey Operations

Installation of traffic control devices on the Blue Water Bridge began on Wednesday 16th at 11:30 p.m. and concluded on Tuesday 15th at 12:10 a.m. The installation of the US-bound traffic control devices consumed additional time because it was necessary to turn around the equipment truck to get to the station location. A police officer blocked the border inspection plaza exit lanes while the

traffic devices were being installed to detour incoming traffic off the work area. This activity did not cause congestion problems due to the very low traffic volumes at this hour.

Survey operations began on Thursday, April 17th at midnight for Canada-bound traffic and at 12:20 for US-bound traffic. Both stations were confined to a single survey lane. An off duty police officer, located upstream the survey station, selected vehicles randomly and asked them to enter the survey lane for a short interview. Traffic control staff would stop drivers entering the survey lane while one or more surveyors would conduct interviews to stopped vehicles in the station.

Time gaps between vehicle platoons arriving to the Canada-bound station gave sufficient time to select one to three vehicles at a time and sent them into the survey lane. Time gaps between vehicles arriving to the US-bound station were shorter, however the police officer managed to pull over vehicles and send them safely into the survey lane. Average speeds were faster than observed in the tunnel, i.e., 20 to 40 km/h, but presence of the police cruisers warned motorists to reduce their speed again. No incidents were reported through the survey period.

Although the survey station layout configuration was not as efficient as the tunnel because of a reduced number of survey lanes that restricted the number of interviews per hour. However, it was adequate for obtaining the field quota.

2.4.2.7 Results

Exhibit 2-6 summarizes the number of surveys collected at each site and the average weekday (Tuesday to Thursday) traffic counts collected simultaneously. The number of surveys collected surpassed the initial roadside field quotas. At the Detroit-Windsor Tunnel, 1,083 surveys were collected in total for the Canada-bound direction, which represents an intercept rate of 17%. During the morning rush hour period, i.e., 6 to 9 a.m., the intercept rates surpassed 30% of total traffic. For the Blue Water Bridge 1,612 surveys were collected for both directions of travel, which represents an intercept rate of 18%. During the morning rush hour period, intercept rates were above 15%. Thus, the proportion of traffic surveyed was generally well above the 10% target, allowing for greater flexibility during the data cleaning process.

Exhibit 2-6: Summary of Roadside Survey Collection Results

Hour Beginning	Detroit-Windsor Tunnel (Canada-bound)			Blue Water Bridge (Canada-bound & US-bound)		
	Number of Surveys	Avg. Traffic Volume ¹	Intercept Rate	Number of Surveys	Avg. Traffic Volume	Intercept Rate
12 a.m.	13	110	12%	4	104	4%
1	26	57	46%	18	69	26%
2	13	29	45%	20	69	29%
3	20	21	95%	13	72	18%
4	9	16	55%	23	111	21%
5	27	45	60%	45	150	30%
6	38	90	42%	58	268	22%
7	91	153	59%	76	375	20%
8	66	174	38%	75	460	16%
9	60	203	30%	142	550	26%
10	81	180	45%	134	609	22%
11	53	237	22%	98	569	17%
12 p.m.	50	247	20%	92	583	16%
1	54	280	19%	111	590	19%
2	44	345	13%	77	616	13%
3	100	506	20%	68	623	11%
4	68	645	11%	151	645	23%
5	69	665	10%	114	602	19%
6	64	602	11%	86	571	15%
7	28	460	6%	53	450	12%
8	35	321	11%	45	380	12%
9	26	349	7%	45	323	14%
10	35	239	15%	44	217	20%
11	13	246	5%	20	151	13%
Total Surveys	1,083	6,221	17%	1,612	9,157	18%

¹ Count for Detroit-Windsor Tunnel is for Canada-bound traffic only.

2.4.3 MAIL-BACK SURVEY

Survey packages were distributed on the Ambassador Bridge and the Detroit-Windsor Tunnel to motorists crossing into Canada for a two-day period. After clearing the driver through border inspection, CBSA border services officers handed them a survey package. The border inspection booths were supplied with a stock of survey packages throughout the survey period, and an IBI Group supervisor made sure the booths did not run out of stock. Preparation of the survey packages involved the following tasks:

- Design of artwork for the postage-paid envelopes, i.e., international and domestic, which had to be approved by Canada Post;
- Printing survey forms, international/domestic pre-paid postage return envelopes and package envelopes;
- Folding and inserting the survey form, pre-paid envelopes, and stated preference survey cards into the package envelopes;
- Sealing the package envelope; and
- Shipping the survey packages to the survey sites.

For the mail-back survey, a 15% response rate was assumed according to past experience in similar studies. Based on the initial field quotas, 16,000 and 13,500 survey packages were prepared for the Ambassador Bridge and Detroit-Windsor Tunnel, respectively. As shown in Exhibit 2-7, not all of these packages were handed out over the two-day period. While the actual observed volumes obtained from traffic counts collected simultaneously with the hand-out show that these package volumes were somewhat higher than required, only about 60% of the volume possible was handed out.

Exhibit 2-7: Summary of Mail-Back Survey Hand-Out Results

Facility	Initial Field Quota	Packages Prepared ¹	Observed Two-Day, Canada-bound Volume	Approx. Packages Distributed	% of Possible Distribution
Ambassador Bridge	2,400	16,000	12,700	6,900	54%
Detroit-Windsor Tunnel	2,000	13,500	12,400	8,500	69%
Total	5,400	29,500	25,100	15,400	61%

¹ Assuming 15% response rate.

3. PASSENGER CAR SURVEY DATA PROCESSING

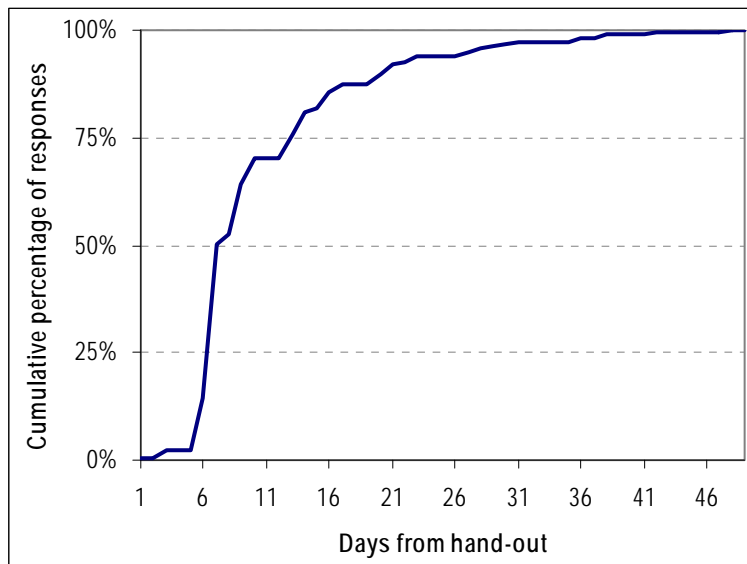
3.1 Mail-Back Return Rates and Processing

Passenger vehicle survey responses were mailed by respondents using postage-paid Business Reply Mail envelopes addressed to the “Windsor Gateway Study”. These responses were delivered directly to the IBI Group office, where each return was opened and stamped with the date received and with a unique identification number for internal processing and quality control.

As shown in Exhibit 3-1, a total of 2,294 mail-back surveys were processed that represent an average response rate of 15% at both crossings, as anticipated. Individual response rates were 17% for the Ambassador Bridge and 15% for the Detroit-Windsor Tunnel. Exhibit 3-1 also illustrates the cumulative response rate by number of days that began within two days following the hand-out.

Exhibit 3-1: Mail-Back Survey Response Rates

A. Cumulative Responses by Time



B. Response Rates

Facility	Approx. Packages Distributed	Responses Received	Response Rate ¹	Observed Two-Day, Canada-bound Volume	Proportion of Traffic Volume
Ambassador Bridge	6,900	1,150	17%	12,700	9.1%
Detroit-Windsor Tunnel	8,500	1,234	15%	12,400	10.0%
Total	15,400	2,384	15%	25,100	9.5%

¹ Proportion of packages distributed.

When mail return volumes were high, Canada Post would hold up responses for up to a few days before delivery of bins of responses to IBI Group, resulting in some staggering in the plot rather than smooth lines. The response rate does not seem to affect the quality of responses: usable responses are mailed in at the same rate as unusable responses. A comparison of the return rate of responses that were later validated to be complete and usable trip records to responses that were not usable due to incomplete, irrelevant or unusable data did not show any noticeable differences. A cut-off date of June 3rd, 2008 was set for processing of mail-back survey forms.

3.2 Data Processing

3.2.1 SURVEY ORGANIZATION AND IDENTIFICATION

After the roadside survey activities were concluded, the boxes containing the completed questionnaires were taken back to the IBI Group office. Completed questionnaires were extracted from envelopes and organized according to the international crossing, direction of travel and time of interview. Then each survey was stamped with a unique incremental folio number for quality control purposes. Roadside survey questionnaires were stamped with folio numbers starting from 0 for the Blue Water Bridge and from 2,000 for the Detroit-Windsor Tunnel.

Mail-back responses were mailed to the IBI Group office where data entry staff would open the envelopes to extract the survey questionnaires and organize them by international crossing. The mail-back questionnaires were stamped with the received date and folio numbers starting from 10,000 for the Ambassador Bridge and 20,000 for the Detroit-Windsor Tunnel.

3.2.2 DATA ENTRY

Data entry staff coded the survey questionnaires (i.e., roadside and mail-back) into an electronic survey database. IBI Group professional staff trained the data entry staff in the use of the data entry software and general procedures, providing direct follow-up and monitoring performance.

The survey response database was developed in Microsoft Access to create an electronic file of survey responses. The survey response database contains a data entry form that feeds data to a trip record stored in a table. The data entry form used for coding is illustrated in Exhibit 3-2. As can be observed, the data entry form is similar to the survey questionnaire layout, facilitating the data entry task.

Data entry staff coded responses verbatim in the white boxes on the form, while the shaded boxes were used for interpretation and formatting of location information. Uncertainties that arose during the coding process were recorded in the notes box, which would allow subsequent review and verification by professional staff.

The data entry form was implemented with look-up menus to reduce coding errors. Multiple-choice questions like survey station, direction of travel, vehicle type, license plate, trip purpose at origin and destination, frequency, vehicle occupancy, type of payment and nexus program member, were required to match a list of valid responses. In cases where respondents selected more than one answer, for the trip purpose in origin or destination, a single choice was generally assigned according to the following hierarchy of trip purposes: recreation/entertainment, work, school, shopping, casino, and other.

Location information was required to match a list of valid responses using drop-down menus, where data entry staff could search for available options and select the most appropriate choice. Location

information could be formatted using one of four possible options: street number and street, major intersection, landmark, and city/town.

Exhibit 3-2: Survey Data Entry Form

Source: IBI Group

3.3 Quality Control

IBI Group implemented an extensive quality control process to minimize the data entry errors. The quality control process includes the following items:

- **Look-up lists** – These lists validated the data coding process and included valid locations for origin-destination information and valid responses to multiple-choice responses. Data entry staff had to use the look-up lists in order to input data into the database;
- **Coder comments** – Data entry staff provided comments in cases where a proper location match could not be assigned to an origin or destination location. These cases

include limited information provided on the questionnaire, illegibility of handwriting, invalid intersection (e.g., one defined by two parallel roads), or any other reason. These comments assisted professional staff in a later review of trip records. Professional staff had the task to review and change trip records, if necessary, in cases that presented difficulties to code or if a logical answer could be inferred from the information on the form;

- **Numbering of survey questionnaires** – A unique folio number was stamped in each survey to allow an efficient identification of trip records. The folio number was an important item to input on the data entry process. This allowed checks between the database trip records and hard copies of survey questionnaires;
- **Random checks and survey inspection** – Professional staff also conducted random checks on the work performed by data entry staff, by comparing trip records from the database against the hard copy. Also professional staff verified surveys that appeared to represent invalid trips; and
- **Multiple responses** – In cases where more than one answer was given for multiple-choice responses, professional staff reviewed the questionnaire to try to deduct an appropriate and consistent response, using other information provided by respondents.

3.4 Geocoding

3.4.1 DETAILED CODING AREA

Geocoding consists of assigning 'x' and 'y' map coordinates to the reported trip origin and destination locations. This task was conducted at two levels of detail:

- **Within detailed geocoding area** – Reported origin and destination locations inside this area, consisting of the Municipality of Windsor and Wayne County, were coded to either the nearest road intersection or landmark; and
- **Outside of detailed geocoding area** – Reported locations were coded to the nearest town/city within Ontario and Michigan or to the province/state outside of Ontario and Michigan.

3.4.2 DATA ENTRY LOCATION-MATCHING PROCESS

As explained before, data entry staff formatted the reported origin and destination location information using the look-up menus in the data entry form. The look-up lists were created using the following available data:

- **Streets** – Staff created a list with a total of 39,289 streets for address matching within the geocoding area (i.e., 36,651 streets in Detroit, Michigan, and 2,638 streets in Essex County, Ontario). The list was built up from StreetPro Ontario files and TransCAD street files which were converted to MapInfo format. Street files were updated by professional staff to reflect recent road network developments, and to fill in gaps in street information in rural areas. The look-up lists were integrated with the municipality and province/state information so data entry staff could ensure a correct match.

- **Landmarks** – A list with 73 landmarks was created within in the detailed geocoding area (i.e., 45 landmarks in Detroit, Michigan and 28 landmarks in Windsor, Ontario). Professional staff generated geocoded the list of landmarks to cover frequent survey responses that were identified by data entry staff. These responses included casinos, golf courses, shopping areas, parks and campgrounds, popular services, major employers, schools, hospitals, libraries, and popular restaurants.
- **States/Provinces and Towns** – A list with 4,228 towns, provinces and states was created for Canada and US Town records for Ontario were integrated with the municipality and regional municipality, while town records for Michigan were integrated with the municipality and state to ensure an accurate match.

For origin and destination locations inside the detailed geocoding area, priority was given to match trip ends to street addresses, intersections or landmarks when detailed information was reported. For locations outside of the detailed geocoding area with a reported address, intersection or landmark, trip ends were matched to the level of the nearest city/town/settlement.

Successful address matching required a general knowledge of the study area and of the different names that an individual roadway can take. Multiple names are common in rural areas. In some cases, multiple street names were included in the lists; for example, County Road 46 is also known as North Talbot Road in the Town of Tecumseh, and Middle Road in the Town of Lakeshore. Also, the fact that many road names in the area involve numbers can be cause for confusion (e.g., there is a 3rd Concession Road in Lakeshore, and a Third Concession Road in Essex, and Highway 3, all of which represent different roads). Survey respondents commonly omitted the street direction (e.g., Riverside Drive West or East). Many times the correct direction could be determined by other information on the survey form, or later in the geocoding process by the absence of the street number in the incorrect direction.

One issue in coding of some intersections was the existence of two intersections of the same two streets. For instance, Grand Boulevard and Jefferson in Detroit intersect at two different locations within the study area, one being at Jefferson West and the other one at Jefferson East. The correct location could at times be inferred from the travel direction, the location relative to the survey station, or other information provided by the respondent.

Accurate matching of towns required detailed examination of reported origin, destination and station and direction of travel. Existence of common names for different towns or townships required further analysis of the reported trip by data entry staff or the IBI Group supervisor. An example is Grosse Pointe, Grosse Pointe Farms, Grosse Pointe Park, and Grosse Pointe Woods in Michigan.

In cases where the respondents provided a place name (e.g., work place, restaurant, store), an effort was made to find a location to match one of the above lists by looking up these locations using Google Maps or other Internet resources. Rural addresses reported using a lot and concession number were determined from a road atlas that indicates rural lots, and coded to the nearest town, intersection, etc., as appropriate. The road atlas also provided towns/settlements that were not always included in Internet mapping applications. Data entry staff had direct access to these resources and if they could not identify a valid location match, professional staff reviewed the form at later stage.

3.4.3 GIS-BASED GEOCODING PROCESS

Towns and landmarks 'x' and 'y' coordinates were obtained in the early stages of the data entry process, providing a quick method to geocode these points. However, the geocoding of street

addresses and intersections within the detailed geocoding area required further processing in MapInfo. This process required data cleaning and interpretation by professional staff.

The geocoding process for street addresses and intersections had two sources of data. StreetPro street files provided street data for the Windsor area in MapInfo format and TransCAD street files provided street data for the Detroit area. The TransCAD files were converted into the MapInfo format for consistency when evaluating the full data sample.

MapInfo automatically geocoded addresses provided as either a street number and name or as an intersection of two streets. However, professional judgment was used during the geocoding process if the street number was not provided or did not fall in the expected address range. For shorter streets, when no street number was provided for a reported address or where the street and address files did not contain address range information, the trip end was coded to the approximate centre of the street. Where the street files did not provide address ranges for streets, the approximate position on the street could at times be determined using web-based mapping utilities that do have this information.

In the end, 21% of trip ends were geocoded to a reported landmark, 2% of trips ends were geocoded using street address information, 63% were geocoded to the nearest intersection, and the remaining 14% were geocoded to the nearest town or state/province.

3.5 Cleaning

3.5.1 PROCESS

Both prior to and after the geocoding process described above, several checks were made to verify that each trip record was useable and logical, and to identify any records that needed to be rejected from the sample. A pre-screening of the data was performed prior to geocoding. The criteria used to determine whether a record would be kept include:

- **Valid trip time** – Trip time is required for data expansion purposes;
- **Valid trip origin and destination purpose** – Used to define the overall trip purpose, which is used to stratify the travel demand model trip matrices; and
- **Valid information for geocoding process** – Required to assign geographical x,y coordinates, which are then used to assign traffic zones to trip origins and destinations.

These trip characteristics were considered crucial to the usability of the trip record for developing trip matrices for the travel demand model. Trip records that had invalid entries for other, non-crucial variables (e.g., vehicle occupancy) were retained. Trip records that did not meet all of these criteria were rejected from the sample and did not undergo the geocoding process.

Records that met the above criteria and were geocoded were then checked manually to ensure that the trip trajectory was logical given the origin, destination and crossing used. Illogically reported trajectories could potentially be due to, among other reasons:

- **Reporting on the reverse trip back rather than the one observed** – When the direction of travel was not congruent with the trip origin and destination. While the crossing direction information would in most cases be more reliable (except for cases of roadside interviewer error), the trip origin and destination information can not simply

be transposed as it is not known whether the respondent is simply confusing origin and destination or reporting on a different trip altogether (potentially with different time, purpose, etc. characteristics);

- **Reporting on trips using other crossings** – Some mail-back respondents were obviously reporting on trips through other, non-study crossings, such as the Niagara crossings;
- **Reporting on trip chains/journeys rather than single trips** – Often from travel with intermediate stops that deviate from the most direct route to the final destination. For instance, if a driver travels from Detroit to Ann Arbor but picks up a passenger in Windsor, for travel modeling purposes, this would be considered two separate trips rather than one trip; and
- **Both trip ends in the same country** – Even if the respondent is reporting on a single trip, given the physical geography of the study area, this result may or may not be logical (i.e., one can travel from the US to the US via Canada). As judgement is required, this reason in particular highlights the need for manual inspection.

Trip trajectories were plotted and manually checked, with records failing the check rejected.

In summary, about 22% of the 5,080 original trip records were rejected during the cleaning process, leaving a total of 3,972 survey records with clean, geocodable information.

3.5.2 CORRECTING FOR BIAS DUE TO CLEANING

For the most part, it can be assumed that the application of the cleaning process described above would result in a unbiased survey sample; for example, that the distribution of observations with missing trip time information is random and therefore their exclusion from the final sample does not introduce a systematic bias. However, the requirement of increasingly detailed location information for trips with a trip end in the detailed geocoding area shown previously and the exclusion of records without this information would lead to a bias towards longer-distance trips, as respondents are less likely to provide accurate, reliable information as the level of detail required increases. During the survey, respondents were asked to provide city and state/province information only if outside the detailed area and for intersection or landmark information if within.

A systematic bias was confirmed within the sample after cleaning by comparing the proportion of records with a trip end within the detailed area before cleaning to that after. To compensate, correction factors, shown in Exhibit 3-3, were developed by crossing and time period to bring the proportion of trips within the detailed geocoding area back to the pre-cleaning values. The factors are essentially trip record weightings that are applied to the expansion factors developed in Section 3.7.

Exhibit 3-3: Correction Factors for Bias Due to Cleaning

Time Period	Ambassador Bridge		Detroit-Windsor Tunnel	
	Within Windsor-Detroit	Not Within Windsor-Detroit	Within Windsor-Detroit	Not Within Windsor-Detroit
AM Peak	1.07	0.79	1.04	0.77
Mid-day	1.25	0.82	1.07	0.70
PM peak	1.10	0.89	1.04	0.77
Evening	1.10	0.88	1.03	0.84
Night	1.17	0.81	1.03	0.86

3.6 Additional Trip Records

Additional information was available to create a richer survey sample for the creation of trip matrices for the travel demand model. The sources used include the stated preference survey and the US-bound trip information from the Ambassador Bridge and Detroit-Windsor Tunnel surveys.

3.6.1 STATED PREFERENCE DATA

A stated preference survey was undertaken in conjunction with the revealed preference travel survey described in this report. In it, information about actual trips made (i.e., revealed preference data) was collected including trip time, purpose, and origin and destination. A total of 854 trip records were added to the survey database, with the details provided in Exhibit 3-4.

Exhibit 3-4: Stated Preference Trip Records

Crossing	Direction		Total
	Canada-Bound	US-Bound	
Ambassador Bridge	232	204	436
Detroit-Windsor Tunnel	229	125	354
Blue Water Bridge	37	27	64
Total	498	356	854

3.6.2 US-BOUND TRIP INFORMATION

As noted in the previous chapter, approval was only received for Canada-bound travel to be surveyed for trips crossing the Ambassador Bridge and Detroit-Windsor Tunnel and, as such, information about the related trip to the US (i.e., for Canadian residents, the trip that had been made or, for US residents, the trips that would be made) was collected at these sites. Information collected included the hour of day of the crossing and what crossing had been/would be used.

As with the stated preference data, this information was used to create additional trip records for the purpose of creating trip matrices for the travel demand model. Using the US-bound hour and

crossing information (where the US-bound crossing was one of the study crossings) and the original trip purpose, the trip origin and destination were transposed and used to create a new set of US-bound trip records. A total of 2,239 additional US-bound trip records were added to the survey database, as shown in Exhibit 3-5.

Exhibit 3-5: US-Bound Trip Records

Crossing	Records
Ambassador Bridge	884
Detroit-Windsor Tunnel	1,335
Blue Water Bridge	20
Total	2,239

3.7 Expansion

Each valid survey record in the sample needed to be expanded using a factor such that the sum of the expansion factors for all survey records in the sample represents the universe of passenger cars at the crossings. This task required traffic count data for each crossing. Vehicle volume counts were recorded using Automatic Traffic Recorders (ATR) for one week at each of the crossings spanning the survey periods. For expansion of the survey data, average weekday traffic counts were developed using data from Tuesday to Thursday. Expansion factors were developed by crossing, direction of travel, and time period. The time periods correspond to the periods used within the travel demand model rather than hourly to reduce the variance in factors.

The expansion factors corresponding to the full dataset used for creating trip matrices (including the additional stated preference and US-bound trip records) are presented in Exhibit 3-6 and do not include the data cleaning bias corrections discussed above. The factors range from 1.7 to 24.7, with a mean value of 6.2 and a median value of 5.4. The 24.7 value corresponding to the night period into Canada at the Ambassador Bridge is the only factor over 10. The data cleaning bias correction factors are applied to these factors on a record-by-record basis according to trip end locations.

Exhibit 3-6: Passenger Car Survey Expansion Factors

Crossing	Period	Into Canada			Into US		
		Count	Records	Exp. Factor	Count	Records	Exp. Factor
Ambassador Bridge	Night	866	35	24.7	656	71	9.2
	AM Peak	498	99	5.0	2,050	464	4.4
	Mid-day	1,571	306	5.1	1,986	301	6.6
	PM Peak	2,186	553	4.0	1,004	183	5.5
	Evening	1,250	132	9.5	576	69	8.3
	<i>Total¹</i>	<i>6,370</i>	<i>1,125</i>	<i>5.7</i>	<i>6,272</i>	<i>1,088</i>	<i>5.8</i>
Detroit-Windsor Tunnel	Night	524	128	4.1	762	136	5.6
	AM Peak	417	252	1.7	2,004	518	3.9
	Mid-day	1,493	456	3.3	1,881	358	5.3
	PM Peak	2,418	772	3.1	1,163	317	3.7
	Evening	1,369	227	6.0	658	131	5.0
	<i>Total¹</i>	<i>6,221</i>	<i>1,835</i>	<i>3.4</i>	<i>6,469</i>	<i>1,460</i>	<i>4.4</i>
Blue Water Bridge	Night	245	52	4.7	482	76	6.3
	AM Peak	427	66	6.5	676	120	5.6
	Mid-day	1,559	292	5.3	1,957	347	5.6
	PM Peak	1,249	176	7.1	1,192	232	5.1
	Evening	778	102	7.6	592	86	6.9
	<i>Total¹</i>	<i>4,258</i>	<i>688</i>	<i>6.2</i>	<i>4,899</i>	<i>861</i>	<i>5.7</i>

Note: Factors correspond to full dataset used for creating trip matrices (including the additional stated preference and US-bound trip records) and do not include the data cleaning bias corrections.

Note: AM Peak is 6 a.m. to 9 a.m.; Mid-day is 9 a.m. to 3 p.m.; PM Peak is 3 p.m. to 7 p.m.; Evening is 7 p.m. to 11 p.m.; Night is 11 p.m. to 6 a.m.

¹ Total factors are for display only and provide a summary of the specific individual factors.

3.8 Impact of Ambassador Gateway Project

The Ambassador Gateway Project commenced in late February 2008. As illustrated in Exhibit 3-7, it closed a section of the I-75 freeway between Rosa Parks Boulevard and Clark Street in southwest Detroit, directly north of and affecting access to the Ambassador Bridge during the travel survey conducted in April. While detours to/from the bridge were provided, the additional delay to travellers would be reflected in the travel characteristics represented in the survey data. As the construction and its potential impacts are a temporary phenomena, a correction was developed for application to the data to make them reflect pre-construction conditions. The following describes the analysis and development of the correction factors.

Exhibit 3-7: Extents of Ambassador Bridge Gateway Project



Source: MDOT

Note: Only the I-75 section was affected at the time of the travel survey.

The construction could have two potential impacts on international travel behaviour, namely trip generation (i.e., if it discourages making a trip at all) and the choice of crossing (i.e., if it diverts a trip to another crossing). Furthermore, for the latter impact, the trip could be diverted to one of the other two crossings in the study area or to other crossings outside of it.

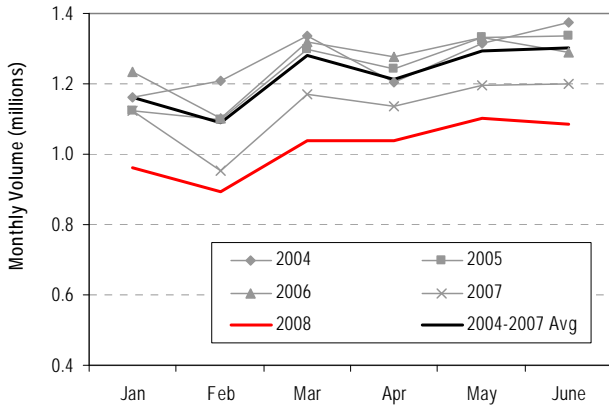
Monthly time-series crossing volume data from the PBOA were available spanning from 1999 to June, 2008 to help isolate and analyse the impact of the construction. The results of this analysis are shown in Exhibit 3-8. As the construction began in late February, monthly traffic volumes and crossing shares from January to June of 2008 were compared to the four-year average trends from 2004 to 2007. Earlier data were not included to avoid the more turbulent period that began in 2000.

In terms of trip generation/volumes, the results show that no significant amount of travel was affected by the construction. Already below the four-year trend prior to construction, the total volume at the study crossings follows the four-year trend behaviour, showing no deviation in March, when any impacts of construction would begin to be noticed. The total volume at other Ontario crossings follows the four-year trend in magnitude and behaviour. Furthermore, there was no diversion of traffic from the bridge to other crossings outside of the study area.

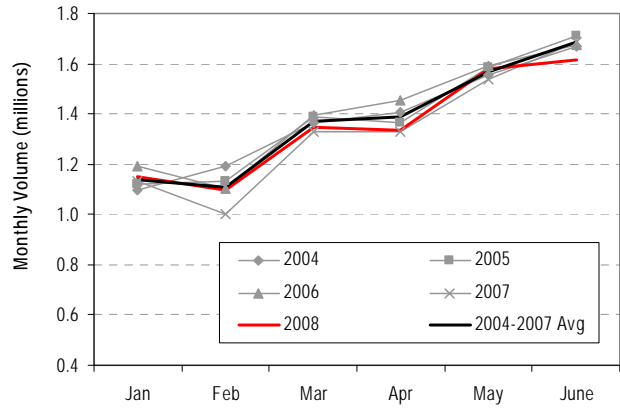
In terms of the diversion of traffic to the two other crossings within the study area, the results show that the Ambassador Bridge lost a significant share of its traffic at the beginning of construction. In April, the Ambassador Bridge share was four points below the four-year trend value of about 40% of total.

Exhibit 3-8: Impact of Ambassador Gateway Project on Monthly Passenger Car Traffic Trends, 2004 to 2008

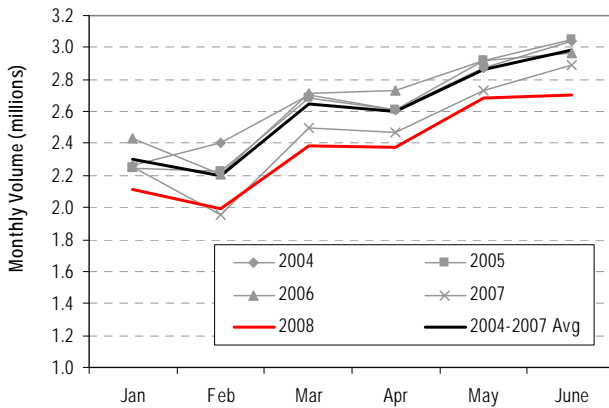
A. Total Traffic Volumes on Study Crossings



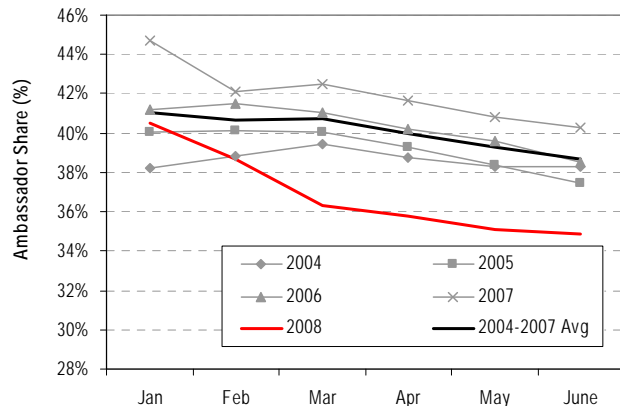
B. Total Traffic Volumes on Other Ontario Crossings



C. Total Traffic Volumes on All Ontario Crossings



D. Ambassador Bridge Share of Total Study Crossing Volumes



Source: PBOA

As trip volumes across the study crossings were not affected but the crossing shares were, the correction involves adjustment of the shares back to no-construction conditions only. To do this, the traffic counts from which the data expansion factors were developed were adjusted to reflect the expected shares shown in Exhibit 3-9. These shares reflect conditions just before the beginning of construction and are also consistent with the four-year trend for April. As the shares observed from the traffic counts (i.e., the average of Tuesday to Thursday from one week) are slightly different than the shares from the monthly PBOA data, the count shares were adjusted by pivoting off of the PBOA share differences between January and April, as shown in Exhibit 3-10. The adjusted counts were then used to develop corrected expansion factors.

Exhibit 3-9: Expected 2008 Ambassador Bridge Share of Crossing Passenger Car Traffic

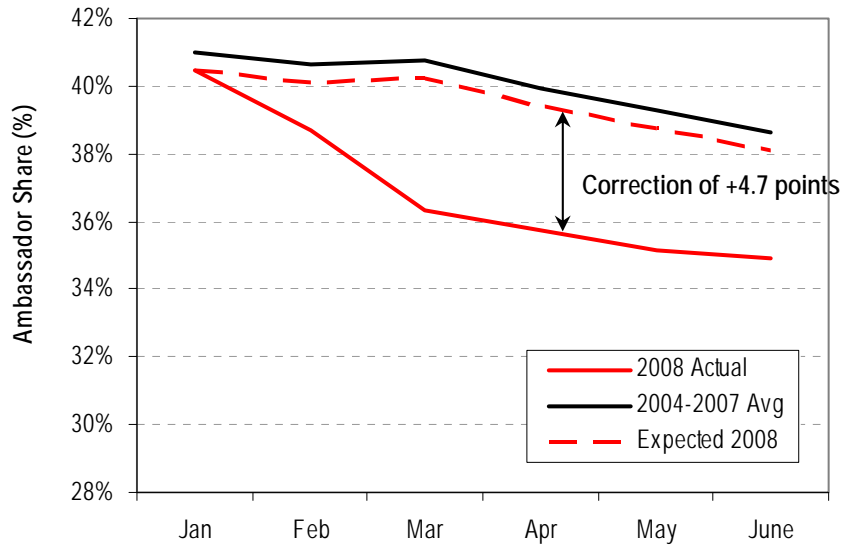


Exhibit 3-10: Correction for Ambassador Gateway Project, Passenger Cars

Crossing	Traffic Counts, April 2008		PBOA Shares, 2008			Corrected	
	Volumes	Shares	April	January	Diff	Shares	Volumes
Ambassador Bridge	12,642	36.7%	35.8%	40.5%	4.7%	41.4%	14,300
Detroit-Windsor Tunnel	12,690	36.8%	38.9%	36.3%	-2.6%	34.2%	11,800
Blue Water Bridge	9,157	26.6%	25.4%	23.2%	-2.2%	24.4%	8,400
Total	34,489	100.0%	100.0%	100.0%	0%	100%	34,500

3.9 Summary

After processing, geocoding and cleaning of the survey data, the final passenger car survey sample consists of 3,972 observations, representing 11.5% of the total average daily two-way volumes on the study crossings of about 34,500 vehicles. After adding the stated preference survey data and the US-bound trip information from the Ambassador Bridge and Detroit-Windsor Tunnel surveys, the sample size used to create trip matrices for the travel demand model is 7,065, or 20.5% of the total volume. A summary of the sample statistics is presented in Exhibit 3-11.

Exhibit 3-11: Passenger Car Survey Sample Summary Statistics

Crossing	Direction	Traffic Counts ¹	Survey Only		With Additional Data	
			No. of Obs.	% of Count	No. of Obs.	% of Count
Ambassador Bridge	Into Canada	6,370	893	14.0%	1,125	17.7%
	Into US ²	6,272	N/A	N/A	1,088	17.3%
	<i>Sub-total</i>	<i>12,642</i>	<i>893</i>	<i>7.1%</i>	<i>2,213</i>	<i>17.5%</i>
Detroit-Windsor Tunnel	Into Canada	6,221	1,606	25.8%	1,835	29.5%
	Into US ²	6,469	N/A	N/A	1,460	22.6%
	<i>Sub-total</i>	<i>12,690</i>	<i>1,606</i>	<i>12.7%</i>	<i>3,295</i>	<i>26.0%</i>
Blue Water Bridge	Into Canada	4,258	659	15.5%	696	16.3%
	Into US	4,899	814	16.6%	861	17.6%
	<i>Sub-total</i>	<i>9,157</i>	<i>1,473</i>	<i>16.1%</i>	<i>1,557</i>	<i>17.0%</i>
Total	Into Canada	16,850	3,158	18.7%	3,656	21.7%
	Into US	17,640	814	4.6%	3,409	19.3%
	<i>Sub-total</i>	<i>34,489</i>	<i>3,972</i>	<i>11.5%</i>	<i>7,065</i>	<i>20.5%</i>

¹ Represents average of traffic volumes from Tuesday to Thursday. Not adjusted for Ambassador Gateway Project.

² Survey operations not approved.

4. PASSENGER CAR SURVEY SUMMARY RESULTS

The following presents summary results using information obtained from the travel survey, expanded to the total volumes at each crossing by time period and direction of travel. The results are representative of car travel during a typical weekday in April, 2008, prior to the Ambassador Gateway Project construction currently underway.

4.1 Trip Origin-Destination Patterns

The spatial distribution of the passenger car trip origins and trip destinations is presented in Exhibit 4-1 for all three study crossings, by direction of crossing. Exhibit 4-3 shows the number of trips and proportions using the travel origin-destination superzones defined in Exhibit 4-2. More disaggregate matrices are presented as Appendix C.

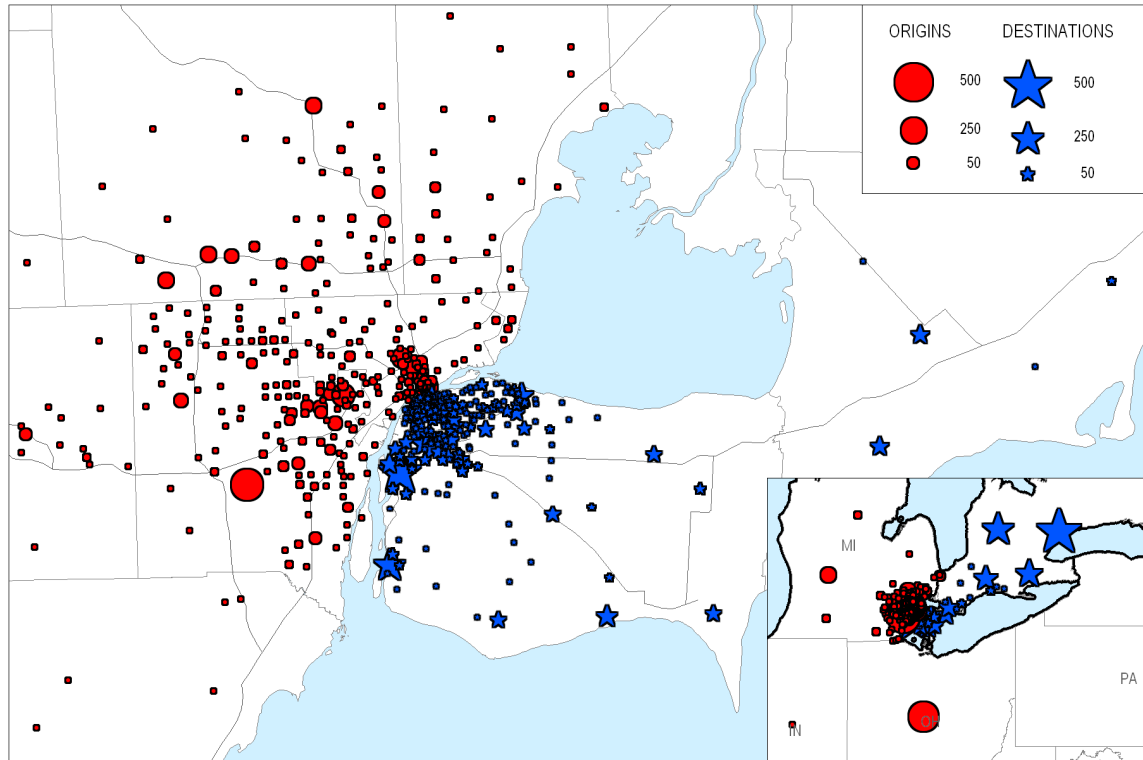
The **Ambassador Bridge**, with an average weekday volume of about 14,300 cars, serves both local and long-distance traffic. About three-quarters of travel is between Windsor-Essex and the SEMCOG area, however with only about 12% between the cities of Windsor and Detroit. The remaining quarter comes from/goes to areas much farther away. On the US side, only about 1% of travel is related to the rest of Michigan, with the majority of travel from Ohio and southern states along the coast, such as Florida. On the Canadian side, a large share of long-distance travel is related to the Greater Toronto Area and other areas in Ontario. A very small amount is attributable to the rest of the country.

The **Detroit-Windsor Tunnel** carries an average weekday volume of about 11,800 cars. Relative to the bridge, it is far more oriented to Windsor-Essex/SEMCOG traffic, which is responsible for over 90% of this volume, with almost 30% between the cities of Windsor and Detroit. This is due to the location of this facility within the two cities (i.e., directly within the downtown areas of each) and its lack of direct connections to the freeway systems on each side of the border. Given the difficulty in finding and accessing this facility, virtually no traffic is long-distance to long-distance.

The average weekday car volume on the **Blue Water Bridge** is about 8,400 vehicles. Given the sizes of the cities of Sarnia and Port Huron and the lack of the cross-border commuting phenomenon that exists in Windsor-Detroit (see below), only about 28% of traffic is local-to-local, defined as Lambton County on the Canadian side and St. Clair County on the US side. Thus, a substantial proportion of travel is long-distance. On the Canadian side, over one-quarter of traffic is going to or from other parts of Ontario, while about 13% of travel is related to other states other than Michigan.

Exhibit 4-1: Weekday Passenger Car Trip Origins & Destinations, Spring 2008

A. Ambassador Bridge, to Canada



B. Ambassador Bridge, to US

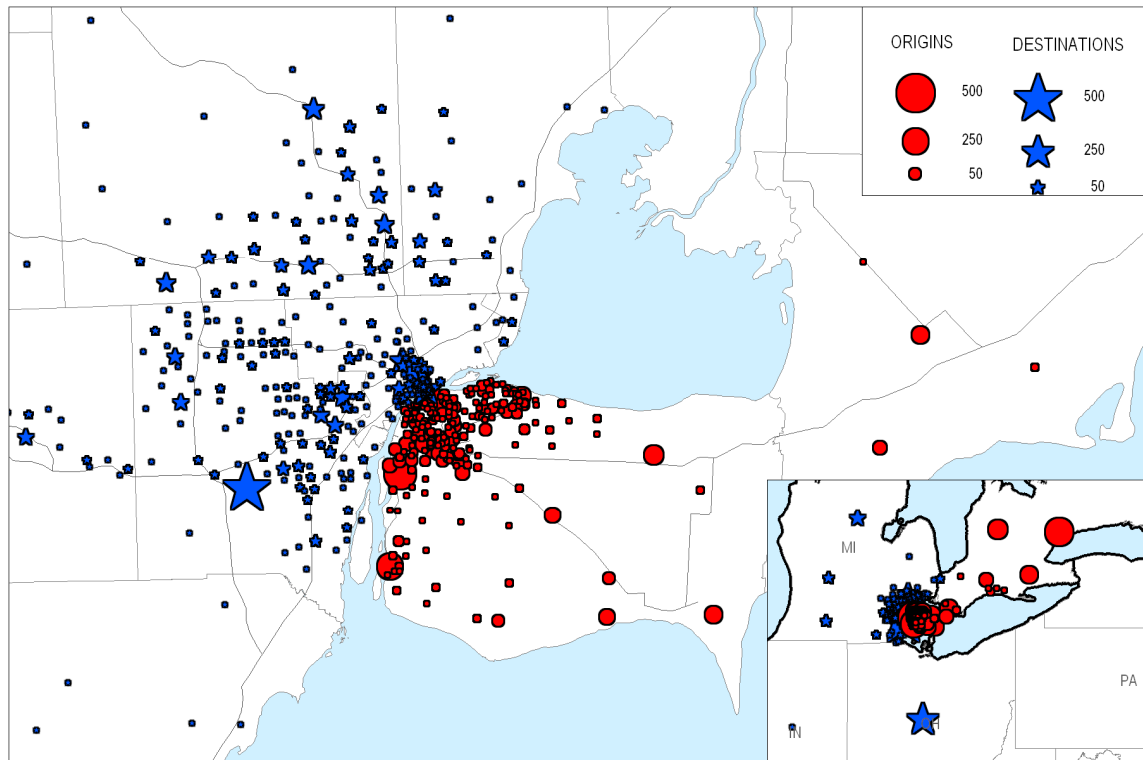
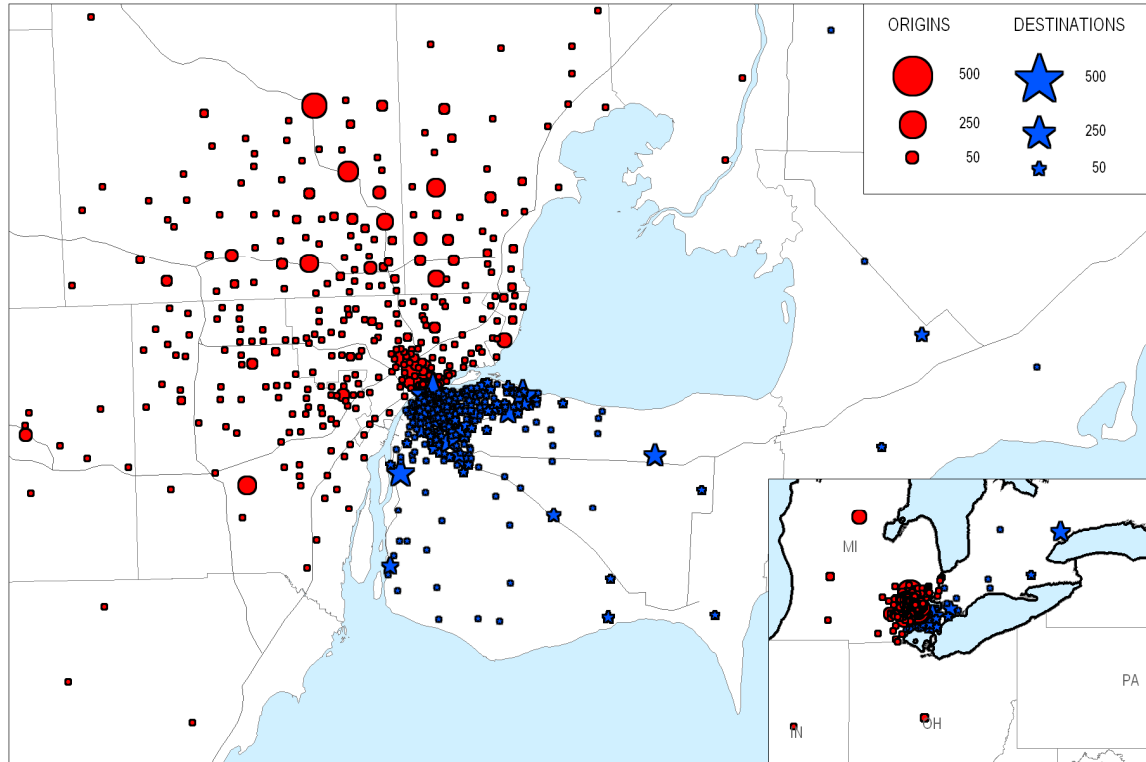


Exhibit 4-1 (Cont.): Weekday Passenger Car Trip Origins & Destinations, Spring 2008

C. Detroit-Windsor Tunnel, to Canada



D. Detroit-Windsor Tunnel, to US

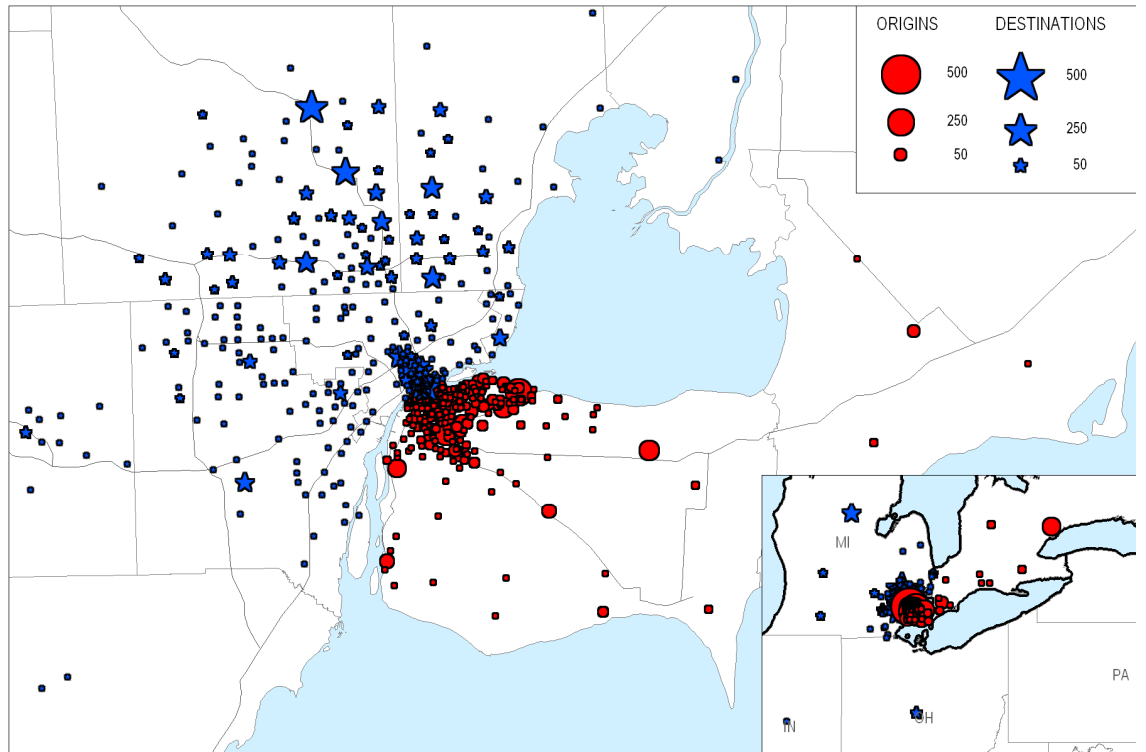
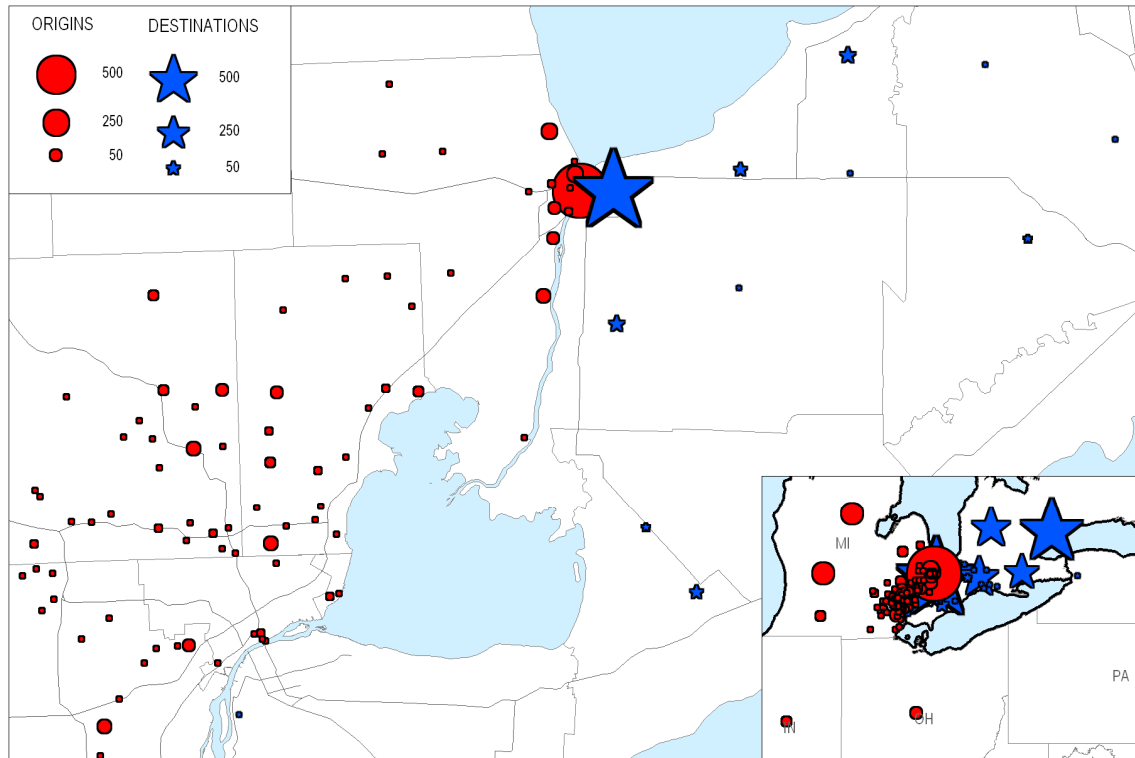


Exhibit 4-1 (Cont.): Weekday Passenger Car Trip Origins & Destinations, Spring 2008

E. Blue Water Bridge, to Canada



F. Blue Water Bridge, to US

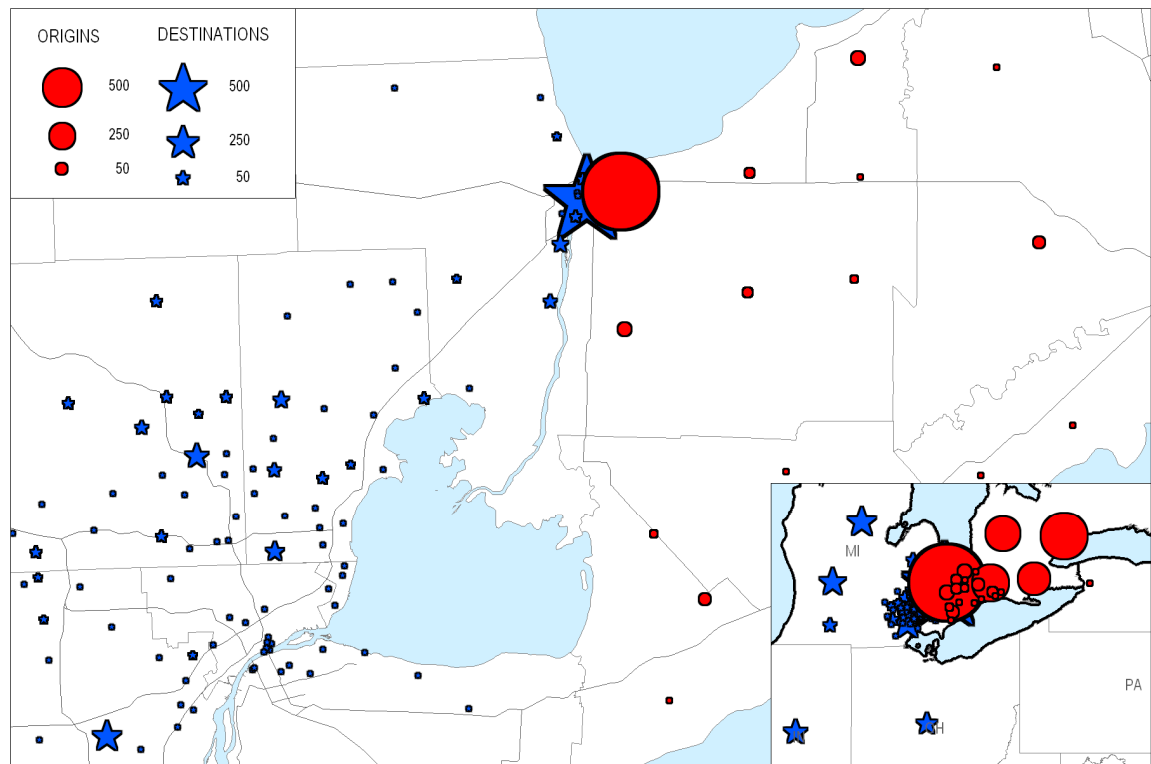


Exhibit 4-2: Superzone System (Ten Zone)

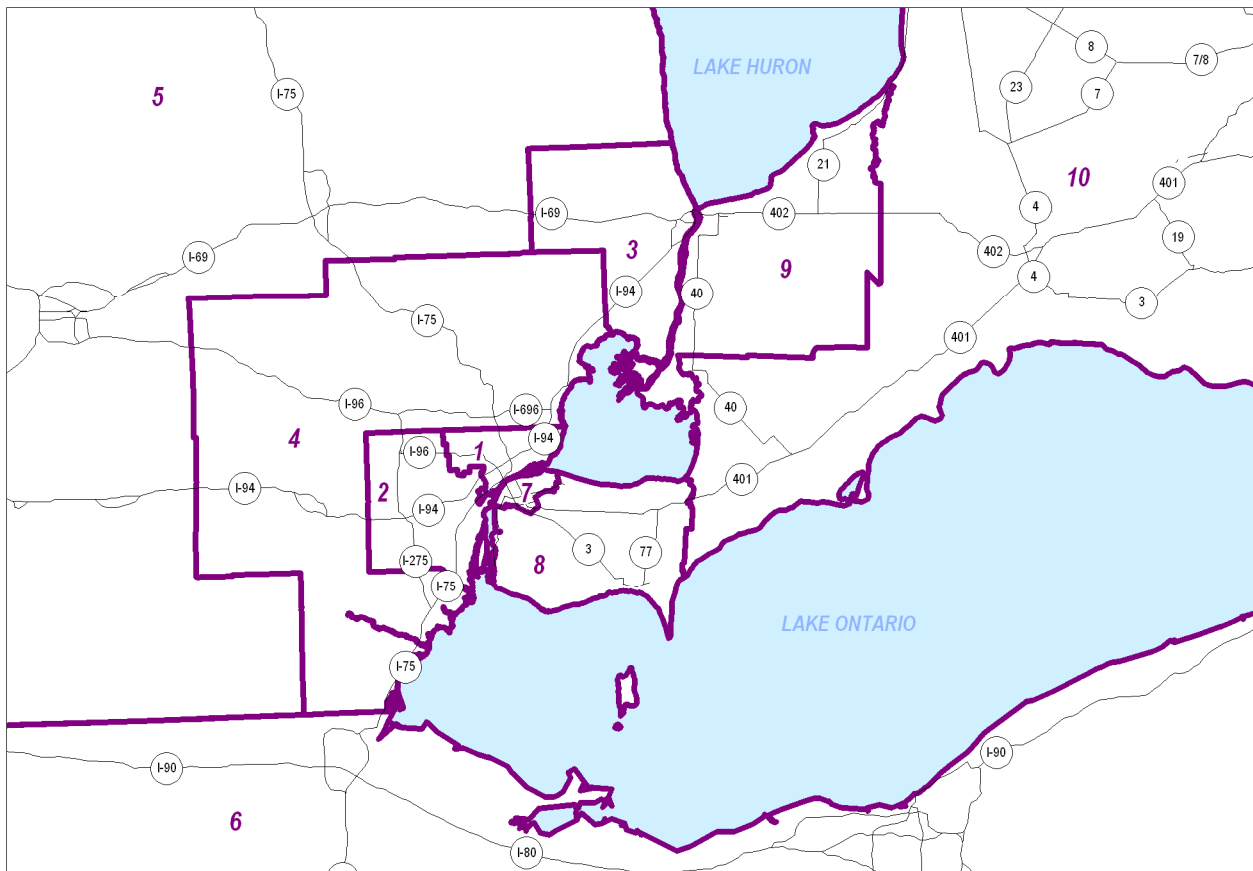


Exhibit 4-3: Weekday Passenger Car Trip Origin & Destination Matrices, Spring 2008

A. Ambassador Bridge, Trips

ORIGIN	DESTINATION										
	1	2	3	4	5	6	7	8	9	10	TOTAL
1 Detroit + NE Wayne							826	692		157	1,674
2 Rest of Wayne County						9	1,379	818		352	2,558
3 Port Huron/St. Clair County							19	12	9	8	48
4 Rest of SEMCOG							730	622		119	1,471
5 Rest of Michigan							95	35		52	181
6 Other USA/Mexico				28			223	162		813	1,225
7 Windsor	825	1,327	18	1,102	91	144				11	3,517
8 Rest of Essex County	849	815	5	784	46	141				6	2,646
9 Sarnia/Lambton County	9										9
10 Other Ontario/Canada	118	205		113	38	516	6			6	1,002
TOTAL	1,802	2,347	23	2,027	175	811	3,277	2,339	9	1,523	14,333

B. Ambassador Bridge, Proportion of Total Trips

ORIGIN	DESTINATION										
	1	2	3	4	5	6	7	8	9	10	TOTAL
1 Detroit + NE Wayne							6%	5%		1%	12%
2 Rest of Wayne County						0%	10%	6%		2%	18%
3 Port Huron/St. Clair County							0%	0%	0%	0%	0%
4 Rest of SEMCOG							5%	4%		1%	10%
5 Rest of Michigan							1%	0%		0%	1%
6 Other USA/Mexico				0%			2%	1%		6%	9%
7 Windsor	6%	9%	0%	8%	1%	1%				0%	25%
8 Rest of Essex County	6%	6%	0%	5%	0%	1%				0%	18%
9 Sarnia/Lambton County	0%										0%
10 Other Ontario/Canada	1%	1%		1%	0%	4%	0%			0%	7%
TOTAL	13%	16%	0%	14%	1%	6%	23%	16%	0%	11%	100%

Exhibit 4-3 (Cont.): Weekday Passenger Car Trip Origin & Destination Matrices, Spring 2008

C. Detroit-Windsor Tunnel, Trips

ORIGIN	DESTINATION										TOTAL
	1	2	3	4	5	6	7	8	9	10	
1 Detroit + NE Wayne						5	1,767	614	4	108	2,499
2 Rest of Wayne County							520	100		35	655
3 Port Huron/St. Clair County							35			2	37
4 Rest of SEMCOG							1,798	459		108	2,365
5 Rest of Michigan							86	16		14	115
6 Other USA/Mexico							59	16		17	92
7 Windsor	1,619	549	34	2,093	122	84			7	3	4,511
8 Rest of Essex County	637	95		499	21	20				3	1,275
9 Sarnia/Lambton County				5			7	3			14
10 Other Ontario/Canada	90	30	4	101	14	27					266
TOTAL	2,345	674	39	2,698	157	135	4,270	1,209	12	291	11,830

D. Detroit-Windsor Tunnel, Proportion of Total Trips

ORIGIN	DESTINATION										TOTAL
	1	2	3	4	5	6	7	8	9	10	
1 Detroit + NE Wayne						0%	15%	5%	0%	1%	21%
2 Rest of Wayne County							4%	1%		0%	6%
3 Port Huron/St. Clair County							0%			0%	0%
4 Rest of SEMCOG							15%	4%		1%	20%
5 Rest of Michigan							1%	0%		0%	1%
6 Other USA/Mexico							0%	0%		0%	1%
7 Windsor	14%	5%	0%	18%	1%	1%			0%	0%	38%
8 Rest of Essex County	5%	1%		4%	0%	0%				0%	11%
9 Sarnia/Lambton County				0%			0%	0%			0%
10 Other Ontario/Canada	1%	0%	0%	1%	0%	0%					2%
TOTAL	20%	6%	0%	23%	1%	1%	36%	10%	0%	2%	100%

Exhibit 4-3 (Cont.): Weekday Passenger Car Trip Origin & Destination Matrices, Spring 2008

E. Blue Water Bridge, Trips

ORIGIN	DESTINATION										TOTAL
	1	2	3	4	5	6	7	8	9	10	
1 Detroit + NE Wayne						18			17	60	96
2 Rest of Wayne County									38	174	212
3 Port Huron/St. Clair County						42			1,025	313	1,380
4 Rest of SEMCOG						118			127	598	844
5 Rest of Michigan						146		5	62	262	475
6 Other USA/Mexico	6	16	11	98	86	22			83	745	1,066
7 Windsor			5	18					16		40
8 Rest of Essex County											0
9 Sarnia/Lambton County	29	108	1,308	210	125	93	32	15		11	1,932
10 Other Ontario/Canada	68	237	354	638	330	639		11	11	83	2,371
TOTAL	103	361	1,679	964	541	1,078	32	31	1,379	2,247	8,415

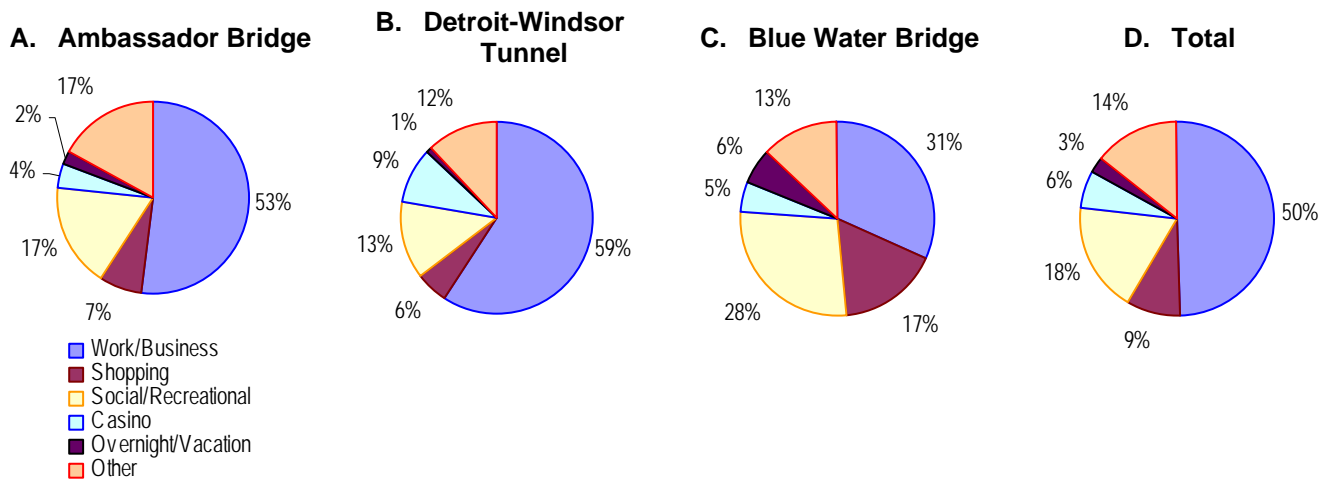
F. Blue Water Bridge, Proportion of Total Trips

ORIGIN	DESTINATION										TOTAL
	1	2	3	4	5	6	7	8	9	10	
1 Detroit + NE Wayne						0%			0%	1%	1%
2 Rest of Wayne County									0%	2%	3%
3 Port Huron/St. Clair County						0%			12%	4%	16%
4 Rest of SEMCOG						1%			2%	7%	10%
5 Rest of Michigan						2%		0%	1%	3%	6%
6 Other USA/Mexico	0%	0%	0%	1%	1%	0%			1%	9%	13%
7 Windsor			0%	0%					0%		0%
8 Rest of Essex County											0%
9 Sarnia/Lambton County	0%	1%	16%	2%	1%	1%	0%	0%		0%	23%
10 Other Ontario/Canada	1%	3%	4%	8%	4%	8%		0%	0%	1%	28%
TOTAL	1%	4%	20%	11%	6%	13%	0%	0%	16%	27%	100%

4.2 Trip Purposes

The differences in purpose of travel across each of the study crossings explains much of the differences in travel patterns shown above. Exhibit 4-4 illustrates the purpose breakdowns across an entire weekday. Much of the traffic at the Windsor-Detroit crossings is attributable to work/business travel, accounting for up to 60% of all travel. Linked to the very high proportion of local-to-local travel at the tunnel, the proportion is somewhat greater here given the direct downtown-to-downtown connection that exists. A significant number of Windsor residents commute to Detroit each day, given the draw of the city as a major employment center. The 2006 Canadian Census showed that almost 5% of employed workers in Windsor worked outside of Canada. Only 1.5% of Sarnia residents did the same, and it is likely that a significant proportion of these actually travel to Detroit also rather than to Port Huron.

Exhibit 4-4: Weekday Passenger Car Trip Purposes, Spring 2008



The discrepancy in work-related travel between the two areas is balanced by higher proportions of cross-border shopping and social-recreational travel, which account for almost 10% and 20% of travel in total.

Despite the presence of three casinos in Detroit, Canadian casinos in Windsor and Sarnia are still popular as winnings are tax-free. The Windsor Casino is closest to the tunnel, leading to a nearly 10% share of total daily traffic there, relative to about 5% in general.

The use of the crossings for longer-duration overnight vacation travel is less significant in April, after the March Break and before the summer vacation peaks. Travel for this purpose is most prominent at the Blue Water Bridge, likely due to the long-distance nature of this travel (allowing for greater flexibility in crossing choice), more scenic drives, less hectic drives, etc.

The purpose of travel varies considerably with the time of day, as shown in Exhibit 4-5, which shows the proportions of travel by trip purpose and time period. Not surprisingly, the morning and afternoon peak periods are dominated by work-related travel, although the mornings are even more so. Most discretionary travel occurs during the six-hour mid-day period,

Exhibit 4-5: Weekday Passenger Car Trips by Trip Purpose & Time Period, Spring 2008

A. Trips

Crossing	Time Period	Trip Purpose						Total
		Work/ Business	Shopping	Social/ Recreational	Casino	Overnight/ Vacation	Other	
Ambassador Bridge	AM Peak	2,030	30	140	20	30	200	2,470
	Mid-day	1,020	520	810	240	130	940	3,650
	PM peak	2,060	150	410	110	40	420	3,200
	Evening	710	170	500	110	40	320	1,840
	Night	750	60	350	50	60	270	1,530
	Total	6,580	930	2,210	530	300	2,150	12,690
Detroit-Windsor Tunnel	AM Peak	2,130	30	80	30	10	140	2,430
	Mid-day	1,450	390	500	420	50	580	3,390
	PM peak	2,460	130	370	280	20	320	3,580
	Evening	780	140	500	290	20	300	2,030
	Night	710	20	170	180	30	190	1,290
	Total	7,530	700	1,610	1,200	130	1,540	12,720
Blue Water Bridge	AM Peak	580	70	190	10	10	240	1,100
	Mid-day	970	800	990	160	120	480	3,520
	PM peak	810	400	690	120	220	210	2,440
	Evening	270	230	500	90	140	130	1,370
	Night	270	20	180	70	50	140	730
	Total	2,900	1,520	2,550	460	530	1,200	9,160
Total	AM Peak	4,750	140	410	60	50	580	6,000
	Mid-day	3,440	1,710	2,310	820	290	2,000	10,560
	PM peak	5,340	670	1,470	510	280	950	9,220
	Evening	1,760	540	1,490	500	200	750	5,250
	Night	1,720	100	690	300	140	600	3,550
	Total	17,010	3,150	6,370	2,190	970	4,890	34,570

Note: AM Peak is 6 a.m. to 9 a.m.; Mid-day is 9 a.m. to 3 p.m.; PM Peak is 3 p.m. to 7 p.m.; Evening is 7 p.m. to 11 p.m.; Night is 11 p.m. to 6 a.m.

Exhibit 4-5 (Cont.): Weekday Passenger Car Trips by Trip Purpose & Time Period, Spring 2008

B. Proportions By Trip Purpose

Crossing	Time Period	Trip Purpose						Total
		Work/ Business	Shopping	Social/ Recreational	Casino	Overnight/ Vacation	Other	
Ambassador Bridge	AM Peak	30.9%	3.7%	6.4%	4.0%	11.2%	9.4%	19.4%
	Mid-day	15.5%	56.1%	36.7%	44.7%	42.1%	43.6%	28.8%
	PM peak	31.4%	15.9%	18.7%	21.3%	13.1%	19.7%	25.2%
	Evening	10.8%	18.1%	22.6%	21.1%	12.3%	14.7%	14.5%
	Night	11.4%	6.1%	15.6%	8.8%	21.2%	12.6%	12.1%
	Total	100.0%	100.0%	100.0%	100.0%	100.0%	100.0%	100.0%
Detroit-Windsor Tunnel	AM Peak	28.3%	4.4%	5.0%	2.4%	11.2%	9.3%	19.1%
	Mid-day	19.2%	55.9%	31.1%	35.1%	34.8%	37.9%	26.7%
	PM peak	32.7%	17.8%	22.9%	23.0%	16.9%	20.8%	28.1%
	Evening	10.4%	19.3%	30.7%	24.3%	17.4%	19.7%	16.0%
	Night	9.4%	2.6%	10.3%	15.1%	19.7%	12.3%	10.1%
	Total	100.0%	100.0%	100.0%	100.0%	100.0%	100.0%	100.0%
Blue Water Bridge	AM Peak	20.1%	4.7%	7.5%	2.8%	1.1%	19.8%	12.0%
	Mid-day	33.4%	52.4%	39.0%	34.7%	22.8%	39.9%	38.4%
	PM peak	27.8%	26.2%	27.0%	26.1%	40.7%	17.6%	26.7%
	Evening	9.4%	15.3%	19.6%	20.6%	26.5%	10.7%	15.0%
	Night	9.2%	1.4%	6.9%	15.8%	9.0%	12.0%	7.9%
	Total	100.0%	100.0%	100.0%	100.0%	100.0%	100.0%	100.0%
Total	AM Peak	27.9%	4.4%	6.5%	2.9%	5.6%	11.9%	17.3%
	Mid-day	20.2%	54.3%	36.2%	37.4%	30.4%	40.9%	30.6%
	PM peak	31.4%	21.3%	23.1%	23.2%	28.9%	19.5%	26.7%
	Evening	10.4%	17.0%	23.5%	22.8%	20.9%	15.3%	15.2%
	Night	10.1%	3.0%	10.8%	13.7%	14.2%	12.3%	10.3%
	Total	100.0%	100.0%	100.0%	100.0%	100.0%	100.0%	100.0%

Note: AM Peak is 6 a.m. to 9 a.m.; Mid-day is 9 a.m. to 3 p.m.; PM Peak is 3 p.m. to 7 p.m.; Evening is 7 p.m. to 11 p.m.; Night is 11 p.m. to 6 a.m.

Exhibit 4-5 (Cont.): Weekday Passenger Car Trips by Trip Purpose & Time Period, Spring 2008

C. Proportions By Time Period

Crossing	Time Period	Trip Purpose						Total
		Work/ Business	Shopping	Social/ Recreational	Casino	Overnight/ Vacation	Other	
Ambassador Bridge	AM Peak	82.5%	1.4%	5.7%	0.9%	1.4%	8.2%	100.0%
	Mid-day	27.9%	14.3%	22.2%	6.4%	3.4%	25.7%	100.0%
	PM peak	64.5%	4.6%	12.9%	3.5%	1.2%	13.2%	100.0%
	Evening	38.6%	9.1%	27.0%	6.0%	2.0%	17.2%	100.0%
	Night	48.9%	3.7%	22.6%	3.0%	4.1%	17.7%	100.0%
	Total	51.8%	7.3%	17.4%	4.2%	2.3%	17.0%	100.0%
Detroit-Windsor Tunnel	AM Peak	87.7%	1.3%	3.4%	1.2%	0.6%	5.9%	100.0%
	Mid-day	42.7%	11.6%	14.8%	12.4%	1.4%	17.2%	100.0%
	PM peak	68.9%	3.5%	10.3%	7.7%	0.6%	9.0%	100.0%
	Evening	38.4%	6.7%	24.4%	14.4%	1.1%	15.0%	100.0%
	Night	54.9%	1.4%	12.8%	14.1%	2.0%	14.8%	100.0%
	Total	59.2%	5.5%	12.7%	9.4%	1.0%	12.1%	100.0%
Blue Water Bridge	AM Peak	52.9%	6.5%	17.4%	1.2%	0.5%	21.5%	100.0%
	Mid-day	27.6%	22.6%	28.2%	4.5%	3.5%	13.6%	100.0%
	PM peak	33.1%	16.3%	28.2%	4.9%	8.9%	8.6%	100.0%
	Evening	19.9%	17.0%	36.5%	6.9%	10.3%	9.4%	100.0%
	Night	36.7%	2.9%	24.1%	10.0%	6.6%	19.7%	100.0%
	Total	31.7%	16.6%	27.8%	5.0%	5.8%	13.1%	100.0%
Total	AM Peak	79.1%	2.3%	6.9%	1.1%	0.9%	9.7%	100.0%
	Mid-day	32.6%	16.2%	21.8%	7.7%	2.8%	18.9%	100.0%
	PM peak	57.9%	7.3%	15.9%	5.5%	3.0%	10.4%	100.0%
	Evening	33.6%	10.2%	28.5%	9.5%	3.8%	14.3%	100.0%
	Night	48.6%	2.7%	19.4%	8.5%	3.9%	17.0%	100.0%
	Total	49.2%	9.1%	18.4%	6.3%	2.8%	14.1%	100.0%

Note: AM Peak is 6 a.m. to 9 a.m.; Mid-day is 9 a.m. to 3 p.m.; PM Peak is 3 p.m. to 7 p.m.; Evening is 7 p.m. to 11 p.m.; Night is 11 p.m. to 6 a.m.

4.3 Other Travel Characteristics

While travel origin-destination and trip purpose were the focus of the survey, other information was collected as well. Exhibit 4-6 shows the occupancy (i.e., number of persons per vehicle) by crossing, while Exhibit 4-7 illustrates the trip frequency. The results are consistent with the travel pattern and purpose characteristics described above. Single-occupant vehicles from commuter work-related travel highest at the tunnel and multi-occupant vehicles from discretionary travel more pronounced at the Blue Water Bridge. Similarly, daily trip frequencies from commuter travel are highest at the tunnel and lowest at the Blue Water Bridge. Exhibits 4-8 and 4-9 describe membership in the NEXUS program and the method of payment used, respectively.

Exhibit 4-6: Weekday Passenger Car Occupancy, Spring 2008

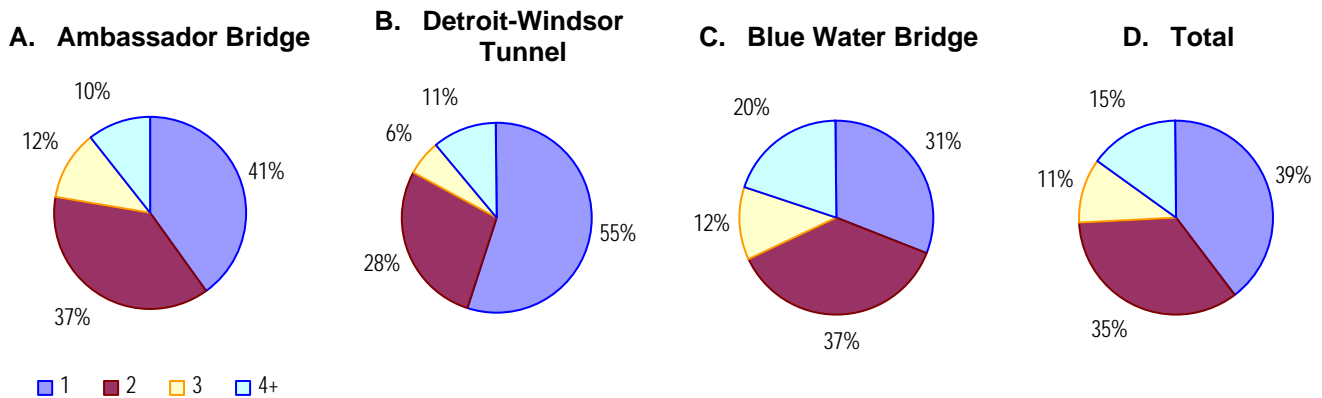


Exhibit 4-7: Weekday Passenger Car Trip Frequency, Spring 2008

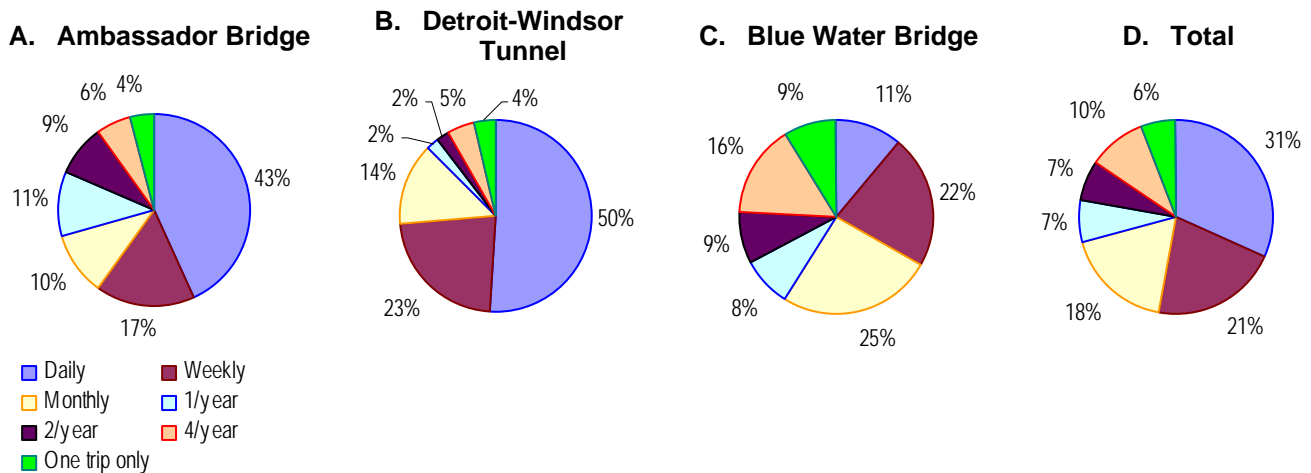


Exhibit 4-8: Weekday Passenger Car Nexus Membership, Spring 2008

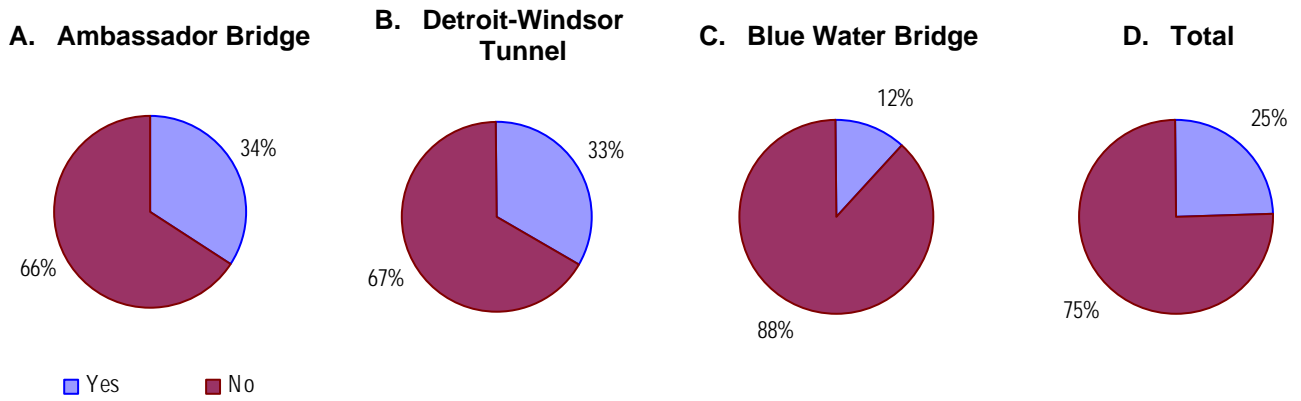
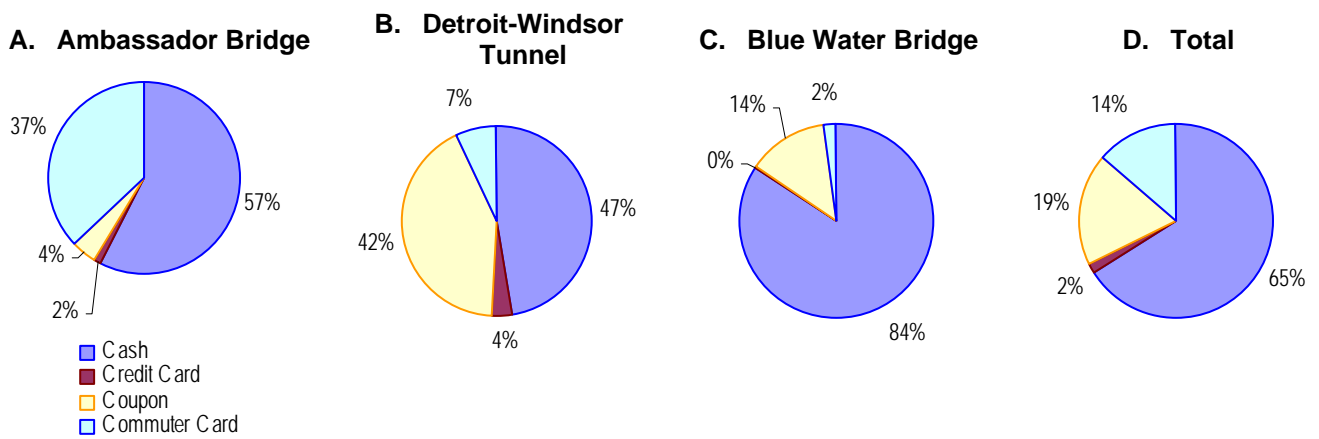


Exhibit 4-9: Weekday Passenger Car Payment Method, Spring 2008



4.4 2000 to 2008 Trends

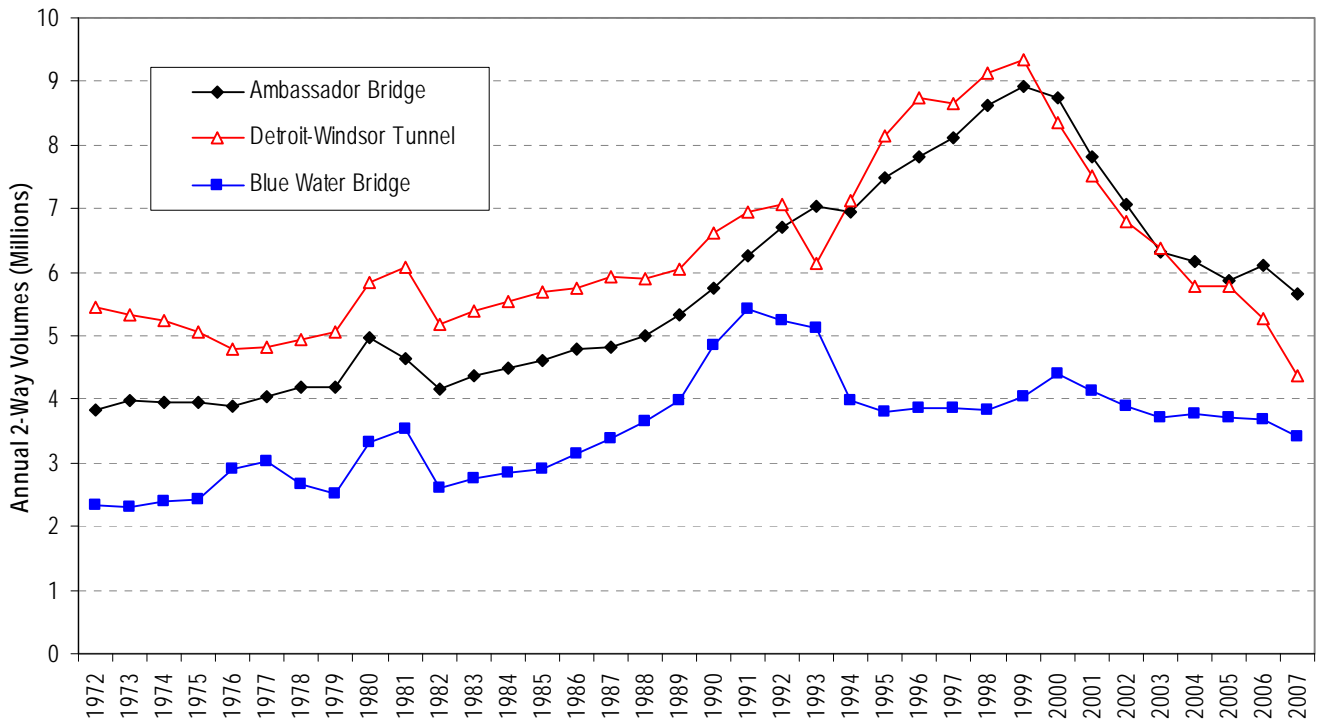
As noted above, the passenger car survey conducted for this study is similar to the survey conducted for the 2000 Ontario-Michigan Border Crossing Traffic Study. That survey was conducted in August and thus represents travel characteristics consistent with summer months, during which there generally is a significantly larger proportion of vacation travel, and to different vacation destinations, relative to when this survey was conducted.

Having acknowledged this seasonal variation, it is still useful to compare the two in order to investigate the trends in travel characteristics between 2000 and 2008. A lot of socio-economically significant events have occurred since 2000 that have greatly affected these characteristics and the associated volumes of car traffic observed on the crossings, including:

- **Opening of Detroit casinos** – The MGM Grand Detroit opened in July of 1999, effectively ending the need for Detroit and other US residents to cross the border to gamble at Casino Windsor, which opened in 1994. Two other casinos now also exist in Detroit. While Canadian casinos still enjoy an advantage in that the winnings are tax-free, the opening of these casinos has had a noticeable and permanent impact on discretionary traffic volumes;
- **Tech-bubble burst** – The economy took a significant downturn in 2000 after very strong growth in the 1990s from the “dot-com” boom. While the attraction of Detroit as an employment center for Windsor residents had remained stable until 2006, this likely affected the amount of disposable income and the willingness of travellers to cross the border to shop;
- **9/11 and Iraq War** – These two related events have impacted the ease with which travellers can cross the border and, likely, the propensity for international discretionary travel;
- **SARS epidemic in Toronto** – In 2003, the city, a popular tourist destination for Americans, was one of several global locations of the highly-publicized epidemic. Impacts on tourism and vacation trips across the border were immediate;
- **Increase in value of Canadian dollar** – In 2007, the value of the Canadian dollar hit parity with the US dollar for the first time since the mid-1970s. While this makes travel to the US more attractive for Canadians, it has the opposite effect for travel to Canada for Americans. From a work commuting perspective, the incentive for Canadians to work in the US will have decreased with this event, however there would be a lag effect and it is too soon to quantify any permanent changes; and
- **Increase in gasoline prices** – Particularly in the last few years, the price has risen geometrically, making work-related and, particularly, discretionary travel increasingly less attractive/economically feasible.

The extreme impacts of these events on annual crossing volumes are shown in Exhibit 4-10. Since 2000, passenger car traffic volumes have decreased by 35%, 48% and 22% at the Ambassador Bridge, Detroit-Windsor Tunnel and Blue Water Bridge, respectively.

Exhibit 4-10: Annual Passenger Car Traffic Volumes, 1972 to 2007



Source: PBOA

Exhibits 4-11 and 4-12 present the 2000 (summer) to 2008 (spring) trends in travel patterns and trip purpose for each of the three study crossings. In general, the trends are consistent with the set of events described above, which have impacted discretionary travel more so than work-related travel. This can be seen in the changes in trip purpose; that is, the number of work-purpose trips have decreased much less (therefore growing in proportion) over the period than the other trip purposes. For both Detroit-Windsor crossings combined, and again acknowledging the effects of seasonal variation, work-related travel has decreased by 16% while the total number of trips has decreased by half. In terms of the travel patterns, as work travel is mostly local-to-local, the changes in this trip interchange have been somewhat less than the others, gaining six points of the share of total traffic. A similar finding can be seen at the Blue Water Bridge.

Exhibit 4-11: Weekday Passenger Car Travel Pattern Trends, Summer 2000 to Spring 2008

Crossing	Trip Interchange	Summer 2000		Spring 2008		2000 to 2008 Change		
		Trips	Prop.	Trips	Prop.	Trips	%	Prop.
Ambassador Bridge	Local to Local	18,470	70%	11,200	78%	-7,270	-39%	8%
	Local (US) to/from Long Distance	2,170	8%	730	5%	-1,440	-66%	-3%
	Local (Canada) to/from Long Distance	2,940	11%	1,090	8%	-1,850	-63%	-4%
	Long Distance to Long Distance	2,770	11%	1,310	9%	-1,460	-53%	-1%
	<i>Total</i>	<i>26,350</i>	<i>100%</i>	<i>14,330</i>	<i>100%</i>	<i>-12,020</i>	<i>-46%</i>	<i>0%</i>
Detroit-Windsor Tunnel	Local to Local	22,080	88%	10,960	93%	-11,120	-50%	5%
	Local (US) to/from Long Distance	970	4%	310	3%	-660	-68%	-1%
	Local (Canada) to/from Long Distance	1,940	8%	520	4%	-1,420	-73%	-3%
	Long Distance to Long Distance	240	1%	40	0%	-200	-83%	-1%
	<i>Total</i>	<i>25,230</i>	<i>100%</i>	<i>11,830</i>	<i>100%</i>	<i>-13,400</i>	<i>-53%</i>	<i>0%</i>
Detroit-Windsor Crossings	Local to Local	40,550	79%	22,160	85%	-18,390	-45%	6%
	Local (US) to/from Long Distance	3,140	6%	1,040	4%	-2,100	-67%	-2%
	Local (Canada) to/from Long Distance	4,880	9%	1,610	6%	-3,270	-67%	-3%
	Long Distance to Long Distance	3,010	6%	1,350	5%	-1,660	-55%	-1%
	<i>Total</i>	<i>51,580</i>	<i>100%</i>	<i>26,160</i>	<i>100%</i>	<i>-25,420</i>	<i>-49%</i>	<i>0%</i>
Blue Water Bridge	Local to Local	6,090	43%	2,700	32%	-3,390	-56%	-11%
	Local (US) to/from Long Distance	2,710	19%	2,140	25%	-570	-21%	6%
	Local (Canada) to/from Long Distance	1,810	13%	650	8%	-1,160	-64%	-5%
	Long Distance to Long Distance	3,490	25%	2,920	35%	-570	-16%	10%
	<i>Total</i>	<i>14,100</i>	<i>100%</i>	<i>8,410</i>	<i>100%</i>	<i>-5,690</i>	<i>-40%</i>	<i>0%</i>
Total	Local to Local	46,640	71%	24,860	72%	-21,780	-47%	1%
	Local (US) to/from Long Distance	5,850	9%	3,180	9%	-2,670	-46%	0%
	Local (Canada) to/from Long Distance	6,690	10%	2,260	7%	-4,430	-66%	-4%
	Long Distance to Long Distance	6,500	10%	4,270	12%	-2,230	-34%	2%
	<i>Total</i>	<i>65,680</i>	<i>100%</i>	<i>34,570</i>	<i>100%</i>	<i>-31,110</i>	<i>-47%</i>	<i>0%</i>

Note: For the Ambassador Bridge and Detroit-Windsor Tunnel, a "local" trip end refers to Essex and Kent Counties in Ontario, and the SEMCOG area excluding St. Clair County in Michigan. For the Blue Water Bridge, a "local" trip end refers to Lambton County in Ontario, and St. Clair, Macomb, Oakland and Livingston Counties in Michigan.

Exhibit 4-12: Weekday Passenger Car Trip Purpose Trends, Summer 2000 to Spring 2008

Crossing	Trip Purpose	Summer 2000		Spring 2008		2000 to 2008 Change		
		Trips	Prop.	Trips	Prop.	Trips	%	Prop.
Ambassador Bridge	Work/Business	8,920	34%	7,430	52%	-1,490	-17%	18%
	Shopping & Recreation	10,970	42%	4,140	29%	-6,830	-62%	-13%
	Vacation	2,880	11%	340	2%	-2,540	-88%	-9%
	Other	3,580	14%	2,430	17%	-1,150	-32%	3%
	<i>Total</i>	<i>26,350</i>	<i>100%</i>	<i>14,340</i>	<i>100%</i>	<i>-12,010</i>	<i>-46%</i>	<i>0%</i>
Detroit-Windsor Tunnel	Work/Business	8,350	33%	7,000	59%	-1,350	-16%	26%
	Shopping & Recreation	12,750	51%	3,270	28%	-9,480	-74%	-23%
	Vacation	920	4%	120	1%	-800	-87%	-3%
	Other	3,220	13%	1,430	12%	-1,790	-56%	-1%
	<i>Total</i>	<i>25,240</i>	<i>100%</i>	<i>11,820</i>	<i>100%</i>	<i>-13,420</i>	<i>-53%</i>	<i>0%</i>
Detroit-Windsor Crossings	Work/Business	17,270	33%	14,430	55%	-2,840	-16%	22%
	Shopping & Recreation	23,720	46%	7,410	28%	-16,310	-69%	-18%
	Vacation	3,800	7%	460	2%	-3,340	-88%	-6%
	Other	6,800	13%	3,860	15%	-2,940	-43%	2%
	<i>Total</i>	<i>51,590</i>	<i>100%</i>	<i>26,160</i>	<i>100%</i>	<i>-25,430</i>	<i>-49%</i>	<i>0%</i>
Blue Water Bridge	Work/Business	3,120	22%	2,670	32%	-450	-14%	10%
	Shopping & Recreation	6,170	44%	4,160	49%	-2,010	-33%	6%
	Vacation	1,990	14%	490	6%	-1,500	-75%	-8%
	Other	2,820	20%	1,100	13%	-1,720	-61%	-7%
	<i>Total</i>	<i>14,100</i>	<i>100%</i>	<i>8,420</i>	<i>100%</i>	<i>-5,680</i>	<i>-40%</i>	<i>0%</i>
Total	Work/Business	20,390	31%	17,100	49%	-3,290	-16%	18%
	Shopping & Recreation	29,890	46%	11,570	33%	-18,320	-61%	-12%
	Vacation	5,790	9%	950	3%	-4,840	-84%	-6%
	Other	9,620	15%	4,960	14%	-4,660	-48%	0%
	<i>Total</i>	<i>65,690</i>	<i>100%</i>	<i>34,580</i>	<i>100%</i>	<i>-31,110</i>	<i>-47%</i>	<i>0%</i>

5. COMMERCIAL VEHICLE TRAVEL

5.1 Data Sources

Information relating to international commercial vehicle traffic was available from two primary sources:

- Preliminary 2006 National Roadside Survey (NRS) data, provided by Transport Canada. This is a thorough roadside intercept survey of truck traffic throughout Canada, collecting a significant amount of information about the vehicle, commodities carried, carrier, driver, and the current trip being made; and
- One-week automated traffic counts, implemented for the passenger car travel survey, providing vehicle classification information at the three crossings and on major freeway facilities.

The 2006 NRS had data collection sites at both of the Ambassador Bridge and the Blue Water Bridge for both directions of international traffic in October and November of 2006. While a site also existed at the Detroit-Windsor Tunnel in the 2000 survey, it was not implemented in 2006. The data provided contains the following information:

- Border crossing used, identified either by the location of the data collection site and/or a separate field that indicated the reported crossing used;
- Truck configuration, body style and weight;
- Commodity transported (if any) and weight;
- Origin and destination coordinates (longitude and latitude);
- Date and time at survey site and location;
- Company type (i.e., private or for-hire); and
- Estimated date and time of departure from origin and arrival to destination.

As such, the data contains records for trips intercepted right at the border for the two study bridges as well as records for trips that reported crossing at one of the three study crossings, intercepted at other data collection sites throughout the country.

Given data expansion requirements and the need to sample all truck traffic using a crossing, it was desirable to use only trip records from the data collection sites located directly at the border crossings. As there was no site located at the tunnel crossing, the reported crossing information was investigated. In addition to introducing data expansion difficulties, it was found that the use of this information provided a very poor representation of the travel characteristics at the tunnel (as are known from the 2000 survey data). In effect, because there were no other data collection sites in the Windsor area, no short-distance trips (i.e., the majority of trips using the tunnel) were captured. As such, it was concluded that the 2006 data were not sufficient for representing truck travel in the tunnel. Therefore, no analysis of the 2006 data are presented here. For the tunnel, data from the 2000 survey are used to create truck trip matrices for the travel demand model.

5.2 Data Processing & Expansion

The NRS database contains a total of 3,931 trip records that were intercepted at the data collection sites located at the Ambassador Bridge and Blue Water Bridge. Similar to the passenger car data cleaning process, checks were made to identify which trip records were useable. The criteria used to determine whether a record would be used include:

- **Valid crossing time** – Required for data expansion purposes;
- **Valid commodity type** – Used to stratify the travel demand model trip matrices; and
- **Valid information for assigning traffic zones** – Longitude and latitude coordinates provided in the data are required to assign origin and destination zones.

No records were found to have missing data or coordinates. The records were then assigned a traffic zone using the origin and destination longitude and latitude coordinates provided for each record. Trip trajectories were then checked manually considering origin, destination and crossing used. No illogical trips were identified.

The data were then expanded using the truck traffic counts implemented in April and June, 2008, at each crossing by direction. Since none of the trip records were discarded, all 3,931 were expanded to represent the final sample. As the records were obtained from data collection sites located at the crossings, the crossing time was considered to be equivalent to the survey time. A summary of the results of expansion is shown in Exhibit 5-1. The factors range from 1.6 to 11.2, with a mean value of 4.9 and a median value of 4.5. Thus, the survey captured about 23% of the daily truck traffic at these two crossings combined. The 11.2 value corresponding to the evening period into Canada at the Ambassador Bridge is the only factor over 10.

Exhibit 5-1: Commercial Vehicle Survey Expansion Factors

Crossing	Period	Into Canada			Into US		
		Count	Records	Exp. Factor	Count	Records	Exp. Factor
Ambassador Bridge	Night	1,188	137	8.7	1,250	329	3.8
	AM Peak	562	78	7.2	880	137	6.4
	Mid-day	1,729	247	7.0	1,735	491	3.5
	PM Peak	1,237	135	9.2	1,204	275	4.4
	Evening	1,048	94	11.2	1,036	227	4.6
	<i>Total¹</i>	<i>5,764</i>	<i>691</i>	<i>8.3</i>	<i>6,104</i>	<i>1,459</i>	<i>4.2</i>
Blue Water Bridge	Night	503	179	2.8	392	246	1.6
	AM Peak	344	62	5.6	271	98	2.8
	Mid-day	998	211	4.7	670	326	2.1
	PM Peak	590	122	4.8	465	228	2.0
	Evening	466	124	3.8	320	185	1.7
	<i>Total¹</i>	<i>2,900</i>	<i>698</i>	<i>4.2</i>	<i>2,117</i>	<i>1,083</i>	<i>2.0</i>

¹ Total factors presented for interest only; they are not used in data expansion.

Finally, the number of axles, required to determine the toll rate at the Blue Water Bridge, was determined for each trip record based on the truck configuration.

5.3 Impact of Ambassador Gateway Project

As with the impacts on passenger cars discussed in Section 3.8, this construction would potentially have led to delays for truck traffic at the bridge and subsequent impacts on trip volumes and choice of crossing. A similar analysis was undertaken to quantify any impacts, with the results presented in Exhibit 5-2.

In terms of trip generation/volumes, it is much more unlikely that overall commercial vehicle traffic volumes would be reduced relative to passenger car traffic, which is comprised of a significant proportion of discretionary/optional travel. The results so show that there was a significant reduction in the number of trips at the study crossings in March, although the total volume at all Ontario crossings combined was also well below the trend. Part of the reason for this is that there were two fewer weekdays in March 2008 relative to the normal number of 23, explaining a reduction in volume of up to 9%. However, as there was an increase back to the four-year trend at the other Ontario crossings in March, it appears that there was indeed a diversion of truck traffic from the study crossings to them.

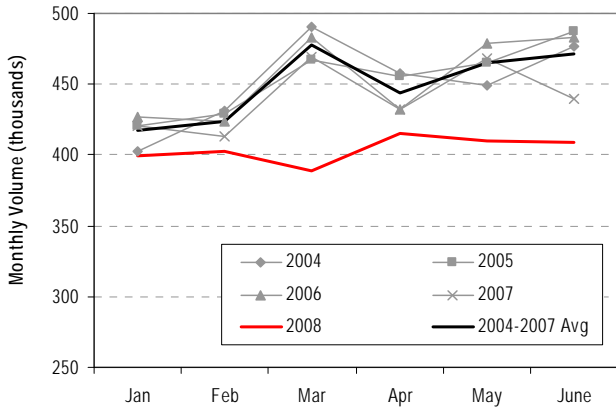
However, as the passenger car survey and traffic counts were conducted in April, this is the month of focus. By this time, it appears that much of the diverted traffic had returned to the study crossings, perhaps as it became known that the construction was not resulting in significant travel time delays. However, it appears that there was still a slight shortfall of traffic volumes from the norm.

In terms of the diversion of traffic to the two other crossings within the study area, there was no significant change in the share of traffic at the Ambassador Bridge over the construction period, indicating that there was little or no diversion to the other two study crossings.

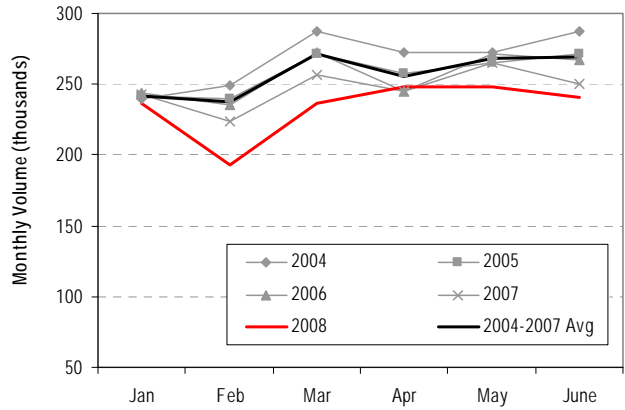
Two different approaches, shown in Exhibit 5-3, were taken to quantifying the shortfall of traffic at the study crossings and any potential correction. The first approach assumes that the shortfall in traffic from the four-year trend observed in the early months of 2008, about 5%, would exist in April as well without the construction. However, as the April shortfall was only about 6.5%, a correction of about 1.6% is required to restore the volumes. The second approach assumes that the proportion of the four-year average volume on the study crossings of that of all Ontario crossings, 63.5% in the month of April, is maintained in April, 2008. This approach results in a correction of only 1.5%. Given that the two approaches support each other and that they are within the range of error of the count data itself, no correction is needed for the commercial vehicle counts and survey data.

Exhibit 5-2: Impact of Ambassador Gateway Project on Monthly Commercial Vehicle Traffic Trends, 2004 to 2008

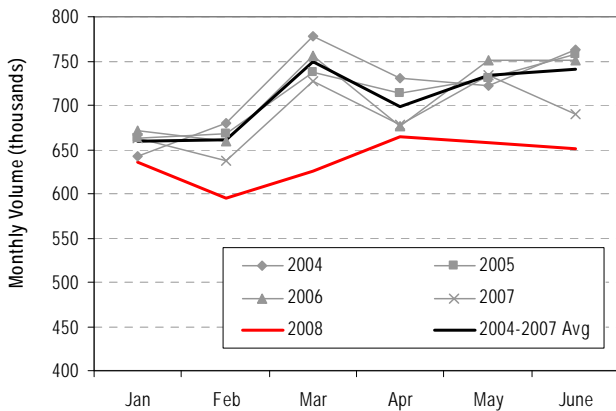
A. Total Traffic Volumes on Study Crossings



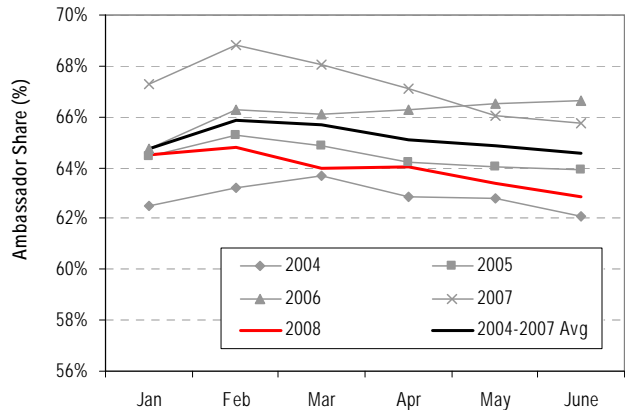
B. Total Traffic Volumes on Other Ontario Crossings



C. Total Traffic Volumes on All Ontario Crossings



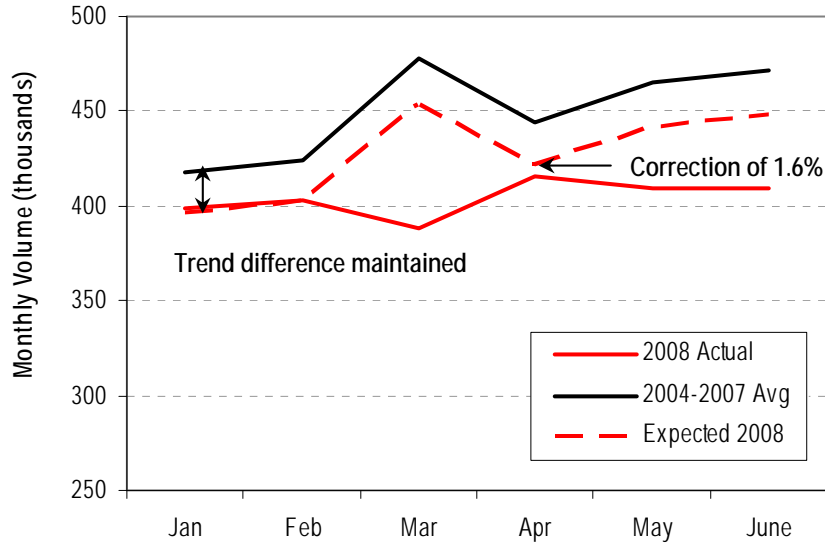
D. Ambassador Bridge Share of Total Study Crossing Volumes



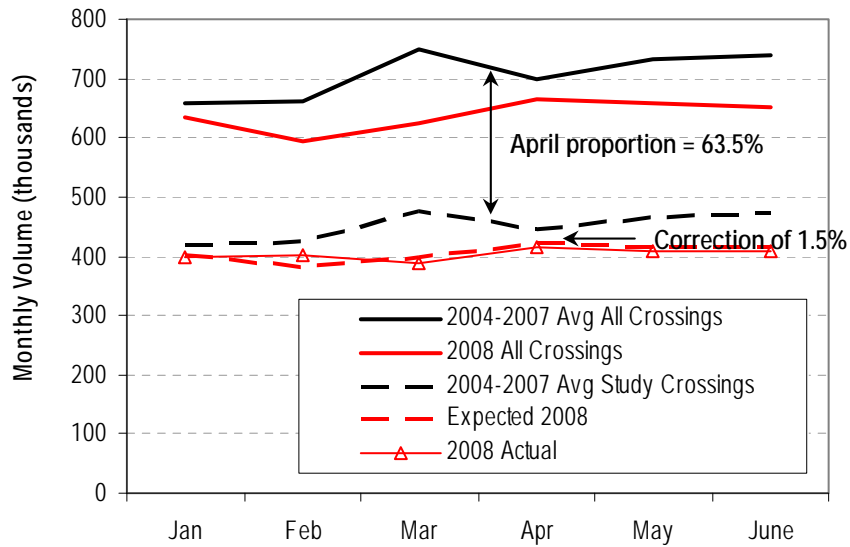
Source: PBOA

Exhibit 5-3: Expected 2008 Study Crossing Commercial Vehicle Traffic

A. Approach #1



B. Approach #2



5.4 Summary Results

The following presents summary results using information obtained from the NRS collected in October/November 2006, expanded to the total volumes at each crossing in April 2008 by time period and direction of travel.

5.4.1 TRIP ORIGIN-DESTINATION PATTERNS

The spatial distribution of the commercial vehicle trip origins and trip destinations is presented in Exhibit 5-4 for each crossing, by direction of crossing. Exhibit 5-5 shows the number of trips and proportions using the travel origin-destination superzones defined in Exhibit 4-2. More disaggregate matrices are presented as Appendix C.

The **Ambassador Bridge** services the vast majority of truck travel in the study area, carrying about 11,900 trucks on an average weekday. Given the strong industrial economies in both Detroit and Windsor (represented mainly by the automotive sector) and the ties between them, the crossing serves a large number of local truck movements in addition to the long-distance through traffic more typical of international crossings. Twenty-one percent of trips have a trip end in Wayne County and 28% have a trip end in Essex County, while about 9% of traffic is entirely between these areas.

Average weekday truck volumes on the **Blue Water Bridge** are less than half of the Ambassador Bridge at about 5,000. As Sarnia and Port Huron do not have the same industrial economies and ties as Windsor-Detroit, the proportion of local travel is also significantly less: 6% of trips have a trip end in St. Clair County, 11% have an end in Lambton County and only 1% is entirely between these areas.

Just over half of trips at the Ambassador Bridge are entirely long-distance through travel, while almost two-thirds of trips at the Blue Water Bridge are. On the Canadian side, the trips are generated from the industrial nodes along the Québec-Windsor Corridor, consisting mainly of Montreal and the Greater Toronto Area and connected by Highway 401. On the US side, the trips are generated from a much broader distribution of places, concentrated in the Great Lakes states (of Ohio, Indiana, Illinois and Wisconsin) but also from as far away as Texas and California.

Less than 2% of these commercial vehicle trips start and end the trip in the US and are referred to as in-transit trips. The majority of these trips involve travel between Michigan and Western New York where the travel distance to travel through Canada is significantly shorter than travelling entirely within the US by a routing south of Lake Erie. Approximately 3% of the truck traffic at the Blue Water Bridge is in-transit, compared to 1% at the Ambassador Bridge.

Exhibit 5-4: Weekday Commercial Vehicle Trip Origins & Destinations, Fall 2008

A. Ambassador Bridge, To Canada

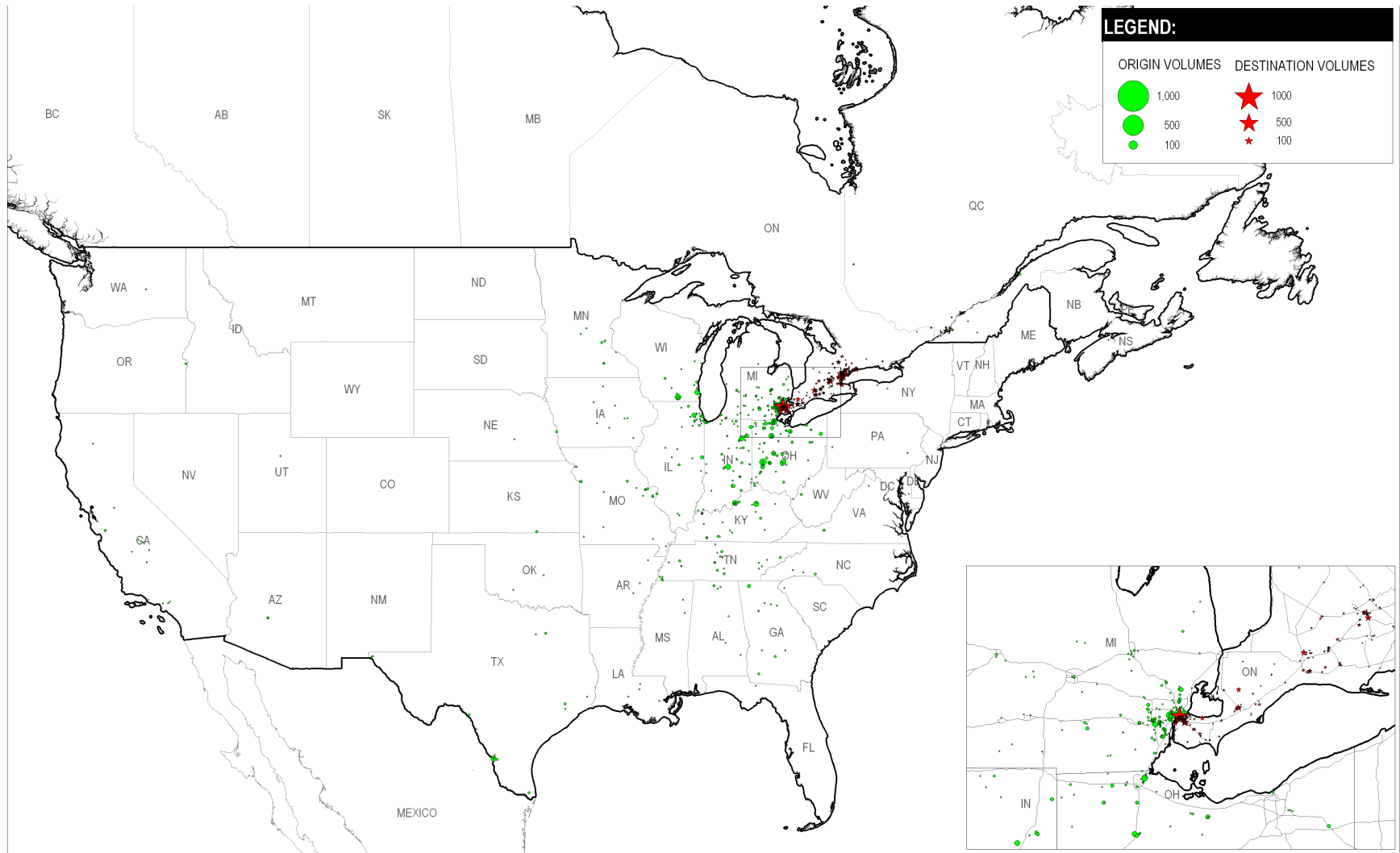


Exhibit 5-4 (Cont.): Weekday Commercial Vehicle Trip Origins & Destinations, Fall 2008

B. Ambassador Bridge, To US

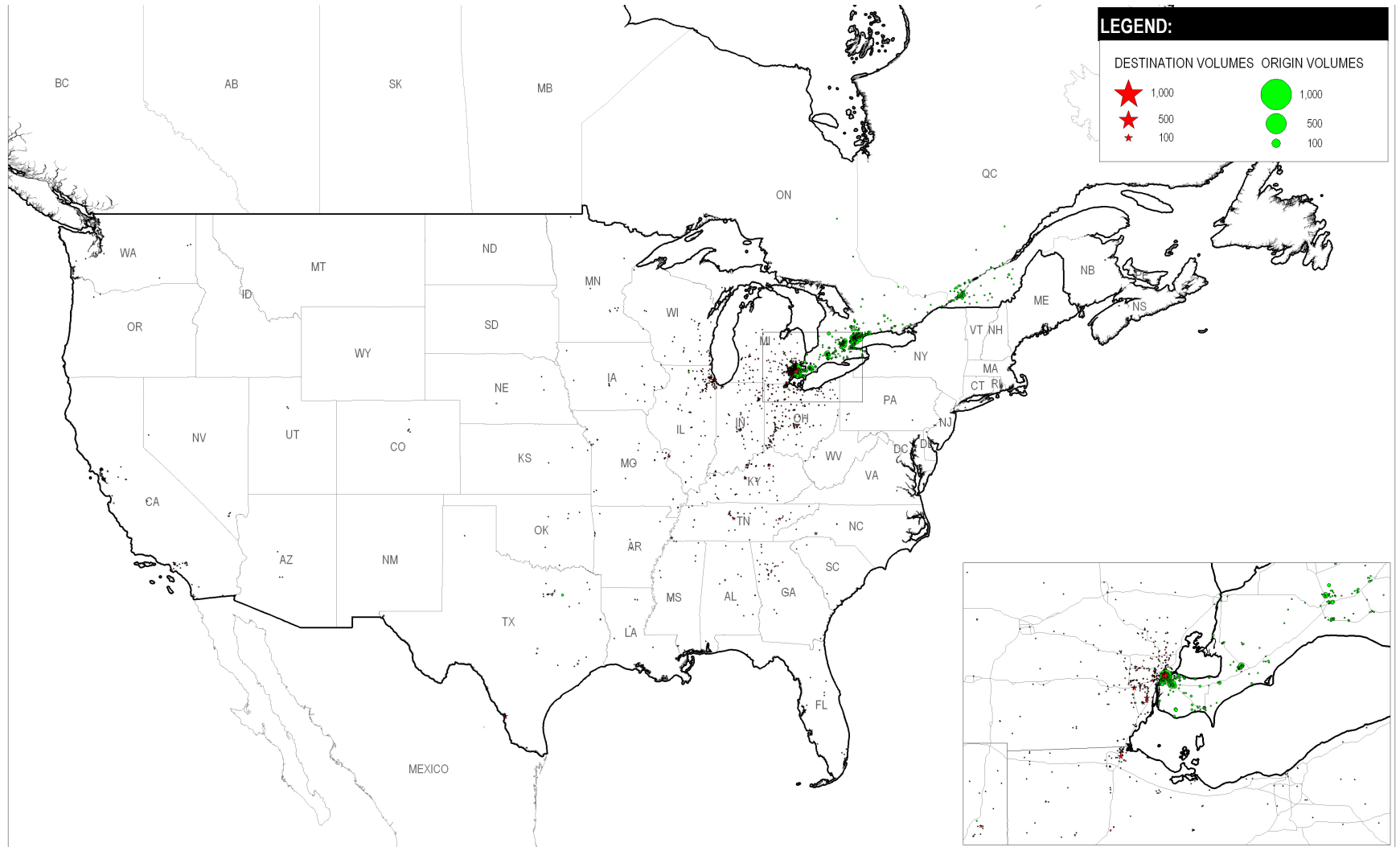


Exhibit 5-4 (Cont.): Weekday Commercial Vehicle Trip Origins & Destinations, Fall 2008

C. Blue Water Bridge, To Canada

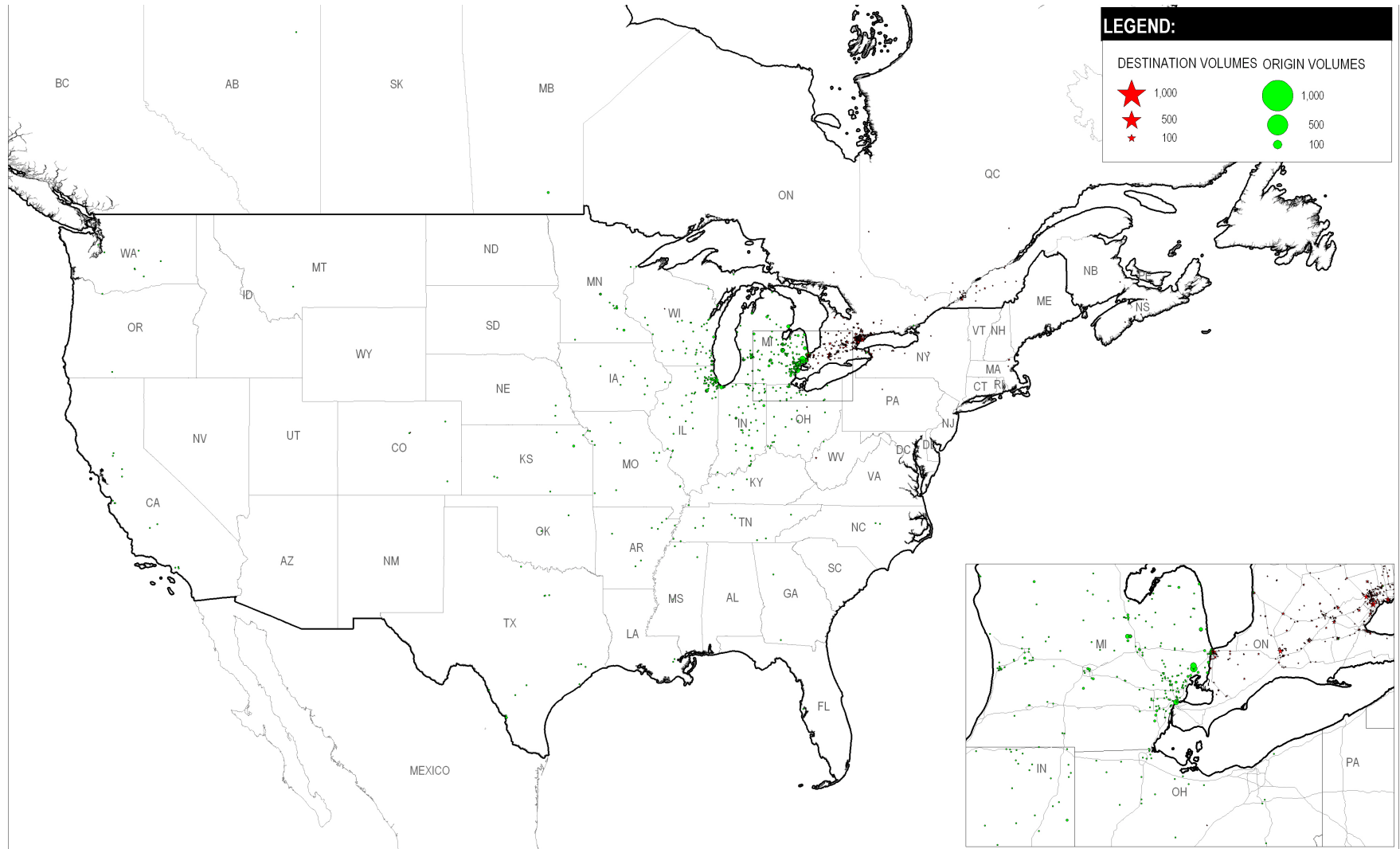


Exhibit 5-4 (Cont.): Weekday Commercial Vehicle Trip Origins & Destinations, Fall 2008

D. Blue Water Bridge, To US

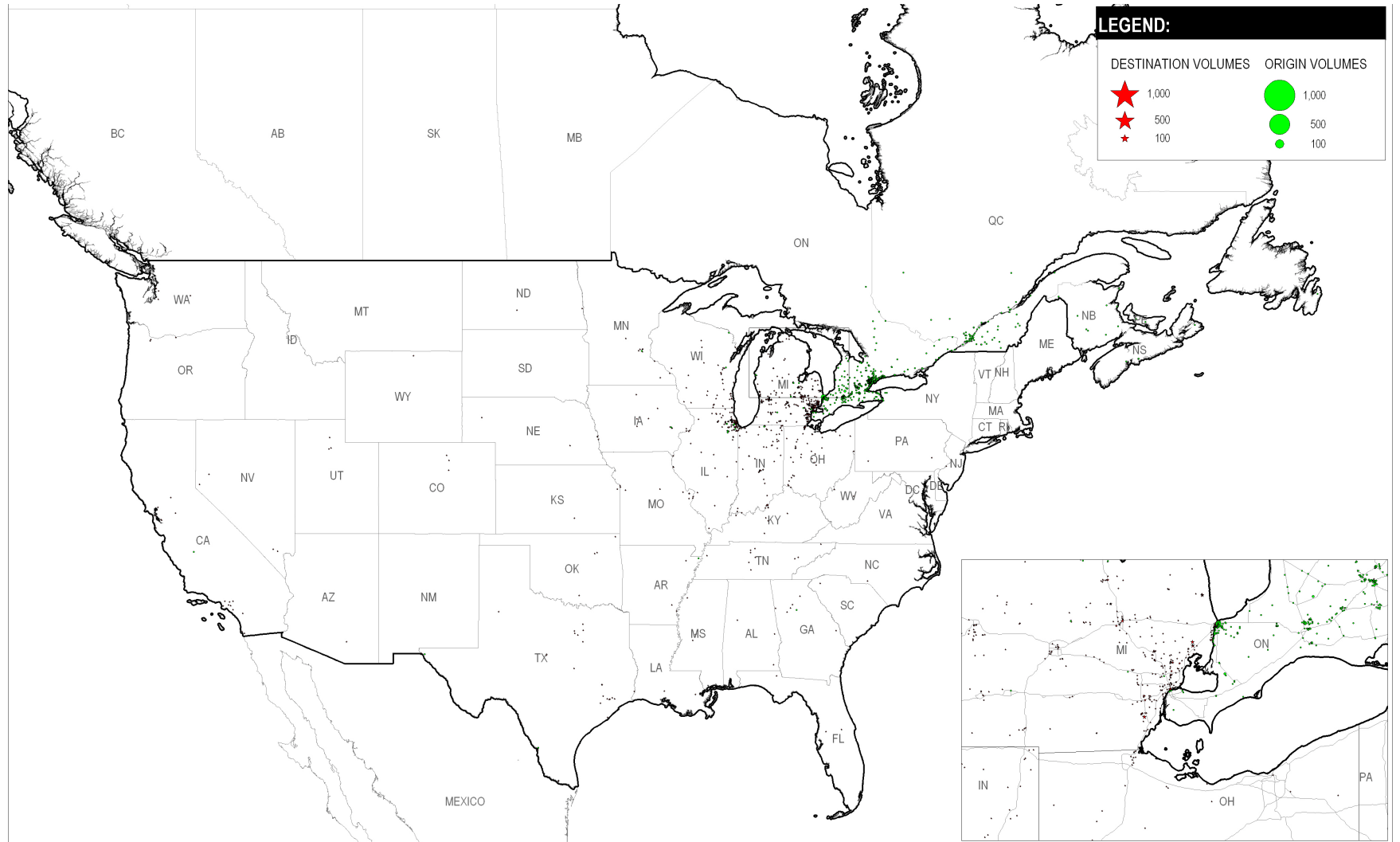


Exhibit 5-5: Weekday Commercial Vehicle Travel Origin and Destination Matrix, Fall 2008

A. Ambassador Bridge, Trips

ORIGIN	DESTINATION										
	1	2	3	4	5	6	7	8	9	10	TOTAL
1 Detroit + NE Wayne						6	148	68		217	439
2 Rest of Wayne County						59	267	91		481	899
3 Port Huron/St. Clair County							8				8
4 Rest of SEMCOG						10	139	60		115	324
5 Rest of Michigan							140	41		170	351
6 Other USA/Mexico	3						535	192	8	3,013	3,752
7 Windsor	164	184	8	151	102	428			3		1,041
8 Rest of Essex County	66	97	3	70	63	286					584
9 Sarnia/Lambton County		4				22					26
10 Other Ontario/Canada	243	419		233	142	3,407					4,444
TOTAL	477	704	11	454	307	4,217	1,238	453	11	3,996	11,868

B. Ambassador Bridge, Proportion of Total Trips

ORIGIN	DESTINATION										
	1	2	3	4	5	6	7	8	9	10	TOTAL
1 Detroit + NE Wayne						0%	1%	1%		2%	4%
2 Rest of Wayne County						0%	2%	1%		4%	8%
3 Port Huron/St. Clair County							0%				0%
4 Rest of SEMCOG						0%	1%	1%		1%	3%
5 Rest of Michigan							1%	0%		1%	3%
6 Other USA/Mexico	0%						5%	2%	0%	25%	32%
7 Windsor	1%	2%	0%	1%	1%	4%			0%		9%
8 Rest of Essex County	1%	1%	0%	1%	1%	2%					5%
9 Sarnia/Lambton County		0%				0%					0%
10 Other Ontario/Canada	2%	4%		2%	1%	29%					37%
TOTAL	4%	6%	0%	4%	3%	36%	10%	4%	0%	34%	100%

Exhibit 5-5 (Cont.): Weekday Commercial Vehicle Travel Origin and Destination Matrix, Fall 2008

C. Blue Water Bridge, Trips

ORIGIN	DESTINATION										TOTAL
	1	2	3	4	5	6	7	8	9	10	
1 Detroit + NE Wayne						6	3		14	79	102
2 Rest of Wayne County						6			7	80	94
3 Port Huron/St. Clair County						17			27	126	170
4 Rest of SEMCOG						34			24	326	384
5 Rest of Michigan						77			70	518	666
6 Other USA/Mexico			2	3	2	25	4		117	1,340	1,493
7 Windsor						6					6
8 Rest of Essex County			3		2	2					7
9 Sarnia/Lambton County	28	18	35	18	78	79					254
10 Other Ontario/Canada	46	69	76	356	492	780			23		1,841
TOTAL	73	86	115	377	574	1,032	7	0	282	2,470	5,017

D. Blue Water Bridge, Proportion of Total Trips

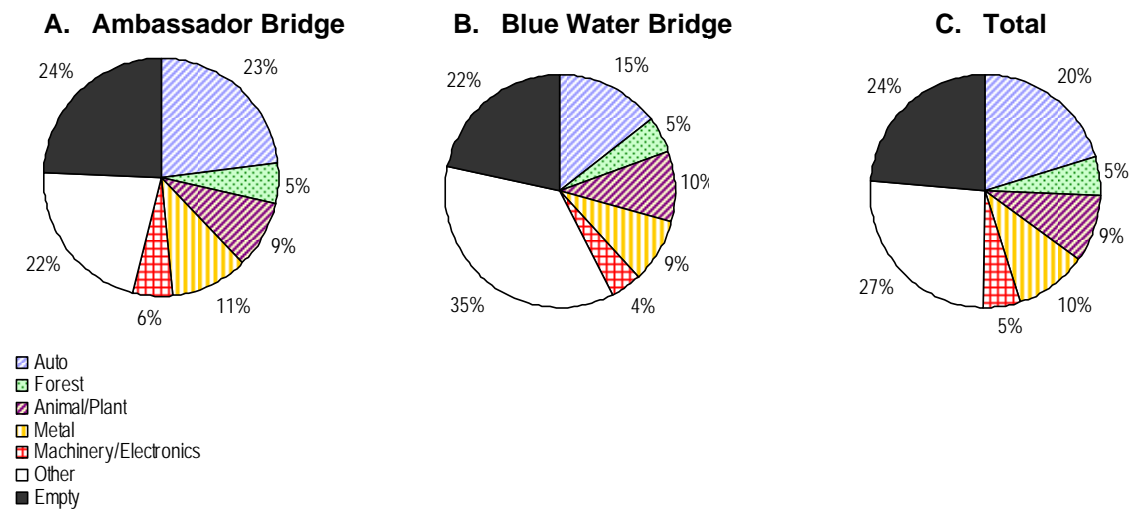
ORIGIN	DESTINATION										TOTAL
	1	2	3	4	5	6	7	8	9	10	
1 Detroit + NE Wayne						0%	0%		0%	2%	2%
2 Rest of Wayne County						0%			0%	2%	2%
3 Port Huron/St. Clair County						0%			1%	3%	3%
4 Rest of SEMCOG						1%			0%	7%	8%
5 Rest of Michigan						2%			1%	10%	13%
6 Other USA/Mexico			0%	0%	0%	0%	0%		2%	27%	30%
7 Windsor						0%					0%
8 Rest of Essex County			0%		0%	0%					0%
9 Sarnia/Lambton County	1%	0%	1%	0%	2%	2%					5%
10 Other Ontario/Canada	1%	1%	2%	7%	10%	16%			0%		37%
TOTAL	1%	2%	2%	8%	11%	21%	0%	0%	6%	49%	100%

5.4.2 COMMODITY TYPES

A summary of the distribution of weekday commercial vehicle volumes by commodity type and crossing is illustrated in Exhibit 5-6. The most common commodity type by volume of commercial vehicles is related to the auto industry with about 3,500 vehicles daily, or 20% of all trips. In addition to these, a percentage of the almost 1,700 vehicles daily carrying metal would be directly related to the auto industry. The Ambassador Bridge carries almost 80% of the 3,500 daily auto industry-related commercial vehicle trips among the three crossings.

Almost one-quarter of trucks are not carrying any freight at all when crossing the border. The proportion of empty movements is much higher than typical non-cross border movements given US Customs Service, US Immigration and Naturalization Service and Citizenship and Immigration Canada laws on cabotage, which restrict non-citizen truck drivers from picking up and hauling goods. Hence, for example, a Canadian truck driver may cross the border and deliver in the US, but might not be allowed to carry back cargo from the US to Canada.

Exhibit 5-6: Distribution of Commercial Vehicle Volumes by Commodity Type, Fall 2008



Source: 2006 Transport Canada NRS

A more detailed version of the data is tabulated in Exhibit 5-7, which shows truck commodity flows by direction of crossing and origin-destination pattern. Flows by direction are fairly balanced by direction, with the exceptions of the auto and forest industries and empty trucks. While passenger cars tend to return using the same crossing, trucks are somewhat more likely to use a different one as they based on the routings provided by their logistics groups.

The travel patterns of commercial vehicles also vary according to the commodity carried. For instance, 83% of forest product trips (generally originating in Québec) are long-distance only while 54% of auto trips (generally originating in Detroit-Windsor) are. Not surprisingly, most empty trucks are travelling shorter distances, with 19% of their total as local-only trips, or about half of the total local-only trips.

Exhibit 5-7: Commercial Vehicle Volumes by Commodity Type, Fall 2008

Crossing	Commodity Type							
	Auto	Forest	Animal/ Plant	Metal	Machinery/ Electronics	Other	Empty	Total
Weekday Volumes								
Ambassador Bridge								
Into Canada	1,571	178	429	582	324	1,221	1,459	5,764
Into US	1,164	466	670	670	333	1,355	1,443	6,101
TOTAL	2,735	644	1,098	1,253	657	2,576	2,902	11,865
Percent	23%	5%	9%	11%	6%	22%	24%	100%
Blue Water Bridge								
Into Canada	406	125	348	252	157	931	678	2,897
Into US	322	119	145	185	65	861	413	2,111
TOTAL	728	244	493	437	222	1,792	1,091	5,008
Percent	15%	5%	10%	9%	4%	36%	22%	100%
TOTAL								
Into Canada	1,976	303	776	835	481	2,152	2,137	8,661
Into US	1,486	585	815	855	398	2,216	1,857	8,212
TOTAL	3,463	888	1,591	1,690	879	4,368	3,994	16,872
Percent	21%	5%	9%	10%	5%	26%	24%	100%
Origin-Destination Type								
Weekday Volumes								
Local Only	296	53	22	107	59	217	776	1,530
US/Long-distance	708	96	130	385	101	782	985	3,186
Canada/Long-distance	573	114	31	159	38	290	599	1,805
Long-Distance Only	1,886	1,328	705	1,039	680	3,079	1,633	10,350
TOTAL	3,463	1,591	888	1,690	879	4,368	3,994	16,872
Percentages By Commodity								
Local Only	9%	3%	3%	6%	7%	5%	19%	9%
US/Long-distance	20%	6%	15%	23%	12%	18%	25%	19%
Canada/Long-distance	17%	7%	3%	9%	4%	7%	15%	11%
Long-Distance Only	54%	83%	79%	62%	77%	70%	41%	61%
TOTAL	100%	100%	100%	100%	100%	100%	100%	100%
Percentages By Origin-Destination Type								
Local Only	19%	3%	1%	7%	4%	14%	51%	100%
US/Long-distance	22%	3%	4%	12%	3%	25%	31%	100%
Canada/Long-distance	32%	6%	2%	9%	2%	16%	33%	100%
Long-Distance Only	18%	13%	7%	10%	7%	30%	16%	100%
TOTAL	21%	9%	5%	10%	5%	26%	24%	100%

Source: 2006 Transport Canada NRS

5.4.3 VEHICLE CONFIGURATIONS

Border crossings generally carry a higher proportion of larger trucks than would be seen on a typical highway. The proportions of weekday vehicle configurations at each of the border crossings is shown in Exhibit 5-8. At the Ambassador and Blue Water Bridges, 90% of commercial vehicles are tractors with one trailer and 95% of commercial vehicles have at least one trailer.

Exhibit 5-8: Commercial Vehicle Configurations, Fall 2006

Configuration	Crossing		Total
	Ambassador Bridge	Blue Water Bridge	
Tractor & 1 Trailer	91.9%	86.6%	90.4%
Tractor & 2 Trailers	2.9%	8.5%	4.5%
Straight Truck	4.0%	3.9%	4.0%
Straight Truck & Trailer	0.6%	0.2%	0.5%
Tractor Only	0.5%	0.7%	0.6%
Total	100%	100%	100%

Source: 2006 Transport Canada NRS

5.5 2000 to 2008 Trends

The 2006 NRS is the follow-up survey to the one conducted in 2000. The 2006 data have been expanded to 2008 truck traffic volumes. The following is a comparison of the two to investigate the trends in travel characteristics between 2000 and 2008, assuming that the 2006 characteristics have held to 2008.

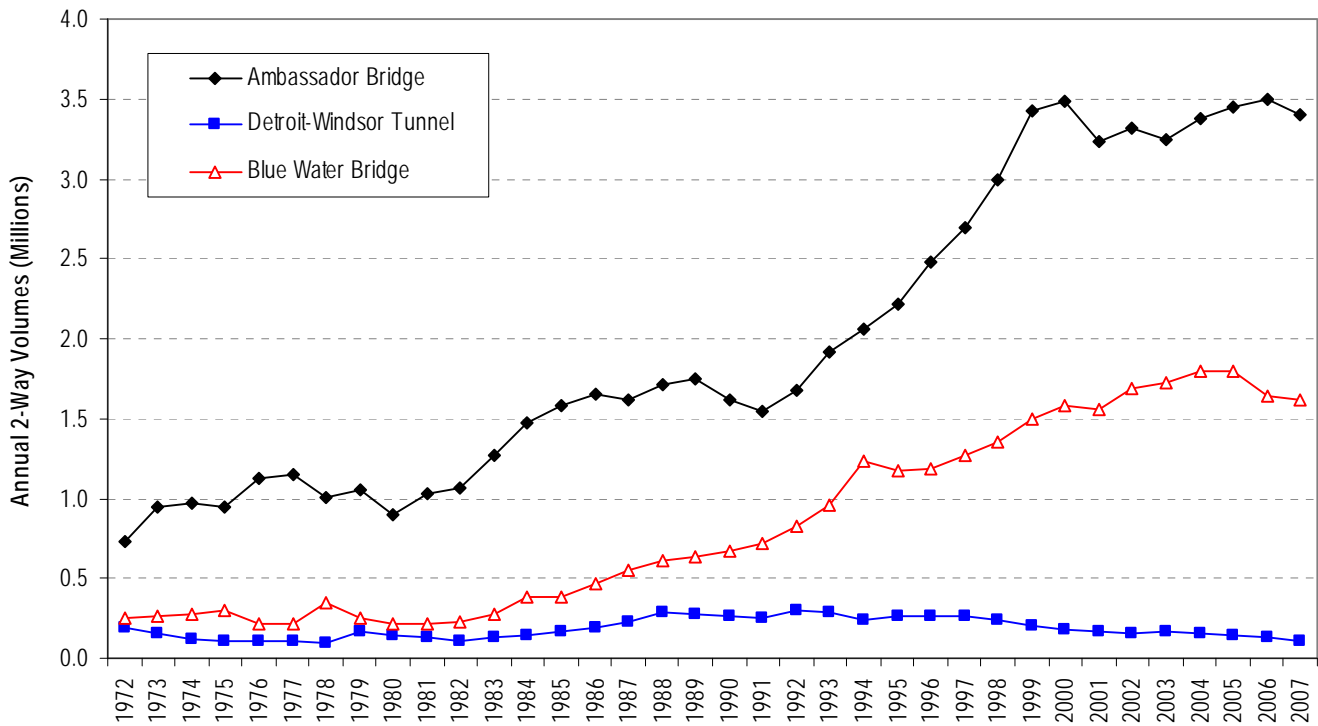
Many of the socio-economically significant events that have occurred since 2000 that have greatly affected passenger car travel have had impacts on truck traffic as well, namely the tech-bubble burst of 2000, 9/11 and the Iraq War, and, much more recently, the increase in value of the Canadian dollar and the price of gasoline.

One additional factor affecting commercial vehicles and not cars in the study area is the significant decline in sales and workforce experienced by the “Big Three” auto manufacturers. Some highlights include:

- Between 1998 and 2008, the combined North American market share of the Big Three fell from 70% to 47%;
- 2006 was one of the worst years in the Big Three’s history, with General Motors, Ford and DaimlerChrysler reporting decreases in sales of 8.7%, 8% and 7%, respectively, over 2005; and
- So far in 2008, General Motors, largest of the Big Three, has closed a transmission plant in Windsor (affecting 1,400 workers) and a truck plant in Oshawa, Ontario (affecting 2,500 workers). The company lost \$39 billion in 2007.

Exhibit 5-9 shows that, up to 2007, annual truck volumes at the two bridge crossings did not experience the enormous declines that passenger cars did, with 2007 volumes about the same as 2000 volumes. The tunnel, which typically carries less than 5% of the total truck volume, did experience a 44% drop in volume. Very recently, however, volumes on all three crossings appear to have declined, with January 2008 volumes down 22%, 3% and 11% at the Ambassador Bridge, Detroit-Windsor Tunnel and Blue Water Bridge, respectively, relative to January of 2007 (also shown in Section 5.4). As such, the socio-economic events described above have served more to restrain the growth in truck traffic rather than dampen it.

Exhibit 5-9: Annual Commercial Vehicle Traffic Volumes, 1972 to 2007



Exhibits 5-10 and 5-11 present the 2000 to 2008 trends in travel patterns and commodity types for each of the study crossings. In general, the trends are consistent with the set of events described above, with auto-industry truck traffic experiencing significant decreases, along with forest-industry traffic. With auto-industry traffic representing about four times the traffic volume of the forest industry, both have decreased by over 40% at both crossings since 2000, corresponding to loses in the share of total traffic of fourteen and four points, respectively. The difference has been made up with significant increases in empty truck movements, presumably as a result of the turmoil in the auto industry leading to inefficiencies in its transportation network and logistics. In terms of the travel patterns, given the local ties within the auto industry on both side of the border in Detroit-Windsor, local-to-local travel has declined the most, losing about four points of the total share of traffic.

Exhibit 5-10: Weekday Commercial Vehicle Travel Pattern Trends, 2000 to 2008

Crossing	Trip Interchange	2000		2008		2000 to 2008 Change		
		Trips	Prop.	Trips	Prop.	Trips	%	Prop.
Ambassador Bridge	Local to Local	2,580	21%	1,680	14%	-900	-35%	-7%
	Local (US) to/from Long Distance	1,870	16%	1,640	14%	-230	-12%	-2%
	Local (Canada) to/from Long Distance	2,030	17%	2,390	20%	360	18%	3%
	Long Distance to Long Distance	5,560	46%	6,160	52%	600	11%	6%
	<i>Total</i>	<i>12,040</i>	<i>100%</i>	<i>11,870</i>	<i>100%</i>	<i>-170</i>	<i>-1%</i>	<i>0%</i>
Blue Water Bridge	Local to Local	50	1%	100	2%	50	100%	1%
	Local (US) to/from Long Distance	1,230	21%	880	17%	-350	-28%	-4%
	Local (Canada) to/from Long Distance	210	4%	440	9%	230	110%	5%
	Long Distance to Long Distance	4,250	74%	3,610	72%	-640	-15%	-2%
	<i>Total</i>	<i>5,740</i>	<i>100%</i>	<i>5,030</i>	<i>100%</i>	<i>-710</i>	<i>-12%</i>	<i>0%</i>
Total	Local to Local	2,630	15%	1,780	11%	-850	-32%	-4%
	Local (US) to/from Long Distance	3,100	17%	2,520	15%	-580	-19%	-3%
	Local (Canada) to/from Long Distance	2,240	13%	2,830	17%	590	26%	4%
	Long Distance to Long Distance	9,810	55%	9,770	58%	-40	0%	3%
	<i>Total</i>	<i>17,780</i>	<i>100%</i>	<i>16,900</i>	<i>100%</i>	<i>-880</i>	<i>-5%</i>	<i>0%</i>

Note: For the Ambassador Bridge, a "local" trip end refers to Essex and Kent Counties in Ontario, and the SEMCOG area excluding St. Clair County in Michigan. For the Blue Water Bridge, a "local" trip end refers to Lambton County in Ontario, and St. Clair, Macomb, Oakland and Livingston Counties in Michigan.

Exhibit 5-11: Weekday Commercial Vehicle Commodity Type Trends, 2000 to 2008

Crossing	Commodity Type	2000		2008		2000 to 2008 Change		
		Trips	Prop.	Trips	Prop.	Trips	%	Prop.
Ambassador Bridge	Auto	4,224	35%	2,735	23%	-1,489	-35%	-12%
	Forest	1,082	9%	644	5%	-438	-41%	-4%
	Animal/Plant	1,129	9%	1,098	9%	-31	-3%	0%
	Metal	836	7%	1,253	11%	417	50%	4%
	Machinery/Electronics	547	5%	657	6%	110	20%	1%
	Other	2,510	21%	2,576	22%	66	3%	1%
	Empty	1,716	14%	2,902	24%	1,186	69%	10%
	<i>Total</i>	<i>12,044</i>	<i>100%</i>	<i>11,865</i>	<i>100%</i>	<i>-179</i>	<i>-1%</i>	<i>0%</i>
Blue Water Bridge	Auto	1,844	32%	728	15%	-1,116	-61%	-18%
	Forest	505	9%	244	5%	-261	-52%	-4%
	Animal/Plant	432	8%	493	10%	61	14%	2%
	Metal	445	8%	437	9%	-8	-2%	1%
	Machinery/Electronics	294	5%	222	4%	-72	-24%	-1%
	Other	1,627	28%	1,792	36%	165	10%	7%
	Empty	596	10%	1,091	22%	495	83%	11%
	<i>Total</i>	<i>5,742</i>	<i>100%</i>	<i>5,008</i>	<i>100%</i>	<i>-734</i>	<i>-13%</i>	<i>0%</i>
Total	Auto	6,068	34%	3,463	21%	-2,605	-43%	-14%
	Forest	1,586	9%	888	5%	-699	-44%	-4%
	Animal/Plant	1,561	9%	1,591	9%	30	2%	1%
	Metal	1,281	7%	1,690	10%	409	32%	3%
	Machinery/Electronics	841	5%	879	5%	38	5%	0%
	Other	4,136	23%	4,368	26%	231	6%	3%
	Empty	2,312	13%	3,994	24%	1,682	73%	11%
	<i>Total</i>	<i>17,785</i>	<i>100%</i>	<i>16,872</i>	<i>100%</i>	<i>-913</i>	<i>-5%</i>	<i>0%</i>

6. SUMMARY

The report describes the design and conduct, data processing as well as summary results for a passenger car origin-destination travel survey undertaken in April 2008 at the Ambassador Bridge, Detroit-Windsor Tunnel and Blue Water Bridge, capturing a sample of international traffic. It also describes the processing and summary results of preliminary 2006 National Roadside Survey data that represent origin-destination travel characteristics for commercial vehicles crossing the border at the Ambassador Bridge and Blue Water Bridge. Both of these surveys represent updates of similar efforts conducted in 2000 and, as such, can be used to determine travel characteristics trends since that time, spanning a period of tumultuous socio-economic activity and extreme events both across the continent and in the study area.

The objective of the passenger car survey was to obtain a valid ten percent sample of the average weekday traffic at each crossing. After processing of the data collected, 3,972 valid observations were obtained, representing 11.5% of the total average weekday traffic of about 34,500 cars. The addition of revealed preference data from the stated preference survey conducted in parallel to this survey as well as US-bound trip information collected at the Ambassador Bridge and Detroit-Windsor Tunnel locations resulted in 3,093 more observations, for a total of 7,065 and a 20.5% sample.

Analysis of these data in conjunction with traffic volume counts show that car volumes have decreased significantly since 2000, with annual 2007 volumes down by 35%, 48% and 22% since 2000 at the Ambassador Bridge, Detroit-Windsor Tunnel and Blue Water Bridge, respectively. A number of significant socio-economic events have occurred since 2000 that explain such decreases, including the opening of casinos in Detroit, the "tech-bubble burst" in 2000, 9/11 and the Iraq War, the SARS epidemic in Toronto, the increase in value of the Canadian dollar, and the increase in the price of gasoline. These events have had a large impact on discretionary, non-work/business travel. Across the two Detroit-Windsor crossings, work-related travel has decreased by 16% while total travel has decreased by almost half. In terms of the travel patterns, as work travel is more stable and repetitive, the changes in this trip interchange have been somewhat less than the others, gaining six points of the share of total traffic.

The NRS commercial vehicle data and volume counts tell a somewhat different story, with volumes remaining about constant since 2000. The socio-economic events noted above, in conjunction with the turmoil within the auto industry, have served more to restrain the growth in truck traffic rather than dampen it and reflects international trade between Canada and the US. Auto-industry truck traffic has experienced significant decreases, along with forest-industry traffic. With auto-industry traffic representing about four times the traffic volume of the forest industry, both have decreased by over 40% at both crossings since 2000, corresponding to losses in the share of total traffic of fourteen and four points, respectively. The difference has been made up with significant increases in empty truck movements, given the early stages of a downturn in the economy at the time. This presumably would correct over time to more typical productivity levels and thus use of excess capacity could be masking some real growth in the amount of goods carried across the gateway with inefficiencies in its transportation network and logistics. In terms of the travel patterns, given the local ties within the auto industry on both side of the border in Detroit-Windsor, local-to-local travel has declined the most, losing about four points of the total share of traffic.

THIS PAGE INTENTIONALLY LEFT BLANK

APPENDIX A

OCCUPATIONAL HEALTH AND SAFETY AND TRAFFIC CONTROL PLAN

THIS PAGE INTENTIONALLY LEFT BLANK

Transport Canada

**TRAFFIC AND REVENUE FORECASTER STUDY FOR THE
WINDSOR GATEWAY**

**TRAVEL SURVEY OCCUPATIONAL HEALTH AND SAFETY
AND TRAFFIC CONTROL PLAN**

REPORT

MARCH 2008



THIS PAGE INTENTIONALLY LEFT BLANK

TABLE OF CONTENTS

1. PROJECT DETAILS.....	1
1.1 Company Contact Information.....	1
1.2 IBI Group Project Staff.....	1
2. OHS PLAN	2
2.1 Occupational Health and Safety Policy.....	2
2.2 Potential Hazard Identification and Safety Provisions.....	2
2.3 Information and Instructions.....	4
2.4 Response Procedures	4
2.5 Emergency Contact Numbers	5
3. TRAFFIC CONTROL PLAN.....	6

LIST OF EXHIBITS

Exhibit 2-1: Potential Hazards	3
Exhibit 2-2: Response Procedures	5
Exhibit 2-3: Emergency Contact Numbers.....	5
Exhibit 3-1: Detroit-Windsor Tunnel Survey Setup	7
Exhibit 3-2: Blue Water Bridge Survey Setup	9

LIST OF APPENDICES

APPENDIX A – IBI Group Health and Safety Policy

1. PROJECT DETAILS

The project requires data collection of travel origin-destination traffic flow patterns at three international crossings including the Ambassador Bridge, Detroit-Windsor Tunnel and Blue Water Bridge. Data collection activities involve a road-side survey to interview a sample of motorists travelling through the international crossings. In order to conduct the interviews, passenger vehicles need to be intercepted during their trip and asked to participate in a survey. The approach requires strict safety measures to be implemented during the survey work, providing a safe environment for workers and motorists, and reducing the potential for accidents to a minimum. Also, manual traffic counts will be conducted on the same days and locations as the surveys to count and classify all vehicles crossing the border. The following data collection activities require compliance with the Occupational Health and Safety Act (OHSA).

ACTIVITY	COMPLETED BY
Data Collection Training	Presentation of the field manual and OHS policies to field staff. IBI Group – Len Eberhard, Dewan Karim, Tina Noble, Mauricio Alamillo
Origin-destination surveys and traffic counts	IBI Group – Len Eberhard, Dewan Karim, Mauricio Alamillo

To comply with the OHS Act, IBI Group commits to the development of the project-specific Health and Safety Plan. The Project Manager shall review the safety procedures to be observed during the fieldwork to ensure a safe workplace and awareness of workplace hazards that may be encountered in the field. The Project Manager will ensure that the project specific Health and Safety Plan is fully developed prior to initiation of any project-related field activities.

1.1 Company Contact Information

IBI Group
 230 Richmond St. West, 5th Floor
 Toronto, Ontario
 M5V 1V6

Tel: 416-596-1930
 Fax: 416-596-0644

1.2 IBI Group Project Staff

Team Member	Role	Phone	Email
Bruce Mori	Project Manager	(416) 596-1930	bmori@ibigroup.com
Mauricio Alamillo	Transportation Engineer	(416) 596-1930	mauricio.alamillo@ibigroup.com
Len Eberhard	Transportation Engineer	(416) 596-1930	leberhard@ibigroup.com
Dewan Karim	Transportation Engineer	(416) 596-1930	dewan.karim@ibigroup.com

2. OHS PLAN

2.1 Occupational Health and Safety Policy

IBI Group will take every precaution reasonable in the circumstances for the protection of worker health and safety, as required under the OHSA. IBI Group has a formal Occupational Health and Safety Policy in place as required by the OHSA (refer to Appendix A). With respect to the services being offered in this assignment, IBI Group acknowledges the responsibility to:

- Fulfil all of the obligations under the OHSA and ensure that all work is carried out in accordance with the OHSA and its regulations;
- Ensure that adequate and competent supervision is provide as per the OHSA to protect the health and safety of workers; and
- Provide information and instruction to all employees to ensure they are informed of the hazards inherent in the work and understand the procedures for minimizing the risk of injury or illness.

2.2 Potential Hazard Identification and Safety Provisions

The road-side survey involves the implementation of a survey station to intercept motorists, strategically located at the access/exit roads of each international facility under study. The survey station allows channelizing traffic into survey lanes and stoppage of all vehicles in a safe manner before conducting the interview. Survey stations are comprised of different sections: advance warning area, approach area, buffer area, work area, and a termination area.

Data collection requires a very strict planning and supervision of the activities in order to minimize the probability of an incident or collision. Planning activities will require preliminary site visits to each facility to identify proper locations that will satisfy maximum safety. Every survey station is planned through a specific traffic control plan, containing a layout to visualize the staff and equipment setup (i.e., traffic delineators, signage, staff positions, etc.).

The traffic control plan includes digital pictures and sketch layouts to ensure the understanding of safety measures. In field, each survey station will be implemented with sufficient traffic delineators and proper signage to conduct the survey in safe manner in accordance to Ontario's regulation codes.

Staff are composed of a mix of workers performing different activities: surveyors will conduct the interviews, traffic control persons will direct traffic and stop vehicles using adequate protection and signage, quality control staff will archive the surveys collected on field, and buffer staff will cover any staff positions in case of lunch breaks and non-attendances.

Supervisors will be present at all times to coordinate each survey station and staff activities, reinforcing the survey safety measures, and implementing the traffic control plan. Off-duty police officers will be supervising the general security of the survey station and directing traffic according to the traffic control plan during the survey. All staff on field will be provided with safety equipment including safety boots, vests, and hard-hats as required by the OHSA. As the survey period will be carried out under dusk and night times, staff will wear reflective wrist and leg bands, and carry photo identification. Also, police vehicles with roof-mounted lights will be located within a safe distance upstream the survey stations, warning motorists to reduce vehicle speeds before entering the survey area.

TRAFFIC AND REVENUE FORECASTER STUDY FOR THE WINDSOR GATEWAY
 TRAVEL SURVEY OHS AND TRAFFIC CONTROL PLAN

A comprehensive training of all staff will address conducting the data collection tasks in a safe and effective manner, emphasizing compliance with Ontario traffic laws and the safe operation of motor vehicles. Workers are not to smoke in the work sites or vehicles while undertaking their work duties. All workers operating a motor vehicle are to possess a valid Ontario driver's licence.

Exhibit 2-1 provides a list of potential hazards that may be encountered during the course of the data collection activities. For each hazard, the appropriate safety measure(s) is provided and will be communicated to all field personnel during data collection training.

Exhibit 2-1: Potential Hazards

Potential Hazard	Measures
General Measures For All Hazards	<ul style="list-style-type: none"> • Ensure field staff are provided with a copy of this project-specific Travel Survey OHS and Traffic Control Plan • Ensure workers are provided with and understand the surveyor training. • Minimize potential roadway hazards before establishing the survey location. • After each day potential safety issues will be forwarded to the IBI Supervisor to determine potential mitigating measures. • Ensure that worker is familiar with right to refusal or unsafe work.
Erratic Vehicle or Harassment by Other Motorists	<ul style="list-style-type: none"> • Field staff to physically remove themselves from situation including discontinuing survey under extreme conditions.
Survey Vehicle Parked in Right-of-Way	<ul style="list-style-type: none"> • Review survey locations and establish approved temporary conditions set-up prior to surveys. • Ensure temporary conditions set-up is in agreement with approved plan. • Worker to immediately identify any safety concerns relating to vehicle location to IBI Group supervisors.
Concern Relating to Any Persons Actions or Loitering Individuals	<ul style="list-style-type: none"> • Do not engage individual. • Worker to physically remove themselves from situation and report hazard to IBI Group supervisor or Police. The latter contact should only be made in Emergency situations. • Carry photo identification.
Vehicle Breakdown/Failure	<ul style="list-style-type: none"> • Contact IBI Supervisor in the event of a vehicle failure. • IBI Supervisor will inspect vehicles prior to deployment and field staff will perform regular maintenance checks (e.g. oil levels, tire pressure, headlights, signal lights, etc.).
Vehicle Collision	<ul style="list-style-type: none"> • Contact emergency services. • Contact IBI Group Supervisor who will notify IBI Group Project Manager. • Preserved the scene of the accident. • Await arrival of emergency services.
Visibility/Environmental Conditions	<ul style="list-style-type: none"> • Do not work in inclement weather when visibility is reduced or slippery conditions exist. • Advise workers to dress appropriately for weather conditions including sunglasses.

TRAFFIC AND REVENUE FORECASTER STUDY FOR THE WINDSOR GATEWAY
TRAVEL SURVEY OHS AND TRAFFIC CONTROL PLAN

Potential Hazard	Measures
Harmful Insects/West-Nile Virus	<ul style="list-style-type: none"> • Apply deet-based insect repellent
Sun-Exposure	<ul style="list-style-type: none"> • Stay in shade as much as possible • Apply sunscreen product
Emergencies	<ul style="list-style-type: none"> • Field staff, IBI Group Supervisor provided with cell phones. • Field staff provided with quick reference emergency contact numbers for the area (Refer to Section 2.5). • Allow passage of emergency vehicles as under normal driving conditions.
Minor Injuries	<ul style="list-style-type: none"> • Maintain first aid kit in survey vehicles. • Instruct field staff of proper use of first aid kit. • Supervisors with basic First Aid training.
Serious or Critical Injuries	<ul style="list-style-type: none"> • Contact Emergency Services. • Notify IBI Group Supervisor. • Notify Ministry of Labour.

2.3 Information and Instructions

IBI Group will ensure all reasonable precautions in equipping field staff with information to protect their personal safety. Field staff will receive training prior to the commencement of data collection activities. IBI Group will instruct field staff of their responsibilities to the project while emphasizing their responsibilities to the survey station and roadway safety. All workers will be educated on the potential hazards and the corresponding safety measures as identified in Exhibit 2-1. The traffic control staff will be selected and trained to comply with the responsibilities described as per the Ontario Traffic Manual (OTM) Book 7 Section 4.4. Participation in the training session is considered a requisite to be accepted in the survey station.

Supervisors will be provided with a cell phone and a list of contacts for key individuals and emergency services. Competent supervision will be appointed to ensure employee compliance within the safety regulations during all data collection activities.

In the event that staff do not comply with the traffic management plan, traffic laws or safety regulations, they will be removed from the project.

2.4 Response Procedures

Exhibit 2-2 identifies the response procedures for addressing the safety concerns identified by MTO or the Ministry of Labour.

TRAFFIC AND REVENUE FORECASTER STUDY FOR THE WINDSOR GATEWAY
TRAVEL SURVEY OHS AND TRAFFIC CONTROL PLAN

Exhibit 2-2: Response Procedures

OHS VIOLATION	RESPONSE PROCEDURES
OHS Issues Identified by the Ministry	
MTO notified IBI, in writing, of a health and safety concern and the Ministry's expectations.	<ul style="list-style-type: none"> • IBI to correct the problem immediately. • IBI to notify MTO in writing that the issue has been correct and how it was corrected.
Managing Orders from the Ministry of Labour	
Ministry of Labour issued MOL Order to IBI	<ul style="list-style-type: none"> • IBI to notify MTO of the MOL orders/charges issued against IBI. • IBI to provide status reports to MOL and MTO related to the issued order/charges. • IBI to notify about rectifying the safety issue identified in the MOL order
Fulfilling MOL notification for critical injuries and fatalities	
Critical injuries or fatalities have occurred	<ul style="list-style-type: none"> • Fulfill MOL notification requirements as per OHS Act.
Notifying the Ministry of critical injuries/fatalities and MOL orders	
Critical injuries or fatalities have occurred	<ul style="list-style-type: none"> • IBI to review fatal/critical and personal injuries • IBI to report all personal injuries and motor vehicle accidents within 48 hours to MOL and to MTO within 5 days

2.5 Emergency Contact Numbers

Included in Exhibit 2-3 is a summary of emergency contact numbers to be provided to workers in the field.

Exhibit 2-3: Emergency Contact Numbers

Contact	Basis	Contact Number
Emergency Services	<ul style="list-style-type: none"> • Police • Fire • Ambulance 	911
Mauricio Alamillo IBI Group Field Supervisor	<ul style="list-style-type: none"> • Primary contact for notification of on-site issues 	Office: 416-596-1930 X430 Cellular: 416-435-95-82
Dewan Karim IBI Group Field Supervisor	<ul style="list-style-type: none"> • Primary contact for notification of on-site issues 	Office: 416-596-19-30 X406 Cellular: 416-435-35-64
Len Eberhard IBI Group Field Supervisor	<ul style="list-style-type: none"> • Primary contact for notification of on-site issues 	Office: 416-596-1930 X408
Bruce Mori IBI Group Project Manager	<ul style="list-style-type: none"> • Secondary contact for notification of on-site issues • Notification of workplace injury or incident 	Office: 416-596-1930 X429 Cellular: 416-709-1524

TRAFFIC AND REVENUE FORECASTER STUDY FOR THE WINDSOR GATEWAY
 TRAVEL SURVEY OHS AND TRAFFIC CONTROL PLAN

Contact	Basis	Contact Number
Ministry of Labour	<ul style="list-style-type: none"> Notification of workplace injury or incident 	Windsor Office: 4510 Rhodes Drive, Suite 610 Windsor ON N8W 5K5 Tel: 519-256-8277 or 1-800-265-5140 Fax: 519-258-1321

3. TRAFFIC CONTROL PLAN

The travel surveys and traffic counts will be performed in accordance with OTM Book 7. Due to the character of the locations where the survey will be conducted, no exact matches for the typical layouts described by the OTM Book 7 can be implemented. Nonetheless, an effort is made to imitate as much as possible the configuration TL-20A of the manual, designed for survey operations with visibility of 150 meters or less.

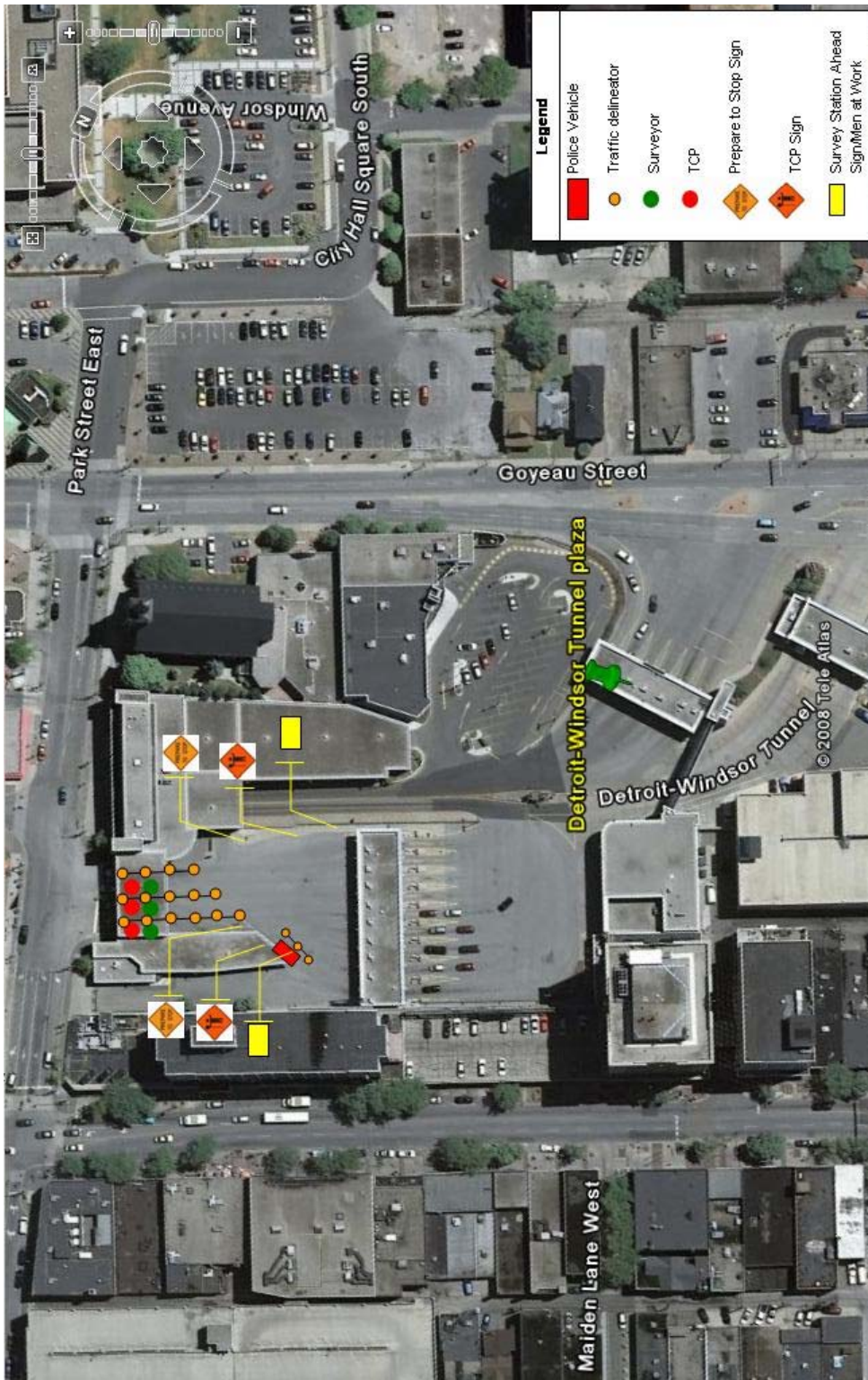
The traffic control plan includes the use of off-duty police officers and police vehicles with roof mounted lights to reduce the vehicle speeds upstream of the survey stations. The types of traffic delineators used to channelize traffic are TC-51B, TC-51C and TC-52. Traffic control signage includes Road Work sign TC-2A that will be supplemented by a Survey Station Ahead sign, Traffic Control Person Ahead sign TC-121b, and Traffic Control sign TC-22 (stop/slow paddle).

Exhibit 3-1 illustrates the survey station setup for the Detroit-Windsor Tunnel. Multiple surveyors and a traffic control person will be located at the end the survey lane. The traffic control person's task is to stop all motorists inside the survey lane using a stop/slow paddle before the surveyor approaches the vehicle and conducts the interview. The surveyor will ask the motorist to participate in a short survey lasting from 20 to 40 seconds. Also, an off-duty police officer will be located upstream of the survey station directing traffic and sending vehicles into the survey lanes.

Canada-bound traffic leaving the tunnel will be intercepted through one survey station located downstream of the customs plaza before the exit to Park Street. The survey station layout includes three survey lanes defined with traffic delineators. If congestion occurs and queues of vehicles spill back, the second and fourth lanes, numbered in the south-to-north direction, can be opened to allow free flow traffic. The first and third lanes have a curb where the staff can remain interviewing motorists under safe conditions. The police officer, parked upstream of the survey station, will alert motorists to reduce speeds before arrival to the survey stations and will maintain an even distribution of traffic into the stations. Warning signage includes a "Survey Work Ahead", "Traffic Control Person Ahead" and a "Prepare To Stop" signs located visibly for vehicles leaving the customs plaza. Transit Windsor buses leaving the customs plaza usually make a stop in the fourth lane, therefore, this lane will not be used for surveying purposes. Police officers will be instructed to help buses to get to the stop location. In case buses present difficulties to manoeuvre due to the traffic delineators these will be re-configured to provide more space.

TRAFFIC AND REVENUE FORECASTER STUDY FOR THE WINDSOR GATEWAY
TRAVEL SURVEY OHS AND TRAFFIC CONTROL PLAN

Exhibit 3-1: Detroit-Windsor Tunnel Survey Setup



TRAFFIC AND REVENUE FORECASTER STUDY FOR THE WINDSOR GATEWAY
TRAVEL SURVEY OHS AND TRAFFIC CONTROL PLAN

Exhibit 3-2 illustrates the survey station setup for the Blue Water Bridge. A surveyor and a traffic control person will be located at the end the survey lane. The traffic control person's task is to stop all motorists inside the survey lane using a stop/slow paddle before the surveyor approaches the vehicle and conducts the interview. The surveyor will ask the motorist to participate in a short survey lasting from 20 to 40 seconds. Also, an off-duty police officer will be located upstream of the survey station directing traffic and sending vehicles into the survey lanes.

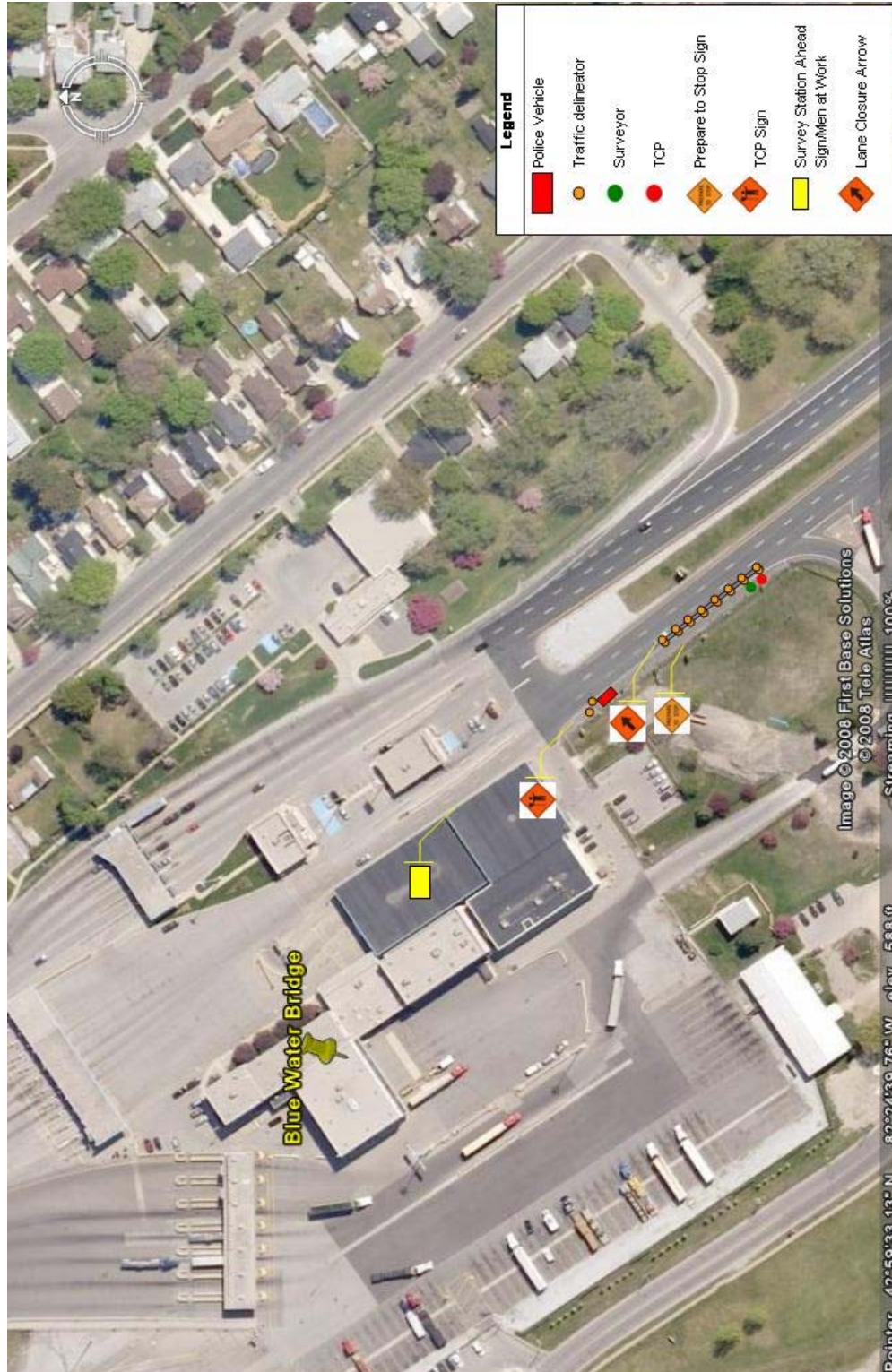
The Canada-bound traffic will be intercepted in one survey station located just after exiting the buildings area on the start segment of the Highway 402, however, still within the bridge property. One lane will be delineated with two stripes of traffic delineators to provide a buffer area for staff. If congestion occurs, survey lanes will be opened to avoid a spillback of vehicles. A police vehicle, parked upstream of the survey station, will alert motorists leaving the customs plaza to reduce speed. Warning signage includes a "Survey Station Ahead", "Traffic Control Person Ahead", "Lane Closure Arrow" and a "Prepare To Stop" signs located visibly for vehicles leaving the customs plaza.

The US-bound traffic will be surveyed using one survey station located downstream of the toll plaza. This survey station layout includes one lane delineated with traffic delineators located next to the free duty parking lot. An off-duty police officer and a police cruiser will be parked upstream of the survey station to direct vehicles into the survey lane. The police vehicle will alert motorists to reduce speed after leaving the toll plaza. Warning signage includes a "Survey Station Ahead", "Traffic Control Person Ahead", and a "Prepare To Stop" signs located before arrival to the toll plaza.

TRAFFIC AND REVENUE FORECASTER STUDY FOR THE WINDSOR GATEWAY
TRAVEL SURVEY OHS AND TRAFFIC CONTROL PLAN

Exhibit 3-2: Blue Water Bridge Survey Setup

A. Canada-Bound Traffic



TRAFFIC AND REVENUE FORECASTER STUDY FOR THE WINDSOR GATEWAY
TRAVEL SURVEY OHS AND TRAFFIC CONTROL PLAN

Exhibit 3-3 (Cont.): Blue Water Bridge Survey Setup

B. US-Bound Traffic



THIS PAGE INTENTIONALLY LEFT BLANK

APPENDIX A

IBI GROUP HEALTH & SAFETY POLICY

IBI Group Health & Safety Policy

The management team of IBI Group considers the health and safety of its employees to be of the utmost importance. Protection of staff from injury or occupational disease is a major continuing objective. IBI Group will make every effort to provide a safe, healthy work environment. All staff must be dedicated to the continuing objective of reducing risk of injury.

IBI Group, as an employer, is ultimately responsible for staff health and safety. All directors and project managers will be held accountable for the health and safety of workers under their supervision. Project managers are responsible to ensure that machinery and equipment are safe and that staff work in compliance with established safe work practices and procedures. Staff must receive adequate training in their specific work tasks to protect their health and safety.

Every staff member must protect his or her own health and safety by working in compliance with the law and with safe work practices and procedures established by IBI Group.

It is in the best interest of all parties to consider health and safety in every activity. A commitment to health and safety has, and will continue to form an integral part of IBI Group's organization.



Scott Stewart, Managing Director

APPENDIX B

SURVEY STAFF TRAINING PRESENTATION

Orientation Session: Field Study Training

Occupational Health and Safety
Plan and Traffic Control Plan
Origin–Destination Survey for
Windsor Gateway Project

March 2008

Overview

- General Instructions
- Terminating an O-D Survey
- Potential Hazards
- Supervision
- Traffic Control Plan
- Traffic Control Person
- Finish Up
- Question and Answers

March 2008



General Instructions

- Primary goal of the field surveys is to ensure:
 - **Safe operation of survey stations**
 - **Safety of the field staff**
- Each survey station is considered a work site
- While undertaking the survey, you are a representative of IBI and Transport Canada, so dress appropriately, be courteous to anyone who approaches you and carry photo identification

March 2008



General Instructions

- All staff must:
 - Read the Travel Survey Occupational Health and Safety Plan and Traffic Control Plan, March, 2008
 - “Sign-in” that they have attended this session
 - Ensure that a copy of the Travel Survey Occupational Health and Safety Plan and Traffic Control Plan is at your disposition
 - Be able to show the Ministry of Labour what traffic control plan they have set-up at the site

March 2008



General Instructions

- Each survey setup must have a first-aid kit
- Staff have the right to refuse unsafe work
- If you do not feel safe for any reason, remove yourself from the situation and contact one of the site supervisors

March 2008



General Instructions

- All staff is not allowed to smoke within the work zone
- If you wish to take a smoke break, you must leave the work zone and take a formal break from your surveying duties

March 2008



Terminating a Survey

- Surveys will not be started or continued through poor weather/visibility conditions
- Site supervisors will determine when to cancel or terminate a survey

March 2008



Potential Hazards & Safety Measures

- Field staff are provided with a copy of the H&S Plan and Traffic Control Plan
- Field staff should understand the training and job procedures
- Potential safety issues should be reported to IBI supervisors
- Field staff have the right to refuse unsafe work

March 2008



Potential Hazards & Safety Measures

- Moving Traffic:
 - Do not sit or stand on places close to moving traffic
 - Don't walk through traffic, look for an appropriate pedestrian crossing, wait for pedestrian sign to cross
 - Ensure that traffic conditions are safe before leaving the survey safe area
 - Surveyors must wear the protective equipment outlined in the **Travel Survey Occupational Health and Safety Plan and Traffic Control Plan** at all times

March 2008



Potential Hazards & Safety Measures

- Leave the survey setup if you encounter erratic motorist or are being harassed – contact supervisors

March 2008



Potential Hazards & Safety Measures

- Any serious injury or emergencies
- Safety measures
 - Contact emergency services - 911
 - Notify IBI Supervisor
 - Notify IBI Group project manager
 - Preserve the scene of incident
 - Prepare an incident report
- **ALL SURVEY STATIONS MUST HAVE CELL PHONE AND KEEP IT CHARGED**

March 2008



Potential Hazards & Safety Measures

- Beware of sun/heat exposure and harmful insects/West Nile Virus
- Use sunscreen and a deet-based product as required
- Bring sufficient water

March 2008



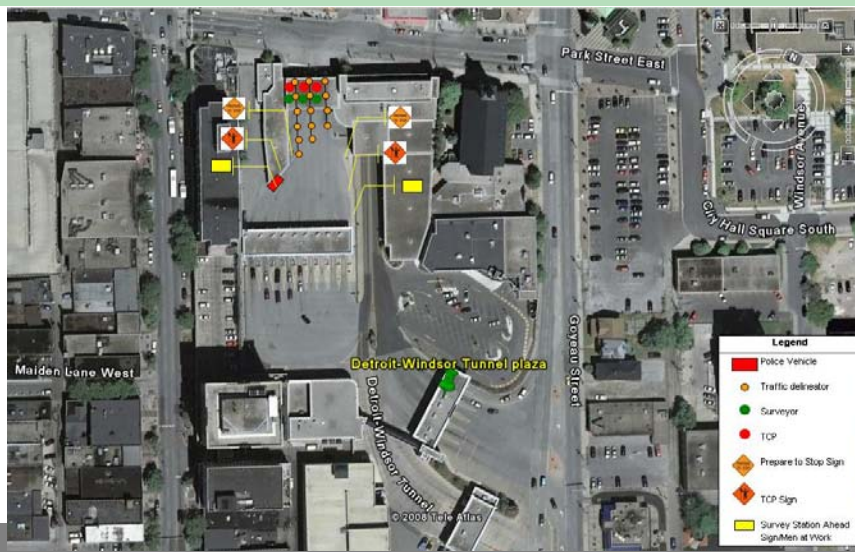
Supervision

- IBI Supervisors will be roaming from site to site to ensure the surveys are being completed properly and safely
- Their cell phone numbers are in the safety plan and field manual
- Ministry of Labour, Transport Canada, City of Windsor, DWT, BWB and police services have been notified of the study dates and locations.
- If they see anything that concerns them regarding safety or surveyor conduct, they have the right to stop the survey.

March 2008



Detroit-Windsor Tunnel Traffic Control Plan



Blue Water Bridge Traffic Control Plan



Blue Water Bridge Traffic Control Plan (cont'd)





Notes for Traffic Control Plan

- Survey stations will be delineated with traffic delineators (cones, drums) to channelize traffic safely
- Signage will be used to warn motorist about the survey station and the presence of traffic control person
- Police cruisers will be parked upstream of survey stations to warn motorists of survey station
- Off-duty police officers will direct traffic and secure the survey station area
- In case congestion spillbacks vehicles, survey lanes will be open to allow free flow traffic until congestion clears, survey lanes will be closed intermittently

March 2008



Any Questions



March 2008

APPENDIX C

SUPERZONE ORIGIN-DESTINATION TRIP MATRICES

APPENDIX **B**

STATED PREFERENCE SURVEY

This appendix contains the documentation of the stated preference survey results summary and model estimation as provided by the subconsultant, Resource Systems Group, Inc. for the Transport Canada 2008 comprehensive study.

THIS PAGE INTENTIONALLY LEFT BLANK



R | S | G INC.
RESOURCE SYSTEMS GROUP, INC.

Documentation for
**WINDSOR GATEWAY
STATED PREFERENCE STUDY**

Detroit, MI / Windsor, ON

Prepared by
Resource Systems Group, Inc.

Prepared for
Wilbur Smith Associates

November 2008



THIS PAGE INTENTIONALLY LEFT BLANK

EXECUTIVE SUMMARY

Transport Canada, in partnership with the Ontario Ministry of Transportation (MTO), the Michigan Department of Transportation (MDOT), and the Federal Highway Administration (FHWA) is currently evaluating a plan to build a new bridge that would span the Detroit River. Wilbur Smith Associates contracted Resource Systems Group, Inc. (RSG) to conduct an automobile and commercial vehicle stated preference study in the Detroit-Windsor area in support of their work for Transport Canada.

The purpose of the stated preference survey was to obtain detailed information to determine how sensitive travelers are to the tolling and travel-time changes resulting from the construction of the proposed bridge from Detroit, MI to Windsor, ON. The estimates of travelers' toll price sensitivities are used to support the development of the traffic and toll revenue forecasts for the proposed new crossing.

RSG developed and implemented a stated preference survey that gathered information from individuals who may use the proposed bridge. The survey collected revealed preference data on the characteristics of each respondent's most recent trip using one of the three current international crossings: the Ambassador Bridge, the Detroit-Windsor Tunnel, or the Blue Water Bridge. Stated preference experiments were used to estimate travelers' values of time and propensity to use the new proposed crossing under different travel time and toll cost conditions.

The data collection took place in the spring of 2008 throughout the Detroit-Windsor region. A multi-method sampling approach was used to collect data from automobile travelers, commercial vehicle drivers, and commercial vehicle routing decision makers, such as fleet dispatchers and managers. A total of 848 respondents completed the survey designed for automobile users, while 293 respondents completed the commercial vehicle survey and 122 respondents completed the commercial vehicle decision maker survey.

Discrete choice model estimation was carried out using the stated preference survey data. Three major classes of choice models were estimated using the stated preference data, multinomial logit, nested logit, and mixed multinomial logit. The results of these estimations were used to estimate values of time which ranged from \$10.13 for automobile travelers, to \$70.77 for commercial vehicle drivers. Revealed preference data from past studies and the concurrent origin-destination study were used to estimate revealed preference (RP) models. The RP model results were used to confirm the coefficient values and value of time estimates for the stated preference models.



CONTENTS

EXECUTIVE SUMMARY I

CONTENTS II

FIGURES III

TABLES V

APPENDICES VI

INTRODUCTION 7

SURVEY APPROACH 8

SURVEY INSTRUMENT 8

 AUTOMOBILE SURVEY QUESTIONNAIRE 9

 COMMERCIAL VEHICLE DRIVER SURVEY QUESTIONNAIRE 19

 COMMERCIAL VEHICLE DECISION MAKER SURVEY QUESTIONNAIRE 25

SURVEY ADMINISTRATION 30

 AUTOMOBILE SURVEY ADMINISTRATION 31

 COMMERCIAL VEHICLE DRIVER SURVEY ADMINISTRATION 34

 COMMERCIAL VEHICLE DECISION MAKER SURVEY ADMINISTRATION 36

SURVEY RESULTS 37

 AUTOMOBILE RESULTS 37

 COMMERCIAL VEHICLE DRIVER RESULTS 49

 COMMERCIAL VEHICLE DECISION MAKER RESULTS 63

STATED PREFERENCE MODEL ESTIMATION 76

 METHODOLOGY AND ALTERNATIVES 76

 IDENTIFICATION OF OUTLIERS 77

 MULTINOMIAL LOGIT MODEL ESTIMATION 77

 NESTED LOGIT MODEL ESTIMATION 81

 MIXED LOGIT MODEL ESTIMATION 86

REVEALED PREFERENCE MODEL ESTIMATION 89

 AUTOMOBILE REVEALED PREFERENCE MODEL ESTIMATION 89

 COMMERCIAL VEHICLE REVEALED PREFERENCE MODEL ESTIMATION 89



FIGURES

Figure 1: Study Area	7
Figure 2: Crossings Used in the Last Month	9
Figure 3: Automobile Survey – Trip Purpose	10
Figure 4: Automobile Survey – Origin Address Screen.....	11
Figure 5: Automobile Survey – Origin Map Screen	11
Figure 6: Automobile Survey – Travel Time Warning Screen.....	12
Figure 7: Automobile Survey – Stated Preference Information Screen.....	13
Figure 8: Automobile Survey – Example Stated Preference Screen.....	14
Figure 9: Automobile Survey – Stated Preference Debrief.....	17
Figure 10: Automobile Survey – Example Max-Diff Exercise.....	18
Figure 11: Automobile Survey – Primary Reason in Favor Screen	19
Figure 12: Commercial Vehicle Driver Survey – Vehicle Type.....	20
Figure 13: Commercial Vehicle Driver Survey – Example Stated Preference Screen	22
Figure 14: Commercial Vehicle Decision Maker Survey – Trip Details Screen	26
Figure 15: Commercial Vehicle Decision Maker Survey – Example Stated Preference Screen.....	28
Figure 16: Automobile Survey – Intercept Locations Map.....	32
Figure 17: Stated Preference Survey Invitation Postcard	33
Figure 18: Automobile Survey – Invitation in the Wayne State University Campus Newsletter.....	34
Figure 19: Commercial Vehicle Driver Survey – Intercept Locations Map	35
Figure 20: Automobile Results – Crossings Used in the Past Month (Select All That Apply)	37
Figure 21: Automobile Results – Crossing Used on Reported Trip.....	38
Figure 22: Automobile Results – Trip Direction by Crossing.....	38
Figure 23: Automobile Results – Heavy Traffic Delay by Crossing.....	41
Figure 24: Automobile Results – Time Spent in the Queue at the Border by Crossing	42
Figure 25: Automobile Results – Stated Preference Behavior by Crossing.....	43
Figure 26: Automobile Results – Primary Reason for Never Selecting the New Bridge Option by Crossing.....	44
Figure 27: Automobile Results – Primary Reason for Selecting the New Bridge Option by Crossing.....	45
Figure 28: Automobile Results – MaxDiff Scaled Utilities	46
Figure 29: Automobile Results – Opinion of Proposed New Bridge by Country of Residence	47
Figure 30: Automobile Results – Primary Reason New Bridge Favored by Country of Residence	47
Figure 31: Automobile Results – Primary Reason New Bridge Opposed by Country of Residence.....	48
Figure 32: Automobile Results – Annual Household Income	49



Figure 33: Commercial Vehicle Driver Results – Crossings Used in the Past Month.....50

Figure 34: Commercial Vehicle Driver Results – Crossing Used on Reported Trip.....50

Figure 35: Commercial Vehicle Driver Results – Trip Direction by Crossing.....51

Figure 36: Commercial Vehicle Driver Results – Vehicle and Trailer Type by Crossing.....52

Figure 37: Commercial Vehicle Driver Results – Gross Vehicle Weight to the Nearest 1,000 lbs by
Crossing.....53

Figure 38: Commercial Vehicle Driver Results – Heavy Traffic Delay by Crossing.....55

Figure 39: Commercial Vehicle Driver Results – Time Spent in the Queue at the Border by Crossing.....56

Figure 40: Commercial Vehicle Driver Results – Stated Preference Behavior by Crossing.....57

Figure 41: Commercial Vehicle Driver Results – Primary Reason for Never Selecting the New Bridge
Option by Crossing.....58

Figure 42: Commercial Vehicle Driver Results – Primary Reason for Selecting New Bridge by Crossing.....59

Figure 43: Commercial Vehicle Driver Results – MaxDiff Scaled Utilities.....60

Figure 44: Commercial Vehicle Driver Results – Opinion of New Bridge by Company Headquarters
Location.....61

Figure 45: Commercial Vehicle Driver Results – Primary Reason New Bridge Favored by Company
Headquarters Location.....62

Figure 46: Commercial Vehicle Decision Maker Results – Crossing Used in the Past Month.....63

Figure 47: Commercial Vehicle Decision Maker Results – Crossing Used on Reported Trip.....64

Figure 48: Commercial Vehicle Decision Maker Results – Vehicle Type by Crossing.....64

Figure 49: Commercial Vehicle Decision Maker Results – Vehicle Weight to the Nearest 1,000 lbs by
Crossing.....65

Figure 50: Commercial Vehicle Decision Maker Results – Travel Time by Crossing.....67

Figure 51: Commercial Vehicle Decision Maker Results – Heavy Traffic Delay by Crossing.....68

Figure 52: Commercial Vehicle Decision Maker Results – Time Spent in the Queue at the Border by
Crossing.....69

Figure 53: Commercial Vehicle Decision Maker Results – Stated Preference Behavior by Crossing.....70

Figure 54: Commercial Vehicle Decision Maker Results – Primary Reason for Never Selecting New
Bridge Option by Crossing.....71

Figure 55: Commercial Vehicle Decision Maker Results – Primary Reason for Selecting New Bridge
Option by Crossing.....72

Figure 56: Commercial Vehicle Decision Maker Results – MaxDiff Scaled Utilities.....73

Figure 57: Commercial Vehicle Decision Maker Results – Opinion of New Bridge by Crossing.....74

Figure 58: Commercial Vehicle Decision Maker Results – Primary Reason New Bridge Favored by
Crossing.....75

Figure 59: Sample Nested Logit Structure Represented by a Tree Diagram.....81



Figure 60: Nesting Structure 182
 Figure 61: Nesting Structure 2.....84
 Figure 62: Automobile Value of Time Distribution.....88
 Figure 63: Commercial Vehicle Driver Value of Time Distribution.....88

TABLES

Table 1: Automobile Survey – Stated Preference Attributes and Levels15
 Table 2: MaxDiff Attributes.....18
 Table 3: Commercial Vehicle Driver Survey – Stated Preference Attributes and Levels23
 Table 4: Commercial Vehicle Decision Maker Survey – Stated Preference Attributes and Levels.....29
 Table 5: Automobile Survey – Respondent Source.....31
 Table 6: Automobile Survey – Complete Surveys by Intercept Location31
 Table 7: Commercial Vehicle Driver Survey – Complete Surveys by Intercept Location.....36
 Table 8: Automobile Results – Bridge Purpose by Crossing.....39
 Table 9: Automobile Results – Trip Purpose by Crossing.....39
 Table 10: Automobile Results – Trip Purpose by Crossing by Time of Day40
 Table 11: Automobile Results – Travel Time by Crossing Time.....40
 Table 12: Commercial Vehicle Driver Results – Bridge Purpose by Crossing53
 Table 13: Commercial Vehicle Driver Results – Travel Time by Crossing Time54
 Table 14: Commercial Vehicle Decision Maker Results – Bridge Purpose by Crossing.....66
 Table 15: Stated Preference Observations.....77
 Table 16: MNL Model specification for Automobile and Commercial Vehicle Data.....78
 Table 17: Automobile MNL Coefficients78
 Table 18: Commercial Vehicle Driver MNL Coefficients79
 Table 19: Commercial Vehicle Decision Maker MNL Coefficients.....79
 Table 20: Automobile MNL Coefficients Segmented by Trip Distance80
 Table 21: Commercial Vehicle Driver MNL Coefficients Segmented by Trip Distance.....80
 Table 22: Commercial Vehicle Decision Maker MNL Coefficients Segmented by Trip Distance80
 Table 23: MNL Values of Time.....81
 Table 24: Automobile Nested Logit Model Coefficients for Nesting Structure 182
 Table 25: Commercial Vehicle Driver Nested Logit Model Coefficients for Nesting Structure 183
 Table 26: Commercial Vehicle Decision Maker Nested Logit Model Coefficients for Nesting Structure 1
83
 Table 27: Automobile Nested Logit Model Coefficients for Nesting Structure 284



Table 28: Commercial Vehicle Driver Nested Logit Model Coefficients for Nesting Structure 285

Table 29: Commercial Vehicle Decision Maker Nested Logit Model Coefficients for Nesting Structure 2
.....85

Table 30: NL Values of Time86

Table 31: Automobile Mixed Logit Coefficients87

Table 32: Commercial Vehicle Driver Mixed Logit Coefficients.....87

Table 33: Automobile Revealed Preference Coefficients89

Table 34: Facility Toll Rates for Commercial Vehicles.....90

Table 35: Commercial Vehicle Revealed Preference Coefficients90

APPENDICES

- Appendix A: Automobile Questionnaire
- Appendix B: Commercial Vehicle Driver Questionnaire
- Appendix C: Commercial Vehicle Decision Maker Questionnaire
- Appendix D: Automobile Tabulations
- Appendix E: Commercial Vehicle Driver Tabulations
- Appendix F: Commercial Vehicle Decision Maker Tabulations
- Appendix G: Automobile Screen Captures
- Appendix H: Commercial Vehicle Driver Screen Captures
- Appendix I: Commercial Vehicle Decision Maker Screen Captures
- Appendix J: Automobile Comments
- Appendix K: Commercial Vehicle Driver Comments
- Appendix L: Commercial Vehicle Decision Maker Comments



INTRODUCTION

Transport Canada, in partnership with the Ontario Ministry of Transportation (MTO), the Michigan Department of Transportation (MDOT), and the Federal Highway Administration (FHWA), is currently evaluating plans to build a new bridge spanning the Detroit River between Detroit, MI and Windsor, ON. The proposed bridge would help manage travel demand and reduce congestion through this international gateway. This report details the study design, data collection methodology, and model results of the Windsor Gateway Stated Preference Survey conducted by study team member, Resource Systems Group, Inc. (RSG). RSG served as a subconsultant to Wilbur Smith Associates for this project, which is being conducted for Transport Canada.

Data collection began in April 2008 and concluded in June 2008. The survey collected data from travelers who had recently used one of the three existing crossings between Michigan and Ontario: the Ambassador Bridge, the Detroit-Windsor Tunnel, and the Blue Water Bridge (Figure 1). The main purpose of the Windsor Gateway Stated Preference Study was to estimate travelers' values of time and propensity to use the proposed new bridge crossing under different travel time and toll cost conditions. The resultant values of time and propensities to use the bridge will be used as inputs to the traffic forecasting process, supporting the development of the traffic and toll revenue forecasts for the proposed crossing.

Figure 1: Study Area



SURVEY APPROACH

The stated preference survey questionnaire was designed and administered to identify the travel patterns and preferences of automobile and commercial vehicle drivers who currently use the Ambassador Bridge, the Detroit-Windsor Tunnel, or the Blue Water Bridge between Michigan and Ontario. Some commercial vehicle drivers do not make their own route choice decisions, but are instead directed by fleet managers or dispatchers. Therefore, data were also collected from a sample of these commercial vehicle routing decision makers.

The survey approach employed a computer-assisted self-interview (CASI) technique developed by RSG. After developing and refining the survey questionnaire, the final version was programmed for administration on laptop computers and over the internet via targeted email distribution. The stated preference survey instrument was customized for each respondent by presenting questions and modifying wording based on respondents' previous answers. These dynamic survey features provide an accurate and efficient means of data collection and allow presentation of realistic future conditions that correspond with the respondents' reported experiences.

Having both intercept and online completion options allows for the sampling of a wide range of travelers across income, age, and other demographic factors. In particular, the online completion option is a cost effective way to reach a large number of respondents and can boost participation from segments of the population that typically have low response rates, namely individuals who are younger, more affluent, and highly educated.



SURVEY INSTRUMENT

The automobile and commercial vehicle survey instruments were designed to capture revealed preference data about trips that respondents currently make between Michigan and Ontario, stated preference data about trips they could make in the future, and opinion and demographic data for classification purposes.

At the beginning of the survey, respondents reported if they had made a trip within the past month that was at least 15 minutes long and used the Ambassador Bridge, the Detroit-Windsor Tunnel or the Blue Water Bridge (Figure 2). These screening criteria, in combination with the validation of reported trip origins and destinations, ensured that respondents focused on a trip that in the future could reasonably use the proposed new bridge. Respondents were asked to keep the details of this recent trip in mind as they completed the questionnaire.




Figure 2: Crossings Used in the Last Month

DETROIT RIVER INTERNATIONAL CROSSING STUDY

Have you made a trip within the past month that was at least 15 minutes long and used one of the following crossings?

Please select all that apply.



Yes, I used the Blue Water Bridge

Yes, I used the Detroit-Windsor Tunnel

Yes, I used the Ambassador Bridge

No, I have not made a trip within the past month that used any of the above crossings

NEXT QUESTION ▶

Questions or problems? Please call toll-free 1-888-774-5984 or email windgate@surveycafe.com.

AUTOMOBILE SURVEY QUESTIONNAIRE

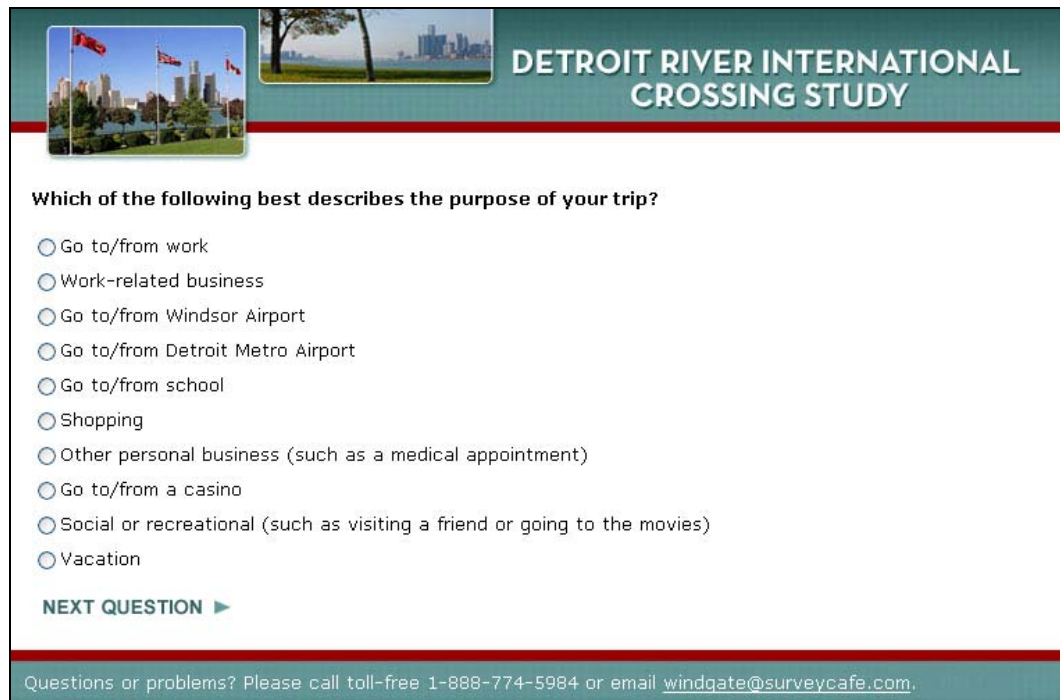
The automobile questionnaire asked questions grouped into six sections: recent trip characteristics, a set of stated preference tradeoff exercises, debrief questions about the stated preference exercises, a set of ranking exercises, a set of general opinion questions, and several demographics questions. The text of the automobile questionnaire is included in Appendix A and example survey screens are included in Appendix G.



Automobile Recent Trip Context Questions

Having met the screening criteria, automobile respondents provided details about their most recent trip that used the Ambassador Bridge, the Detroit-Windsor Tunnel, or the Blue Water Bridge. Respondents began the survey by indicating the crossing used for their trip and the direction in which they used the crossing. Respondents also reported details of their trip including trip purpose, origin and destination, day of the week, time of the day, total travel time, amount of time delayed and toll cost (Figure 3).

Figure 3: Automobile Survey – Trip Purpose



**DETROIT RIVER INTERNATIONAL
CROSSING STUDY**

Which of the following best describes the purpose of your trip?

- Go to/from work
- Work-related business
- Go to/from Windsor Airport
- Go to/from Detroit Metro Airport
- Go to/from school
- Shopping
- Other personal business (such as a medical appointment)
- Go to/from a casino
- Social or recreational (such as visiting a friend or going to the movies)
- Vacation

NEXT QUESTION ►

Questions or problems? Please call toll-free 1-888-774-5984 or email windgate@surveycafe.com.

Each automobile respondent indicated the type of locations where their trip began and ended, such as the home or workplace. Respondents then pinpointed the exact locations by entering an address or clicking on an interactive map (Figures 4 and 5). The origins and destinations were geocoded to a latitude and longitude and assigned to a traffic analysis zone (TAZ) of the network model supplied by IBI Group. If trips began or ended outside of the Detroit-Windsor area, respondents were only asked to enter a city and state/province.



Figure 4: Automobile Survey – Origin Address Screen

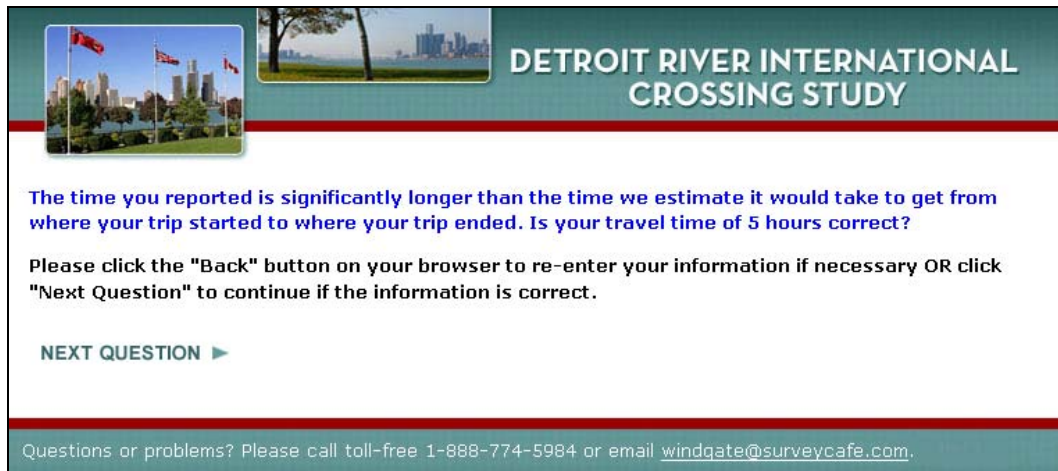
Figure 5: Automobile Survey – Origin Map Screen



Some respondents indicated a travel route that did not have the possibility of using the proposed bridge and were screened out of the rest of the survey. These were often relatively short trips across the Blue Water Bridge, or trips that had both origin and destination on the same side of the international border.

Respondents were asked to report their total door-to-door travel times. Travel times could be entered in intervals of five minutes, ranging from five minutes to eleven hours and fifty-five minutes. If the reported travel time was 250% greater than or 50% less than the travel time indicated by the regional network model, respondents were shown a warning (Figure 6) and asked, but not required, to go back and change their travel time. Respondents were also asked to estimate any delays either due to traffic or time spent in the queue at the border crossing.

Figure 6: Automobile Survey – Travel Time Warning Screen



The last few questions in this section of the survey instrument asked respondents how much they paid for tolls both on their reported crossing and on other roads, and if they owned an electronic toll collection (ETC) transponder.

Automobile Stated Preference Questions

As an introduction to the stated preference tradeoff exercises, respondents were presented with information about the new bridge and the travel alternatives that would be presented to them in the following questions (Figure 7).



Figure 7: Automobile Survey – Stated Preference Information Screen




DETROIT RIVER INTERNATIONAL CROSSING STUDY

Please read and click "Next Question" to continue.

A new bridge over the Detroit River is proposed. It will provide a freeway connection between I-75 in Detroit and Highway 401 in Windsor, bypassing 16 traffic lights along the route to and from the existing crossings.

Tolls on the new bridge would be collected with cash and electronic toll collection (ETC). Electronic tolls would be paid with a transponder mounted on your windshield.



NEXT QUESTION ►

Questions or problems? Please call toll-free 1-888-774-5984 or email windgate@surveycafe.com.

The stated preference section of the questionnaire consisted of eight hypothetical tradeoff scenarios designed to evaluate respondents' travel preferences across a range of travel times and toll costs. Each scenario included three or four crossing alternatives. The Ambassador Bridge, the Detroit-Windsor Tunnel, and the new bridge were always presented as alternatives. The Blue Water Bridge was presented as an alternative if the respondent used it for their reported trip or, if they did not use it for their reported trip, if it was determined to be a reasonable alternative to the crossing they did use. For the purposes of this survey, the Blue Water Bridge was considered a reasonable alternative if the estimated travel time over the Blue Water Bridge was less than 45 minutes longer than the estimated travel time over using the respondents' reported crossing. In each of the eight scenarios, respondents were asked to make a choice based on the conditions presented to them (Figure 8). Specific details in the hypothetical alternatives were customized based on responses to the recent trip context questions.



Each alternative included information about travel time and toll cost. Across all scenarios, the respondent was presented with different levels of each of these attributes and asked to “tradeoff” between the choice alternatives.

Figure 8: Automobile Survey – Example Stated Preference Screen

DETROIT RIVER INTERNATIONAL CROSSING STUDY

Remember, please think about your most recent trip into Canada using the Ambassador Bridge as you answer these questions.

Now which option would you choose?

Remember to keep in mind the trip you described earlier when answering these questions.

<input type="radio"/> Blue Water Bridge (Port Huron-Point Edward) Travel time: 1 hr. 17 mins. Toll: \$7.50	<input type="radio"/> Detroit-Windsor Tunnel (Detroit-Windsor) Travel time: 1 hr. 29 mins. Toll: \$2.50
<input type="radio"/> New Bridge (Detroit-Windsor) Travel time: 1 hr. 31 mins. Toll: \$4.50	<input type="radio"/> Current crossing on Ambassador Bridge Travel time: 1 hr. 22 mins. Toll: \$5.00

NEXT QUESTION ► Question 5 of 8

Questions or problems? Please call toll-free 1-888-774-5984 or email windgate@surveycafe.com.

The combination of time and cost levels presented in each experiment was selected using a fractional factorial orthogonal experimental design, a commonly used experimental design method which collects information from respondents in a statistically efficient manner. The experimental design consisted of 64 experiments which were divided into eight groups. Each respondent saw one of the eight groups of experiments, which were presented in a random order.

To ensure that the scenarios were believable to each respondent, the base values for travel times and toll cost were based on characteristics of the recent trip reported by the respondent. The base values for the attributes were varied by adding one of several factors to give the level required by the experimental design for that particular scenario. By varying the travel times and toll shown in each scenario, the respondent was faced with different time savings for different costs, allowing them to demonstrate their travel preferences across a range of values of time. Table 1 describes the



automobile attributes and levels. The formulas used for calculating the levels for each attribute are included in the automobile survey script in Appendix A.

Table 1: Automobile Survey – Stated Preference Attributes and Levels

Alternative 1: Current Crossing	Alternative 2: Proposed New Bridge
<p>Travel time (Reported Travel Time)</p> <ul style="list-style-type: none"> Travel time + 7.5 minutes Travel time + 2.5 minutes Travel time – 2.5 minutes Travel time – 7.5 minutes 	<p>Travel time (Travel Time from Skims)</p> <ul style="list-style-type: none"> Travel time + 3 minutes Travel time + 1 minutes Travel time – 1 minutes Travel time – 3 minutes
<p>Toll Cost:</p> <ul style="list-style-type: none"> \$2.00 + tolls reported on other roads \$2.75 + tolls reported on other roads \$3.50 + tolls reported on other roads \$4.25 + tolls reported on other roads \$5.00 + tolls reported on other roads \$5.75 + tolls reported on other roads \$6.50 + tolls reported on other roads \$7.25 + tolls reported on other roads 	<p>Toll Cost:</p> <p>Additional toll is <u>added</u> if travel time is <u>shorter</u> than travel time in current crossing scenario</p> <p>Additional toll is <u>subtracted</u> if travel time is <u>longer</u> than travel time in current crossing scenario</p> <ul style="list-style-type: none"> \$0.50 +/- toll for current crossing scenario \$1.00 +/- toll for current crossing scenario \$1.50 +/- toll for current crossing scenario \$2.00 +/- toll for current crossing scenario \$2.50 +/- toll for current crossing scenario \$3.00 +/- toll for current crossing scenario \$3.50 +/- toll for current crossing scenario \$4.00 +/- toll for current crossing scenario



Alternative 3	Alternative 4 (if appropriate)
<p>Travel time (Travel Time from skims)</p> <p>Travel time + 3 minutes</p> <p>Travel time + 1 minutes</p> <p>Travel time – 1 minutes</p> <p>Travel time – 3 minutes</p>	<p>Travel time (Travel Time from skims)</p> <p>Travel time + 3 minutes</p> <p>Travel time + 1 minutes</p> <p>Travel time – 1 minutes</p> <p>Travel time – 3 minutes</p>
<p>Toll Cost:</p> <p>Additional toll is <u>added</u> if travel time is <u>shorter</u> than travel time in current crossing scenario</p> <p>Additional toll is <u>subtracted</u> if travel time is <u>longer</u> than travel time in current crossing scenario</p> <p>\$0.50 +/- toll for current crossing scenario</p> <p>\$1.00 +/- toll for current crossing scenario</p> <p>\$1.50 +/- toll for current crossing scenario</p> <p>\$2.00 +/- toll for current crossing scenario</p> <p>\$2.50 +/- toll for current crossing scenario</p> <p>\$3.00 +/- toll for current crossing scenario</p> <p>\$3.50 +/- toll for current crossing scenario</p> <p>\$4.00 +/- toll for current crossing scenario</p>	<p>Toll Cost:</p> <p>Additional toll is <u>added</u> if travel time is <u>shorter</u> than travel time in current crossing scenario</p> <p>Additional toll is <u>subtracted</u> if travel time is <u>longer</u> than travel time in current crossing scenario</p> <p>\$0.50 +/- toll for current crossing scenario</p> <p>\$1.00 +/- toll for current crossing scenario</p> <p>\$1.50 +/- toll for current crossing scenario</p> <p>\$2.00 +/- toll for current crossing scenario</p> <p>\$2.50 +/- toll for current crossing scenario</p> <p>\$3.00 +/- toll for current crossing scenario</p> <p>\$3.50 +/- toll for current crossing scenario</p> <p>\$4.00 +/- toll for current crossing scenario</p>

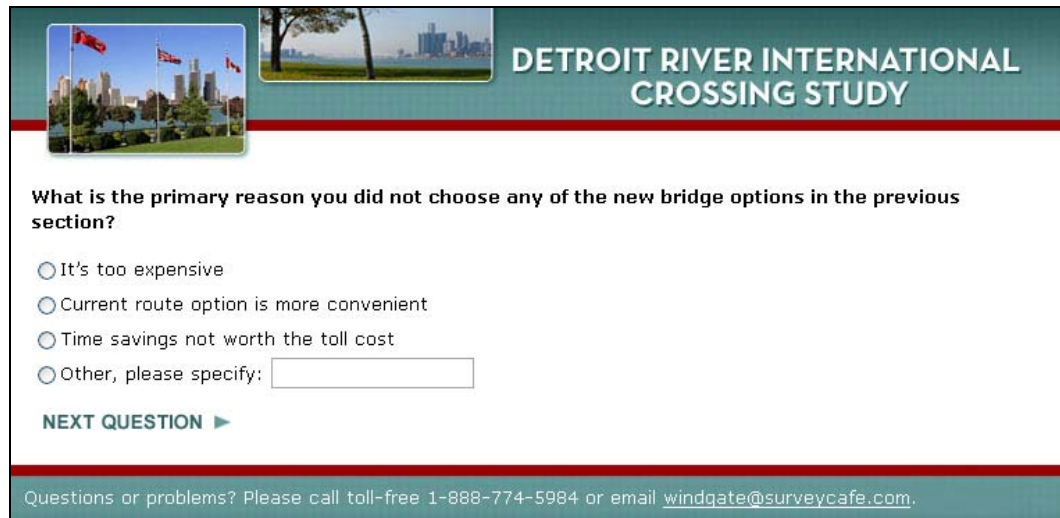
Note: Costs rounded to nearest five cents and times rounded to nearest minute.

Automobile Stated Preference Debrief Questions

At the conclusion of the stated preference exercises, a set of debrief questions were asked to help explain respondents’ choices. Those who did not choose the new bridge crossing in any of the stated preference scenarios were asked to indicate their primary reason for this response pattern (Figure 9). Alternatively, respondents who chose the new bridge crossing at least once were asked why they did so. The answer options were randomly ordered in these questions to minimize potential order bias.



Figure 9: Automobile Survey – Stated Preference Debrief



DETROIT RIVER INTERNATIONAL CROSSING STUDY

What is the primary reason you did not choose any of the new bridge options in the previous section?

It's too expensive
 Current route option is more convenient
 Time savings not worth the toll cost
 Other, please specify:

NEXT QUESTION ►

Questions or problems? Please call toll-free 1-888-774-5984 or email windgate@surveycafe.com.

Automobile MaxDiff Questions

A best-worst conjoint, also called a MaxDiff conjoint, was conducted to determine the relative importance of different features or characteristics of the crossings that might affect route choice decisions. A MaxDiff conjoint is an analytic technique that allows for the estimation of the relative importance of a set of attributes based on data from tradeoff experiments. In each experiment, the respondent was asked to choose the most important (best) and least important (worst) of a set of attributes related to their trip between Michigan and Ontario. Statistical analysis of the tradeoff data results in a set of coefficients that show the relative importance of each attribute in the conjoint.

A MaxDiff design was created in which seven scenarios were shown to respondents. Each scenario consisted of four attributes related to a hypothetical border crossing. Respondents were asked to choose the one attribute that was most important to them and the one attribute that was least important to them (Figure 10). These data were used to calculate the relative importance of a total of 14 factors that would be considered in the selection of an international river crossing. Table 2 summarizes the 14 MaxDiff attributes presented to respondents.



Figure 10: Automobile Survey – Example Max-Diff Exercise

DETROIT RIVER INTERNATIONAL CROSSING STUDY

Below is a list of 4 features or benefits that could be available to travelers crossing between the U.S. and Canada.

Please read each feature carefully. Then, indicate the ONE that is the MOST IMPORTANT to you by selecting a button on the left and the one feature that is LEAST IMPORTANT to you by selecting a button on the right.

When you have finished making your decisions, please click "Next Question" to continue.

Which one of the following is MOST IMPORTANT and which one is the LEAST IMPORTANT to you for your work trip traveling into Canada?

Most Important		Least Important
<input type="radio"/>	Receive a free trip on the crossing for every 10 tolls paid	<input type="radio"/>
<input type="radio"/>	Crossing has freeway width lanes	<input type="radio"/>
<input type="radio"/>	Easy access to downtown Windsor amenities	<input type="radio"/>
<input type="radio"/>	Save 5 minutes at customs compared to other crossings	<input type="radio"/>

Question 1 of 7

NEXT QUESTION ►

Questions or problems? Please call toll-free 1-888-774-5984 or email windgate@surveycafe.com.

Table 2: MaxDiff Attributes

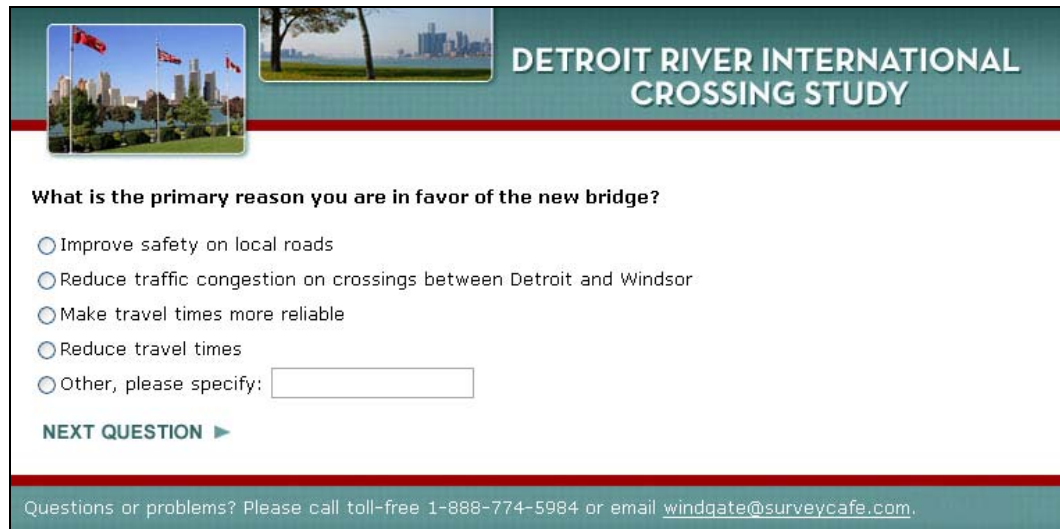
1	Receive vouchers for duty free shops in return for your toll
2	Receive a free trip on the crossing for every 10 tolls paid
3	Pavement on crossing is well maintained
4	Crossing has freeway width lanes
5	Crossing is aesthetically pleasing to drive over
6	Crossing is well lit at night
7	Pay toll using a transponder and don't stop at a toll booth
8	Few traffic signals on the approaches to the crossing
9	Freeway access to the crossing
10	Easy access to downtown Windsor amenities
11	Easy access to downtown Detroit amenities
12	Save \$2 on toll compared to other crossings
13	Save 10 minutes in travel time compared to other crossings
14	Save 5 minutes at customs compared to other crossings



Automobile Opinion Questions

The next set of questions addressed respondents' opinions about the new bridge. First, respondents indicated their overall support or opposition for the project. Those who said they "strongly favor" or "somewhat favor" the project were shown a follow-up question asking their primary reason for favoring the project (Figure 11). Alternatively, those who said they "somewhat oppose" or "strongly oppose" the project were asked to indicate their primary reason for opposing the project.

Figure 11: Automobile Survey – Primary Reason in Favor Screen



DETROIT RIVER INTERNATIONAL CROSSING STUDY

What is the primary reason you are in favor of the new bridge?

Improve safety on local roads

Reduce traffic congestion on crossings between Detroit and Windsor

Make travel times more reliable

Reduce travel times

Other, please specify:

NEXT QUESTION ►

Questions or problems? Please call toll-free 1-888-774-5984 or email windgate@surveycafe.com.

Automobile Demographic Questions

The final section of the questionnaire consisted of several demographics question to determine differences in responses among different traveler segments. Respondents were assured that their responses would be kept confidential and that any personal information they recorded would not be shared or sold to a third party.

Respondents answered a series of questions regarding county of residence, household size, number of household vehicles, gender, age, employment status, occupation, access to the Internet and annual income.

At the conclusion of the survey, respondents were given the opportunity to leave comments about the survey or about the new bridge. The automobile respondent comments are reported in Appendix J.

COMMERCIAL VEHICLE DRIVER SURVEY QUESTIONNAIRE

The commercial vehicle questionnaire was generally similar to the automobile questionnaire and asked questions grouped into six sections: context questions that asked for details about the respondent's trip and role, a set of stated preference tradeoff exercises, debrief questions about the stated preference exercises, a set of ranking exercises, a set of general opinion questions, and

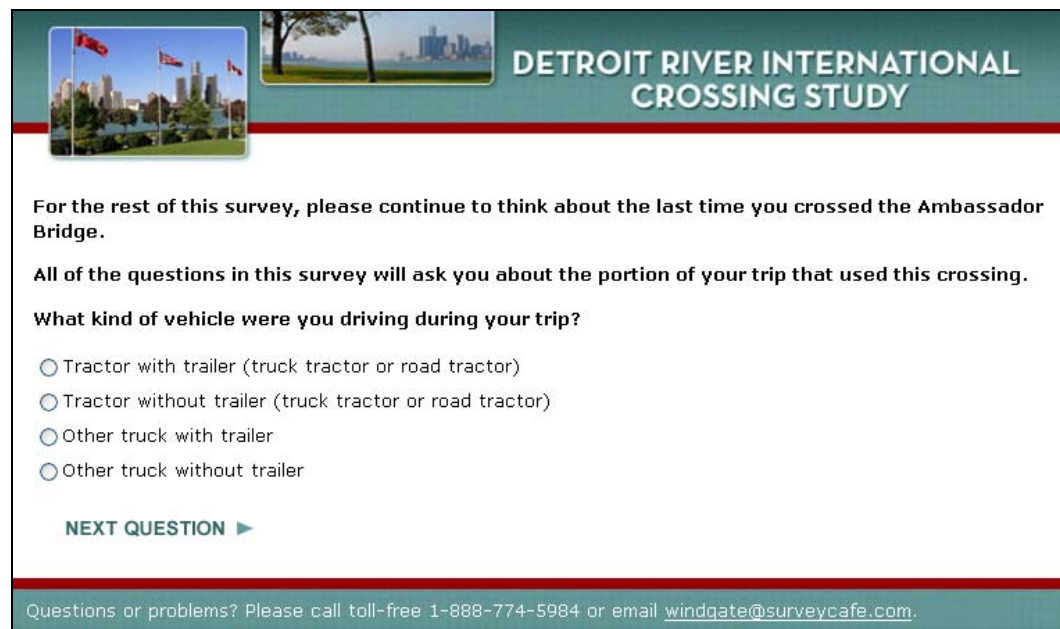


company background questions. The text of the commercial vehicle questionnaire is included in Appendix B and example survey screens are included in Appendix H.

Commercial Vehicle Driver Context Questions

Commercial vehicle drivers needed to meet the same screening criteria as automobile respondents, which included making a recent trip of 15 minutes or more using the Ambassador Bridge, the Detroit-Windsor Tunnel, or the Blue Water Bridge. Additional screening criteria required the driver to make at least some routing decisions. Having met the screening criteria, commercial vehicle respondents provided background information on their commercial vehicle company and their role as a driver. Next, the respondent reported the details of their trip which may have used the new bridge in the future, including the direction of travel, the route, vehicle type and cargo, vehicle weight, trip purpose, day of week, time of day, total travel time, trip frequency, and approximate amount of time delayed (Figure 12).

Figure 12: Commercial Vehicle Driver Survey – Vehicle Type



DETROIT RIVER INTERNATIONAL CROSSING STUDY

For the rest of this survey, please continue to think about the last time you crossed the Ambassador Bridge.

All of the questions in this survey will ask you about the portion of your trip that used this crossing.

What kind of vehicle were you driving during your trip?

- Tractor with trailer (truck tractor or road tractor)
- Tractor without trailer (truck tractor or road tractor)
- Other truck with trailer
- Other truck without trailer

NEXT QUESTION ►

Questions or problems? Please call toll-free 1-888-774-5984 or email windgate@surveycafe.com.

Commercial vehicle respondents were asked to identify the locations where their trip began and ended. As with the automobile survey, the origin and destination information was geocoded, and, in combination with validated travel times, used later in the survey to build the stated preference experiments. To conclude the context questions, commercial vehicle respondents were asked about tolls they paid on their trip and if they currently owned an ETC transponder.

Commercial Vehicle Driver Stated Preference Questions

Before beginning the stated preference tradeoff questions, respondents were provided with information about the proposed new bridge and introduced to the travel alternatives that would be



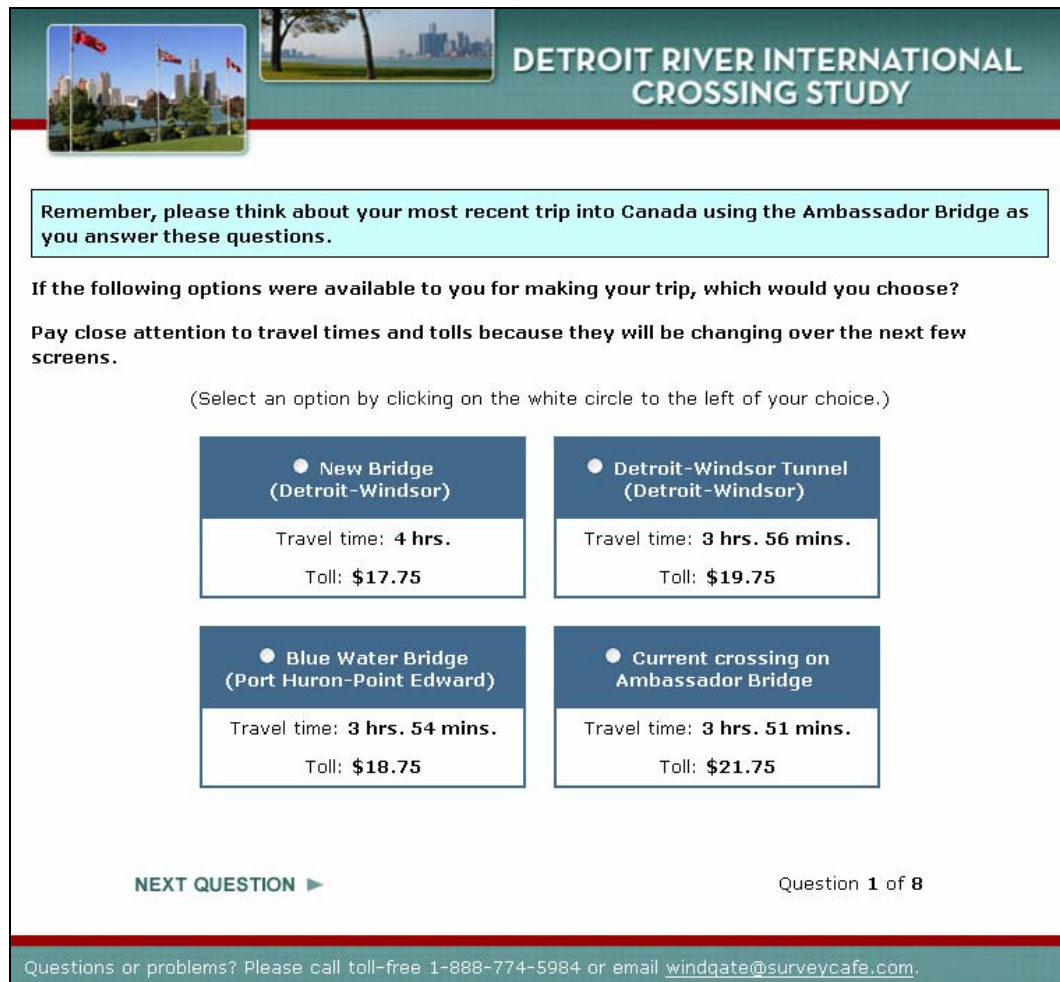
presented to them in the following questions. Like the automobile survey, the stated preference section of the commercial vehicle driver survey consisted of eight hypothetical tradeoff scenarios designed to evaluate respondents' travel preferences across a range of travel times and toll costs.

Each scenario included three or four crossing alternatives. The Ambassador Bridge, the Detroit-Windsor Tunnel, and the new bridge were always presented as alternatives. The Blue Water Bridge was presented as an alternative if the respondent used it for their reported trip or, if they did not use it for their reported trip, if it was determined to be a reasonable alternative to the crossing they did use. For the purposes of this survey, the Blue Water Bridge was considered a reasonable alternative if the estimated travel time over the Blue Water Bridge was less than 90 minutes longer than the estimated travel time over using the respondents' reported crossing. This is in contrast to the automobile survey, where the difference was capped at 45 minutes.

In each of the eight scenarios, respondents were asked to make a choice based on the conditions presented to them. Specific details in the hypothetical alternatives were customized based on responses to the recent trip context questions.



Figure 13: Commercial Vehicle Driver Survey – Example Stated Preference Screen



DETROIT RIVER INTERNATIONAL CROSSING STUDY

Remember, please think about your most recent trip into Canada using the Ambassador Bridge as you answer these questions.

If the following options were available to you for making your trip, which would you choose?

Pay close attention to travel times and tolls because they will be changing over the next few screens.

(Select an option by clicking on the white circle to the left of your choice.)

<input type="radio"/> New Bridge (Detroit-Windsor) Travel time: 4 hrs. Toll: \$17.75	<input type="radio"/> Detroit-Windsor Tunnel (Detroit-Windsor) Travel time: 3 hrs. 56 mins. Toll: \$19.75
<input type="radio"/> Blue Water Bridge (Port Huron-Point Edward) Travel time: 3 hrs. 54 mins. Toll: \$18.75	<input type="radio"/> Current crossing on Ambassador Bridge Travel time: 3 hrs. 51 mins. Toll: \$21.75

NEXT QUESTION ► Question 1 of 8

Questions or problems? Please call toll-free 1-888-774-5984 or email windgate@surveycafe.com.

Each alternative included information about travel time and toll cost. Across all scenarios, the respondent was presented with different levels of each of these attributes and asked to “tradeoff” between the choice alternatives.

The combination of time and cost levels presented in each experiment was selected using a fractional factorial orthogonal experimental design, a commonly used experimental design method which collects information from respondents in a statistically efficient manner. The experimental design consisted of 64 experiments which were divided into eight groups. Each respondent saw one of the eight groups of experiments, which were presented in a random order.

To ensure that the scenarios were believable to each respondent, the base values for travel times and toll cost were based on characteristics of the recent trip reported by the respondent. The base values for the attributes were varied by adding one of several factors to give the level required by the experimental design for that particular scenario. By varying the travel times and toll shown in each scenario, the respondent was faced with different time savings for different toll costs, allowing them



to demonstrate their travel preferences across a range of values of time. Table 3 describes the commercial vehicle driver attributes and levels. The formulas used for calculating the levels for each attribute are included in the commercial vehicle script in Appendix B.

Table 3: Commercial Vehicle Driver Survey – Stated Preference Attributes and Levels

Alternative 1: Current Crossing	Alternative 2: Proposed New Bridge
<p>Travel time (Reported Travel Time)</p> <p>Travel time + 9 minutes</p> <p>Travel time + 3 minutes</p> <p>Travel time – 3 minutes</p> <p>Travel time – 9 minutes</p>	<p>Travel time (Travel Time from Skims)</p> <p>Travel time + 3 minutes</p> <p>Travel time + 1 minutes</p> <p>Travel time – 3 minutes</p> <p>Travel time – 1 minutes</p>
<p>Toll Cost:</p> <p>Toll for current crossing +</p> <p>+ 0.21*(Toll for crossing) + Other tolls</p> <p>+ 0.15*(Toll for crossing) + Other tolls</p> <p>+ 0.09*(Toll for crossing) + Other tolls</p> <p>+ 0.03*(Toll for crossing) + Other tolls</p> <p>– 0.03*(Toll for crossing) + Other tolls</p> <p>– 0.09*(Toll for crossing) + Other tolls</p> <p>– 0.15*(Toll for crossing) + Other tolls</p> <p>– 0.21*(Toll for crossing) + Other tolls</p>	<p>Toll Cost:</p> <p>Additional toll is <u>added</u> if travel time is <u>shorter</u> than travel time in current crossing scenario</p> <p>Additional toll is <u>subtracted</u> if travel time is <u>longer</u> than travel time in current crossing scenario</p> <p>\$1.00 +/- toll for current crossing scenario</p> <p>\$2.00 +/- toll for current crossing scenario</p> <p>\$3.00 +/- toll for current crossing scenario</p> <p>\$4.00 +/- toll for current crossing scenario</p> <p>\$5.00 +/- toll for current crossing scenario</p> <p>\$6.00 +/- toll for current crossing scenario</p> <p>\$7.00 +/- toll for current crossing scenario</p> <p>\$8.00 +/- toll for current crossing scenario</p>



Alternative 3	Alternative 4 (if appropriate)
Travel time (Travel Time from skims) Travel time + 3 minutes Travel time + 1 minutes Travel time – 3 minutes Travel time – 1 minutes	Travel time (Travel Time from skims) Travel time + 3 minutes Travel time + 1 minutes Travel time – 3 minutes Travel time – 1 minutes
Toll Cost: Additional toll is <u>added</u> if travel time is <u>shorter</u> than travel time in current crossing scenario Additional toll is <u>subtracted</u> if travel time is <u>longer</u> than travel time in current crossing scenario \$1.00 +/- toll for current crossing scenario \$2.00 +/- toll for current crossing scenario \$3.00 +/- toll for current crossing scenario \$4.00 +/- toll for current crossing scenario \$5.00 +/- toll for current crossing scenario \$6.00 +/- toll for current crossing scenario \$7.00 +/- toll for current crossing scenario \$8.00 +/- toll for current crossing scenario	Toll Cost: Additional toll is <u>added</u> if travel time is <u>shorter</u> than travel time in current crossing scenario Additional toll is <u>subtracted</u> if travel time is <u>longer</u> than travel time in current crossing scenario \$1.00 +/- toll for current crossing scenario \$2.00 +/- toll for current crossing scenario \$3.00 +/- toll for current crossing scenario \$4.00 +/- toll for current crossing scenario \$5.00 +/- toll for current crossing scenario \$6.00 +/- toll for current crossing scenario \$7.00 +/- toll for current crossing scenario \$8.00 +/- toll for current crossing scenario

Note: Costs rounded to nearest five cents and times rounded to nearest minute.

Commercial Vehicle Driver Stated Preference Debrief Questions

At the conclusion of the stated preference scenarios, respondents who did not choose the new bridge in any of the stated preference scenarios were shown a debrief question asking them to provide the primary reason why they never selected this option. Similarly, respondents who chose the new bridge crossing at least once were asked to provide a reason why. The answer options were randomly ordered in these questions to minimize potential order bias.

Commercial Vehicle Driver MaxDiff Questions

Commercial vehicle respondents completed a MaxDiff tradeoff exercise that was identical to the one presented to automobile respondents. This exercise involved selecting the most important and least important attribute for a trip across the international border. A MaxDiff design was created in which seven scenarios were shown to each respondent. In each scenario, respondents chose the most important and least important factor among a total of four factors. These data were used to calculate the relative importance of a total of 14 factors that would be considered in the selection of an international river crossing. For more information about the MaxDiff exercises and attributes, please see the section of this report titled “Automobile MaxDiff Questions”.



Commercial Vehicle Driver Opinion Questions

A set of questions addressed respondents' opinions about the new bridge. First, respondents indicated their overall support or opposition for the project. Those who said they "strongly favor" or "somewhat favor" the project were shown a follow-up question asking their primary reason for favoring the project. Alternatively, those who said they "somewhat oppose" or "strongly oppose" the project were also shown a follow-up question asking their primary reason for opposing the project.

Commercial Vehicle Driver Company Background Questions

The final set of commercial vehicle driver questions asked the respondent to indicate the location of the company headquarters, their average trip length, the type of goods typically carried, the type of delivery schedule (fixed or flexible), the timeframe structure (penalty or incentive), and the category of shipments.

At the conclusion of the commercial vehicle background questions, respondents were given the opportunity to leave comments about the survey or about the new bridge. These responses are provided in Appendix K.

COMMERCIAL VEHICLE DECISION MAKER SURVEY QUESTIONNAIRE

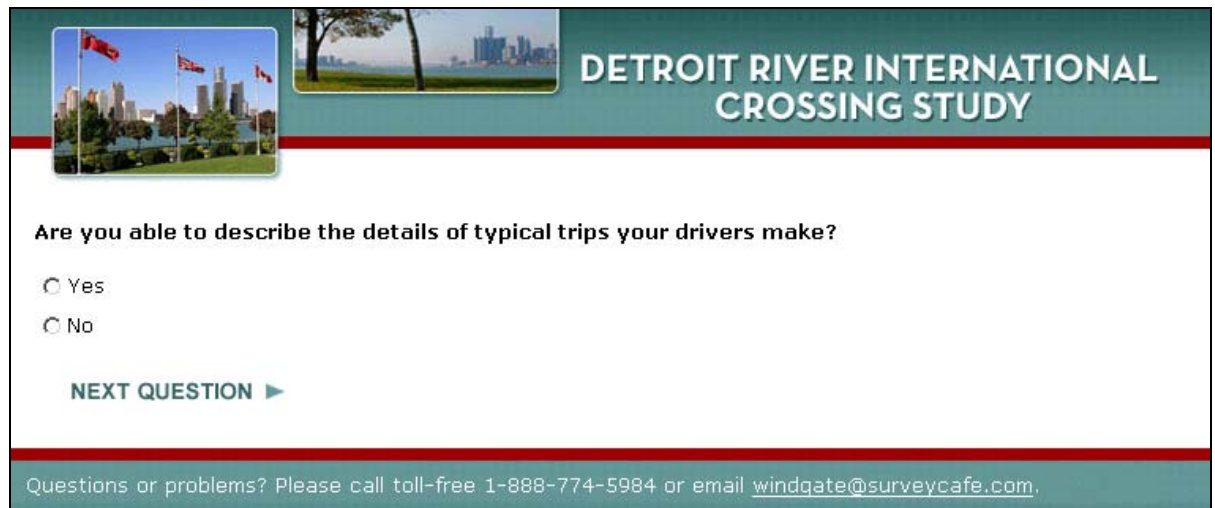
The commercial vehicle decision maker questionnaire was very similar to the commercial vehicle driver questionnaire, and consisted of six main sections: context questions about trips made by the respondent's fleet and their role in the routing process, stated preference tradeoff exercises, stated preference debrief questions; MaxDiff tradeoff exercises; a set of general opinions questions, and company background questions. Appendix C contains the text of the commercial vehicle decision maker questionnaire, while Appendix I includes screen captures from the online survey.

Commercial Vehicle Decision Maker Company Role and Trip Detail Questions

In order to qualify for the commercial vehicle decision maker survey, a respondent must have been a dispatcher, manager, or owner at his or her company who makes at least some routing decisions. Respondents were then asked if they could describe trips typically made by drivers in their fleet (Figure 14).



Figure 14: Commercial Vehicle Decision Maker Survey – Trip Details Screen



DETROIT RIVER INTERNATIONAL CROSSING STUDY

Are you able to describe the details of typical trips your drivers make?

Yes

No

NEXT QUESTION ►

Questions or problems? Please call toll-free 1-888-774-5984 or email windgate@surveycafe.com.

If the respondent could indeed describe company drivers' typical trips, he or she proceeded to document the crossings company drivers used within the past month for trips at least 15 minutes in duration. A single crossing was randomly selected when the respondent indicated company drivers' used multiple crossings. The respondent then described the direction company drivers travel when using this crossing and why they chose to use it when traveling in this direction. Other trip details reported by the respondent in the context section included vehicle type, vehicle size, trailer type, vehicle weight, trip origin and destination in relation to the Detroit-Windsor area, if stops were made in the Detroit-Windsor area, days of travel, total travel time, FAST lane use, length of heavy traffic and customs delays, ETC use, and trip frequency.

The last two questions of the context section asked for the specific location of a company driver's typical origin and destination for trips that crossed the Detroit River. The respondent provided the city and province or state of a driver's typical origin and destinations. These locations were then geocoded and validated to ensure that a typical trip described by the respondent would indeed use the Ambassador Bridge, the Detroit-Windsor Tunnel, or the Blue Water Bridge.

Commercial Vehicle Decision Maker Stated Preference Questions

The stated preference section began with a description of the proposed bridge crossing and the tradeoff exercises that would be presented in the following screens. Each respondent then answered a set of eight hypothetical tradeoff scenarios designed to evaluate their travel preferences for their fleet of vehicles across a range of travel times and toll costs.

Each scenario included three or four crossing alternatives. The Ambassador Bridge, the Detroit-Windsor Tunnel, and the new bridge were always presented as alternatives. The Blue Water Bridge was presented as an alternative if it was the crossing the respondent described for their drivers' trips in the recent trip context questions. If it was not the crossing they described before, the Blue Water Bridge was presented if it was determined to be a reasonable alternative to the crossing they did



describe. For the purposes of this survey, the Blue Water Bridge was considered a reasonable alternative if the estimated travel time over the Blue Water Bridge was less than 90 minutes longer than the estimated travel time over using the respondents' reported crossing. This is in contrast to the automobile survey, where the difference was capped at 45 minutes.

Each stated preference question asked the decision maker respondent to make a choice based on the travel time and toll cost conditions presented in each alternative. In contrast to the automobile and commercial vehicle driver survey, the alternatives presented to the decision maker respondent were not customized based on his or her answers in the context section. Because the decision makers might not know precise details of all of their drivers' trips, such as travel time and toll cost, the stated preference exercises presented the respondents with travel times and toll costs relative to the travel time and toll cost of a company driver's typical trip (Figure 15). Across all scenarios, the exercise presented the respondent with different levels for these attributes and asked them to "tradeoff" between the alternatives.



Figure 15: Commercial Vehicle Decision Maker Survey – Example Stated Preference Screen

DETROIT RIVER INTERNATIONAL CROSSING STUDY

Remember, please think about your driver's trips using the Detroit-Windsor Tunnel as you answer these questions.

If the following options were available to your drivers for making their trip, which would you choose?

Pay close attention to travel times and tolls because they will be changing over the next few screens.

(Select an option by clicking on the white circle to the left of your choice.)

<input type="radio"/> Current crossing on Detroit-Windsor Tunnel Travel time: Same time as trip takes now Toll: Same as trip costs now	<input type="radio"/> Blue Water Bridge (Port Huron-Point Edward) Travel time: 9 minutes more than trip takes now. Toll: \$3.00 less than trip costs now.
<input type="radio"/> New Bridge (Detroit-Windsor) Travel time: 5 minutes more than trip takes now. Toll: \$5.00 less than trip costs now.	<input type="radio"/> Ambassador Bridge (Detroit-Windsor) Travel time: 7 minutes more than trip takes now. Toll: \$9.00 less than trip costs now.

NEXT QUESTION ► Question 1 of 8

Questions or problems? Please call toll-free 1-888-774-5984 or email windgate@surveycafe.com.

The combination of time and cost levels presented in each experiment was selected using a fractional factorial orthogonal experimental design, a commonly used experimental design method which collects information from respondents in a statistically efficient manner. The experimental design consisted of 64 experiments which were divided into eight groups. Each respondent saw one of the eight groups of experiments, which were presented in a random order. Table 4 describes the attributes and levels for each alternative in the decision maker stated preference exercises. Additional information can be found in Appendix C.



Table 4: Commercial Vehicle Decision Maker Survey – Stated Preference Attributes and Levels

Alternative 1: Current Crossing	Alternative 2: Proposed New Bridge
<p>Travel time (Reported Travel Time)</p> <p>Travel time + 9 minutes</p> <p>Travel time + 3 minutes</p> <p>Travel time – 3 minutes</p> <p>Travel time – 9 minutes</p>	<p>Travel time (Travel Time from Skims)</p> <p>Travel time + 3 minutes</p> <p>Travel time + 1 minutes</p> <p>Travel time – 3 minutes</p> <p>Travel time – 1 minutes</p>
<p>Toll Cost:</p> <p>Toll for current crossing +</p> <p>+ 0.21*(Toll for crossing) + Other tolls</p> <p>+ 0.15*(Toll for crossing) + Other tolls</p> <p>+ 0.09*(Toll for crossing) + Other tolls</p> <p>+ 0.03*(Toll for crossing) + Other tolls</p> <p>– 0.03*(Toll for crossing) + Other tolls</p> <p>– 0.09*(Toll for crossing) + Other tolls</p> <p>– 0.15*(Toll for crossing) + Other tolls</p> <p>– 0.21*(Toll for crossing) + Other tolls</p>	<p>Toll Cost:</p> <p>Additional toll is <u>added</u> if travel time is <u>shorter</u> than travel time in current crossing scenario</p> <p>Additional toll is <u>subtracted</u> if travel time is <u>longer</u> than travel time in current crossing scenario</p> <p>\$1.00 +/- toll for current crossing scenario</p> <p>\$2.00 +/- toll for current crossing scenario</p> <p>\$3.00 +/- toll for current crossing scenario</p> <p>\$4.00 +/- toll for current crossing scenario</p> <p>\$5.00 +/- toll for current crossing scenario</p> <p>\$6.00 +/- toll for current crossing scenario</p> <p>\$7.00 +/- toll for current crossing scenario</p> <p>\$8.00 +/- toll for current crossing scenario</p>
Alternative 3	Alternative 4 (if appropriate)
<p>Travel time (Travel Time from skims)</p> <p>Travel time + 3 minutes</p> <p>Travel time + 1 minutes</p> <p>Travel time – 3 minutes</p> <p>Travel time – 1 minutes</p>	<p>Travel time (Travel Time from skims)</p> <p>Travel time + 3 minutes</p> <p>Travel time + 1 minutes</p> <p>Travel time – 3 minutes</p> <p>Travel time – 1 minutes</p>
<p>Toll Cost:</p> <p>Additional toll is <u>added</u> if travel time is <u>shorter</u> than travel time in current crossing scenario</p> <p>Additional toll is <u>subtracted</u> if travel time is <u>longer</u> than travel time in current crossing scenario</p> <p>\$1.00 +/- toll for current crossing scenario</p> <p>\$2.00 +/- toll for current crossing scenario</p> <p>\$3.00 +/- toll for current crossing scenario</p> <p>\$4.00 +/- toll for current crossing scenario</p> <p>\$5.00 +/- toll for current crossing scenario</p> <p>\$6.00 +/- toll for current crossing scenario</p> <p>\$7.00 +/- toll for current crossing scenario</p> <p>\$8.00 +/- toll for current crossing scenario</p>	<p>Toll Cost:</p> <p>Additional toll is <u>added</u> if travel time is <u>shorter</u> than travel time in current crossing scenario</p> <p>Additional toll is <u>subtracted</u> if travel time is <u>longer</u> than travel time in current crossing scenario</p> <p>\$1.00 +/- toll for current crossing scenario</p> <p>\$2.00 +/- toll for current crossing scenario</p> <p>\$3.00 +/- toll for current crossing scenario</p> <p>\$4.00 +/- toll for current crossing scenario</p> <p>\$5.00 +/- toll for current crossing scenario</p> <p>\$6.00 +/- toll for current crossing scenario</p> <p>\$7.00 +/- toll for current crossing scenario</p> <p>\$8.00 +/- toll for current crossing scenario</p>

Note: Costs rounded to nearest five cents and times rounded to nearest minute.



Commercial Vehicle Decision Maker Stated Preference Debrief, MaxDiff and Opinion Questions

After completing the stated preference exercises, commercial vehicle decision maker respondents were presented with the same set of stated preference debrief, MaxDiff, and opinion questions as the commercial vehicle drivers. For more information about these questions, please see the section titled “Commercial Vehicle Driver”.

Commercial Vehicle Decision Maker Company Background Questions

The commercial vehicle decision maker survey then presented the respondent with a number of questions about his or her company. Specifically, this last section of questions asked the respondent how many trucks his or her company operates, how many of these trucks take routes that cross the Detroit River, how many crossings per week these trucks make, the average length of trips made by company trucks, the types of good typically carried by company trucks, and the category of shipments typically handled by the company.

The survey concluded by providing the respondent with the opportunity to leave comments about the survey or the proposed new bridge. These comments are documented in Appendix L.

SURVEY ADMINISTRATION

Data collection began in April 2008 and concluded in June 2008. The survey collected data from travelers who had recently used one of the three existing crossings between Michigan and Ontario: the Ambassador Bridge, the Detroit-Windsor Tunnel and the Blue Water Bridge. Respondents were recruited using several different survey administration methods. Data were collected via:

1. Laptop-based administration of the survey to respondents intercepted at activity sites throughout the Detroit-Windsor area.
2. Online administration of the survey to travelers who were intercepted as part of a parallel origin-destination study conducted by IBI Group.
3. Email invitation to the survey for students and employees of institutions and businesses in Detroit and Windsor.
4. Email invitation to survey panel members residing in Michigan, adjoining U.S. states and in Ontario.
5. Telephone recruit and email invitation to commercial vehicle decision makers, such as fleet dispatchers and managers.

This multi-method sampling approach was used to reach a broad cross-section of the population with diverse demographic and trip characteristics. The data were tracked in real-time as survey administration progressed, and the sampling plan was adjusted as necessary to ensure a good mix of trip purposes, trip distances, and demographics.



AUTOMOBILE SURVEY ADMINISTRATION

Travelers who had made a trip within the past month that was at least 15 minutes long and used the Ambassador Bridge, the Detroit-Windsor Tunnel or the Blue Water Bridge were recruited to take the automobile survey.

A total of 848 respondents completed the automobile survey during April 2008 as outlined in Table 5.

Table 5: Automobile Survey – Respondent Source

Respondent Source	Complete Surveys
Intercept at Activity Sites	450
Origin-destination survey postcard	105
Area businesses and universities	93
Email invitation to online panel members	200
Total	848

Administration at Activity Sites

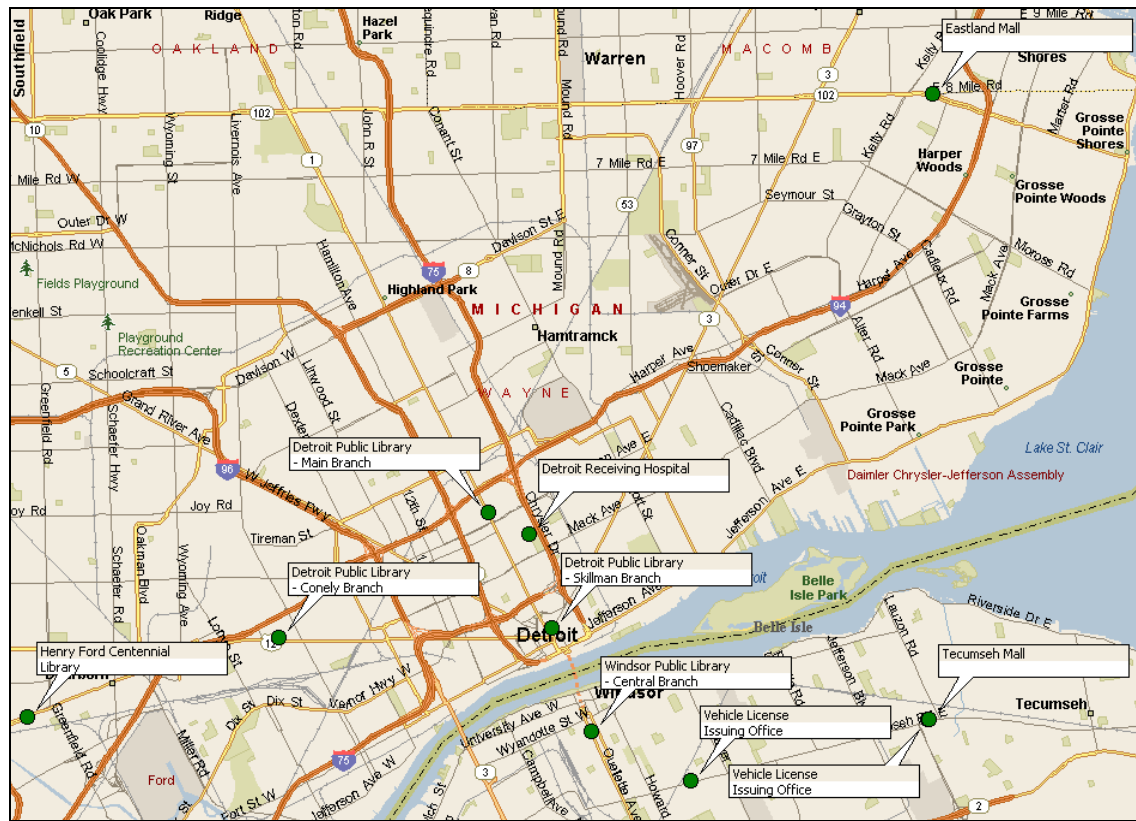
The survey questionnaire was administered at numerous activity sites throughout the Detroit-Windsor area over an eleven day period, from 5 April 2008 to 15 April 2008, with 450 respondents completing the survey (Table 6). The activity sites included locations in both Michigan and Ontario and were chosen to capture a diverse cross-section of the population to be intercepted in terms of both trip purposes and demographics (Figure 16). Sites with high pedestrian traffic and high incidence of people likely to meet the screening criteria were also targeted during the survey site selection.

Table 6: Automobile Survey – Complete Surveys by Intercept Location

Intercept Location	Number of Respondents
Michigan Sites	
Adair Rest Area	7
Detroit Public Library – Conely Branch	5
Detroit Public Library – Main Branch	111
Detroit Public Library – Skillman Branch	45
Detroit Receiving Hospital	10
Eastland Mall	30
Henry Ford Centennial Library	105
Ontario Sites	
Tecumseh Mall	16
Vehicle License Issuing Office (1)	20
Vehicle License Issuing Office (2)	46
Windsor Public Library - Central Branch	41
Other	14
Total	450



Figure 16: Automobile Survey – Intercept Locations Map



The intercept survey administration setup consisted of 10 to 20 laptop computer interview stations distributed across two to four locations each day. A framed poster mounted on an easel was positioned near the interview stations to help attract respondents. Each survey site was staffed by three attendants who were responsible for approaching and screening potential respondents, escorting the respondents to interview stations, and assisting respondents who had questions or who required computer assistance.

When taking the survey, respondents sat in front of a laptop computer and primarily used a mouse to record answers and navigate through the questionnaire. Most respondents completed the survey in 15 to 20 minutes. Data for each individual were automatically saved to the computer for later analysis. Respondents were generally enthusiastic about taking the survey and seemed to enjoy the survey’s interactive technology.

Origin-Destination Survey Administration

IBI Group conducted an origin-destination (OD) study in parallel to the stated preference study fieldwork. Data was collected, in part, by intercepting vehicles on the Canadian sides of the Ambassador Bridge, the Detroit-Windsor Tunnel, and the Blue Water Bridge. The origin-destination survey was administered to motorists along with a hand-out postcard with an invitation and



instructions for taking the stated preference survey online. The invitation postcard also included a unique password and the web link to the survey (Figure 17).

The OD survey was administered on April 15 at the Ambassador Bridge and the Detroit-Windsor Tunnel and on April 17 at the Blue Water Bridge. Data collection took place over a 24-hour period from midnight to midnight at each site with the exception of the Ambassador Bridge, where data were collected for two consecutive 24-hour periods. A total of 105 respondents completed the stated preference survey by this method from the approximately 7,500 postcards that were distributed by IBI Group.

Figure 17: Stated Preference Survey Invitation Postcard



Local Employee and Student Online Administration

Several area businesses and colleges were recruited to distribute invitations to their employees and students. In general, respondents were sent an email with an invitation and survey link from their employer. This Internet-based survey was exactly the same as the survey administered at activity sites. For Wayne State University, a description of the study and a link to the survey was included in the electronic campus newsletter (Figure 18).



Figure 18: Automobile Survey – Invitation in the Wayne State University Campus Newsletter



WSU - Business and Auxiliary Operations

470 Student Center
Detroit, MI 48202

Phone: (313) 577-2313
Fax: (313) 577-8686
www.busop.wayne.edu

Transportation Survey

Have you traveled between Michigan and Ontario at least once in the past month? Help improve your local transportation system by participating in a study to understand traffic patterns throughout the region. Please take a moment to complete a 15-minute survey regarding your travel preferences. Click on the following link to enter the survey:

<http://www.surveycafe.com/windsor/passwordw.asp>

A total of 93 students and employees at institutions and businesses in Detroit and Windsor completed the survey online.

Internet Survey Panel Online Administration

Additional respondents were recruited from Survey Sampling International (SSI), an online email sample provider. SSI emailed survey invitations to respondents residing in select counties in Michigan, Indiana, and Ohio, excluding Wayne County, MI, and select census metropolitan areas (CMAs) in Ontario, excluding the Windsor CMA. Potential respondents in the immediate Detroit-Windsor area were excluded from this email recruit so that more long-distance trips could be captured that had the potential of using all four crossings, including the Blue Water Bridge. A total of 200 respondents completed the survey as a result of this recruit.

COMMERCIAL VEHICLE DRIVER SURVEY ADMINISTRATION

The computer-based survey about commercial vehicle travel was administered through intercepts at several large truck stops and rest areas. Data collection for commercial vehicles was conducted concurrently with the automobile survey from 5 April 2008 to 15 April 2008. Commercial vehicle drivers who had made a trip within the past month that was at least 15 minutes long and used the Ambassador Bridge, the Detroit-Windsor Tunnel or the Blue Water Bridge were recruited. Only commercial drivers with at least some routing decision authority qualified for the survey.

Commercial vehicle drivers were intercepted at four large truck stops and one rest area strategically located north, south, east and west of the Detroit-Windsor area (Figure 19). The field sites were selected to ensure a high probability of intercepting drivers who make qualifying trips. All of the selected field sites had rest areas and gas bays for commercial vehicles so that drivers could be intercepted while waiting or resting.



Figure 19: Commercial Vehicle Driver Survey – Intercept Locations Map



The survey administration setup consisted of 10 to 15 laptop computer interview stations distributed across two to three locations each day. A framed poster mounted on an easel was positioned near the interview stations to help attract respondents. Each survey site was staffed by three attendants who were responsible for approaching and screening potential respondents, escorting the respondents to interview stations, and assisting respondents who had questions or who required computer assistance.

Past survey experience has shown that commercial vehicle drivers are a difficult population to survey and typically have very low response rates. To increase participation, a \$20 incentive was offered to each commercial vehicle respondent that completed the survey.

A total of 293 commercial vehicle drivers completed the survey during the 11-day administration period. Table 7 presents the number of complete surveys obtained at each intercept location



Table 7: Commercial Vehicle Driver Survey – Complete Surveys by Intercept Location

Intercept Location	Complete Surveys
Adair Rest Area (Adair, MI)	8
Detroit Truck Stop (Trenton, MI)	131
Flying J Travel Plaza (London, ON)	104
Pilot Travel Center (Dexter, MI)	36
Travel Centers of America (Dexter, MI)	14
Total	293

COMMERCIAL VEHICLE DECISION MAKER SURVEY ADMINISTRATION

The commercial vehicle decision maker survey was administered online via email invitation to employees of commercial vehicle companies that currently operate vehicles between Michigan and Ontario. A total of 122 respondents completed the commercial vehicle decision maker survey between 29 April and 23 May 2008.

The recruitment of commercial vehicle decision makers began by observing and recording the company name, location, and, if possible, telephone number of commercial vehicles crossing the Ambassador and Blue Water Bridges. Additionally, field administrators collected commercial vehicle information at the Pilot Travel Center and Travel Centers of America locations in Dexter, MI. This information was often readily visible on the exterior signage of a vehicle's cab or trailer. After obtaining this list of companies, telephone numbers were either verified or discovered using online directories. In total, the contact information for 1,067 commercial vehicle companies was collected.

AnswerNet, a call center, contacted these companies by phone and requested an employee's participation in the decision maker survey. Upon reaching an appropriate employee, either a dispatcher, manager, or someone responsible for routing, the call center representative would ask a series of screening questions over the phone to ensure the employee qualified for the decision maker survey. These questions included whether the employee's company makes trips between Michigan and Ontario and if the employee was indeed responsible for routing decisions. For those qualifying employees, the call center representative would then request permission to send an email invitation to participate in the decision maker survey. In the instance an employee was not responsible for routing, the call center representative would request the email addresses of those in the company who were responsible for routing decisions.

A total of 435 commercial vehicle decision maker email addresses were collected. An invitation email and up to two reminder emails were sent to each potential respondent. The emails provided a brief description of the study and included a direct link to the online survey. Of the 435 potential respondents contacted by email, 200 clicked on the link and 122 went on to complete the survey.



SURVEY RESULTS

The survey was designed to produce a generally representative sample of travelers who would potentially use the new bridge to cross the Detroit River. It is important to sample a sufficient range of travelers and trip types to support the statistical estimation of coefficients of a choice model. By collecting data from a range of traveler and trip types, it is possible to identify the ways in which different characteristics affect mode choice behavior. These differences can then be reflected in the structure and coefficients of the resulting choice model. The survey sample that supports choice model estimation does not need to perfectly match the existing population proportions as long as: (a) any behavioral differences are properly represented in the model and (b) the model is applied for forecasting using appropriate population proportions and/or sample weights.

AUTOMOBILE RESULTS




A total of 848 automobile drivers completed the survey during the spring of 2008. A majority of respondents (53%) completed the survey at various intercept sites throughout the greater Detroit-Windsor area in April 2008. The remaining 47% of respondents completed the survey online after receiving an invitation via email, postcard hand-out and/or online newsletter.

The descriptive analysis phase of this study was divided into three sections: trip characteristics, stated-preference debrief, and demographics. A complete set of data tabulations is represented in Appendix D.

Automobile Trip Characteristics

To begin the survey, respondents were asked if they had made a trip of at least 15 minutes in duration that used the Ambassador Bridge, the Detroit-Windsor Tunnel, or the Blue Water Bridge within the past month. The survey instructed respondents to select all crossings used on trips that fit these criteria. A majority of respondents reported using the Ambassador Bridge and the Detroit-Windsor Tunnel while only 13% of respondents reported using the Blue Water Bridge. Figure 20 illustrates the respondent distribution of crossings used.

Figure 20: Automobile Results – Crossings Used in the Past Month (Select All That Apply)

Crossing	Count	Percent	
Ambassador Bridge	518	61%	
Detroit-Windsor Tunnel	457	54%	
Blue Water Bridge	107	13%	
Total	848		

If multiple crossings were selected, respondents were asked which crossing was used on their most recent trip. Of the respondents who saw this question, 52% used the Ambassador Bridge on their most recent trip, 39% percent used the Detroit-Windsor Tunnel, and 9% used the Blue Water Bridge.

Respondents were assigned to a crossing based on the crossing they used for their most recent trip. The remainder of the survey asked them to report the details of the most recent trip using their



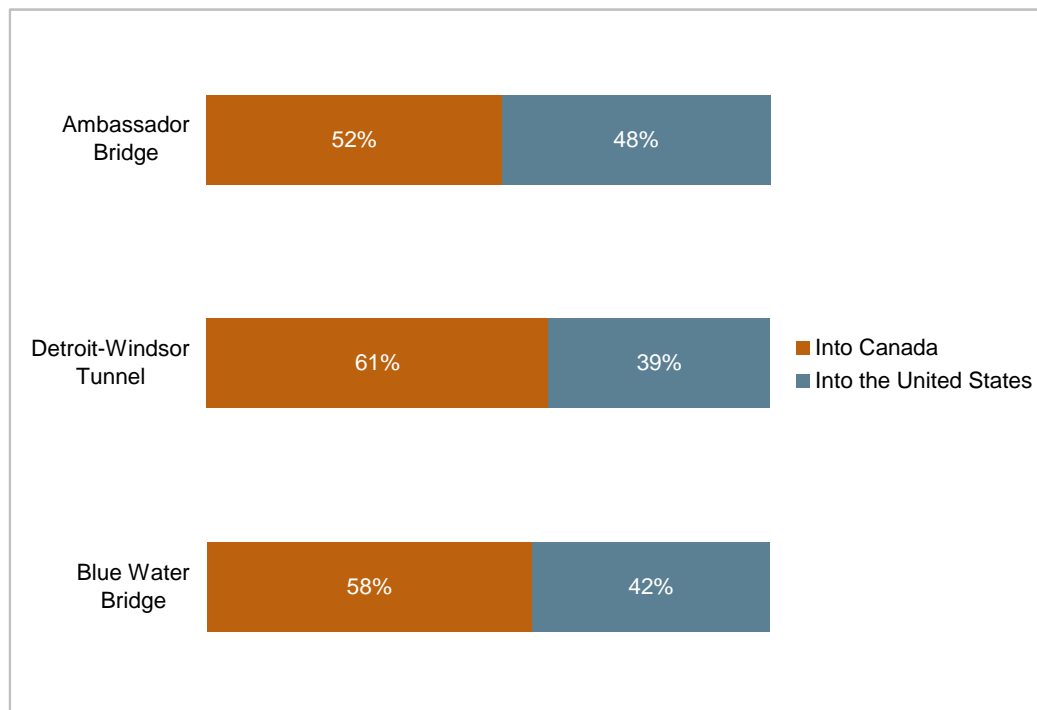
assigned crossing. The distribution of assigned crossings is shown in Figure 21. A little more than half the sample (51%) reported details about a trip using the Ambassador Bridge, 41% the Detroit-Windsor Tunnel, and 7% the Blue Water Bridge.

Figure 21: Automobile Results – Crossing Used on Reported Trip

Crossing	Count	Percent
Ambassador Bridge	433	51%
Detroit-Windsor Tunnel	351	41%
Blue Water Bridge	64	8%
Total	848	

Respondents reported the direction in which they were traveling on their trips. Trips using the Ambassador Bridge were evenly split in each direction, with 52% traveling into Canada, and 48% traveling into the United States. Sixty-one percent of Detroit-Windsor Tunnel respondents and 58% of Blue Water Bridge respondents were traveling into Canada (Figure 22).

Figure 22: Automobile Results – Trip Direction by Crossing



Respondents also reported their main reasons for using their respective crossings. For all three crossings, “more direct route” was the most commonly selected reason. Fifty-nine percent of Ambassador Bridge respondents, 44% of Detroit-Windsor Tunnel respondents, and 59% of Blue Water Bridge respondents indicated that this was the main reason they used their respective crossings on their trips. A higher proportion of both Detroit-Windsor Tunnel respondents (12%) and Blue Water Bridge respondents (16%) cited “less traffic congestion” compared to those who used the



Ambassador Bridge (6%). Table 8 shows the distribution of respondents' main reasons for selecting a crossing.

Table 8: Automobile Results – Bridge Purpose by Crossing

	Ambassador Bridge	Detroit-Windsor Tunnel	Blue Water Bridge	Total
More direct route	59%	44%	59%	53%
Less traffic congestion	6%	11%	16%	9%
Faster border processing times	9%	9%	5%	8%
Proximity to casinos	3%	12%	2%	7%
I don't like tunnels	9%	0%	2%	4%
Other amenities (duty free shops, etc.)	3%	3%	5%	3%
Less expensive than other alternatives	2%	2%	5%	2%
Followed road signs	2%	3%	0%	2%
Loyalty programs	2%	1%	0%	1%
Other	7%	15%	8%	10%
Total	433	351	64	848

Table 9 shows the distribution of respondents' trip purposes by crossing. Social or recreational trips were the most common for all three crossings. Work commute trips were second-most common among Ambassador Bridge respondents and described 18% of these respondents' trips. No work commute trips were reported for the Blue Water Bridge. This is expected, as Blue Water Bridge trips had to be fairly long distance to qualify for this survey.

Table 9: Automobile Results – Trip Purpose by Crossing

	Ambassador Bridge	Detroit-Windsor Tunnel	Blue Water Bridge	Total
Social or recreational	32%	37%	34%	34%
Shopping	13%	18%	17%	15%
Go to/from a casino	9%	18%	5%	12%
Go to/from work	18%	7%	0%	12%
Vacation	9%	9%	25%	10%
Work-related business	7%	4%	11%	6%
Go to/from Detroit Metro Airport	8%	2%	2%	5%
Other personal business	4%	4%	6%	4%
Go to/from school	1%	2%	0%	1%
Go to/from Windsor Airport	0%	1%	0%	0%
Total	433	351	64	848

Respondents reported the time at which they used their respective crossings. The crossing times were aggregated into four categories: AM peak (weekdays between 6:00 AM and 10:00 AM), PM peak



(weekdays between 3:00 PM and 7:00 PM), off-peak, and weekend. Table 10 shows the distribution of work and non-work trip purposes by time of day for the three crossings. Work trips include work commute and work-related business trip purposes, while non-work trips include all other purposes. For all crossings, the majority of work trips took place during the peak periods, while the majority non-work trips occurred during the off-peak and weekend periods.

Table 10: Automobile Results – Trip Purpose by Crossing by Time of Day

	Ambassador Bridge			Detroit-Windsor Tunnel			Blue Water Bridge		
	Work	Non-work	Total	Work	Non-work	Total	Work	Non-work	Total
AM Peak (6 - 10 AM)	46%	15%	22%	53%	10%	14%	43%	5%	9%
PM Peak (3 - 7 PM)	31%	14%	18%	11%	17%	16%	29%	14%	16%
Off-peak	16%	30%	26%	31%	35%	34%	14%	53%	48%
Weekend	7%	42%	33%	6%	38%	35%	14%	28%	27%
Total	109	324	433	36	315	351	7	57	64

An analysis of respondents' travel times by their crossing times reveals that trips that took 90 minutes or more were the most common across all four crossing time periods. However, trips that took 30 to 44 minutes were equally as common in the AM peak period. In general, the travel time distributions were similar for each time period with the exception of the off-peak period where trips of 90 minutes or more were much more common (Table 11).

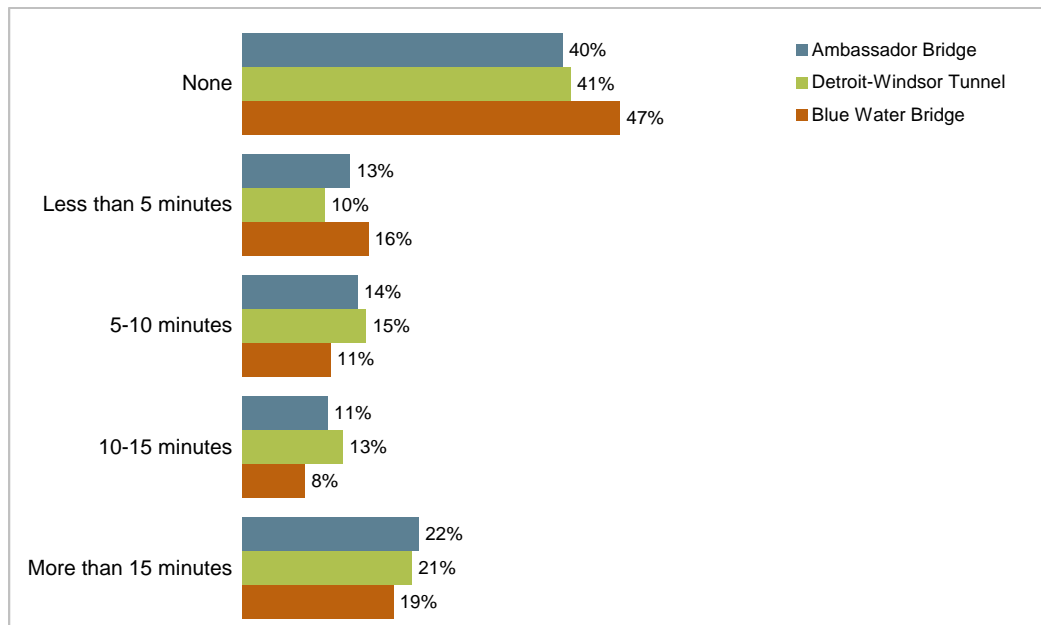
Table 11: Automobile Results – Travel Time by Crossing Time

	AM Peak	PM Peak	Off-peak	Weekend	Total
15 - 29 minutes	7%	17%	14%	14%	13%
30 - 44 minutes	21%	19%	12%	16%	16%
45 - 59 minutes	13%	16%	13%	12%	13%
60 - 74 minutes	18%	12%	14%	19%	16%
75 - 89 minutes	7%	3%	4%	5%	4%
90 minutes or more	35%	33%	42%	35%	37%
Total	153	145	266	284	848

Forty percent of Ambassador Bridge respondents, 41% of Detroit-Windsor Tunnel respondents, and 47% of Blue Water Bridge respondents reported no delay due to heavy traffic. Blue Water Bridge respondents were much more likely to have a delay of less than five minutes while Ambassador Bridge and Detroit-Windsor Tunnel respondents reported delays that were more than 15 minutes long with greater frequency. Figure 23 illustrates the distribution of delays due to heavy traffic by crossing.



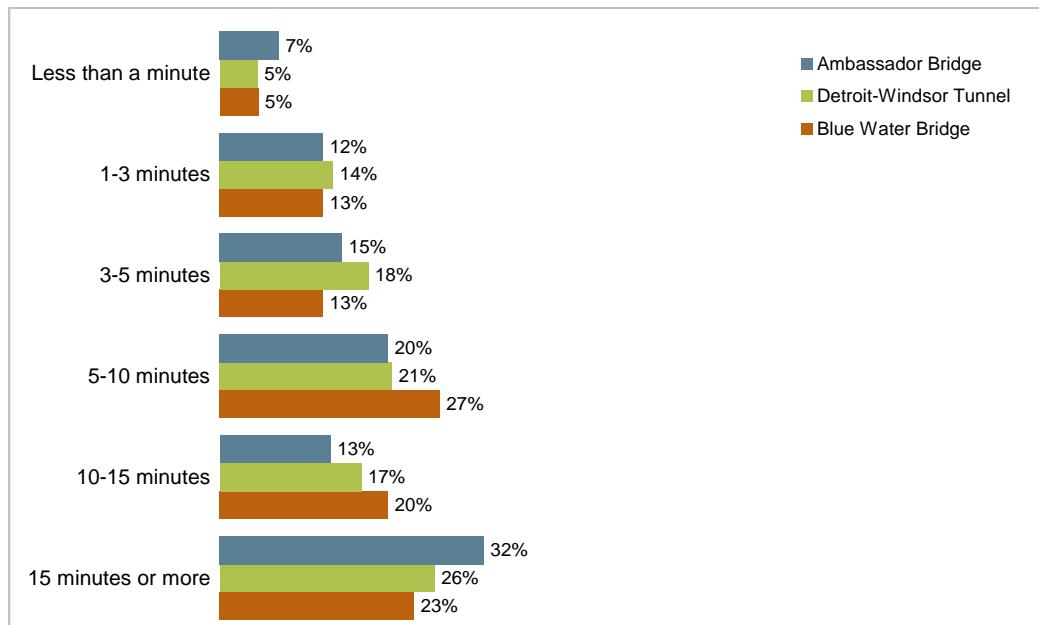
Figure 23: Automobile Results – Heavy Traffic Delay by Crossing



Respondents were also asked how long they spent in the queue at the border crossing. The most frequently reported time for both Ambassador Bridge and Detroit-Windsor Tunnel respondents was 15 minutes or more. Thirty-two percent of Ambassador Bridge respondents and 26% of Detroit-Windsor Tunnel respondents indicated they spent this amount of time at customs. Blue Water Bridge respondents were slightly less likely to spend 15 minutes or more at customs. The most frequently reported time for Blue Water Bridge respondents was five to ten minutes, which described 27% of respondents' trips in this segment (Figure 24).



Figure 24: Automobile Results – Time Spent in the Queue at the Border by Crossing

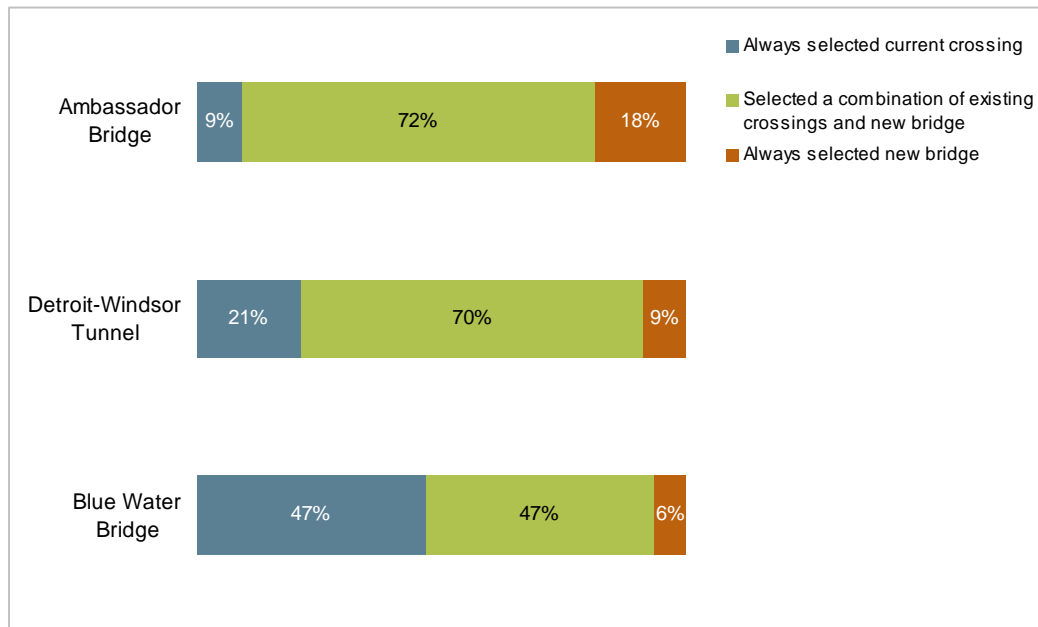


Automobile Stated Preference Debrief

Ambassador Bridge respondents were most likely to always select the new bridge option in the stated preference exercise compared to respondents who used the Detroit-Windsor Tunnel or Blue Water Bridge on their reported trips. Eighteen percent of Ambassador Bridge respondents always selected the new bridge whereas only 8% of Detroit-Windsor Tunnel respondents and 6% of Blue Water Bridge respondents did the same. Blue Water Bridge respondents always selected their current crossing, the Blue Water Bridge, with considerably greater frequency than respondents who used the Ambassador Bridge or Detroit-Windsor Tunnel on their reported trips. Forty-seven percent of Blue Water Bridge respondents always selected their current crossing in the stated preference exercise. This proportion was only 9% for Ambassador Bridge respondents and 22% for Detroit-Windsor Tunnel respondents (Figure 25).



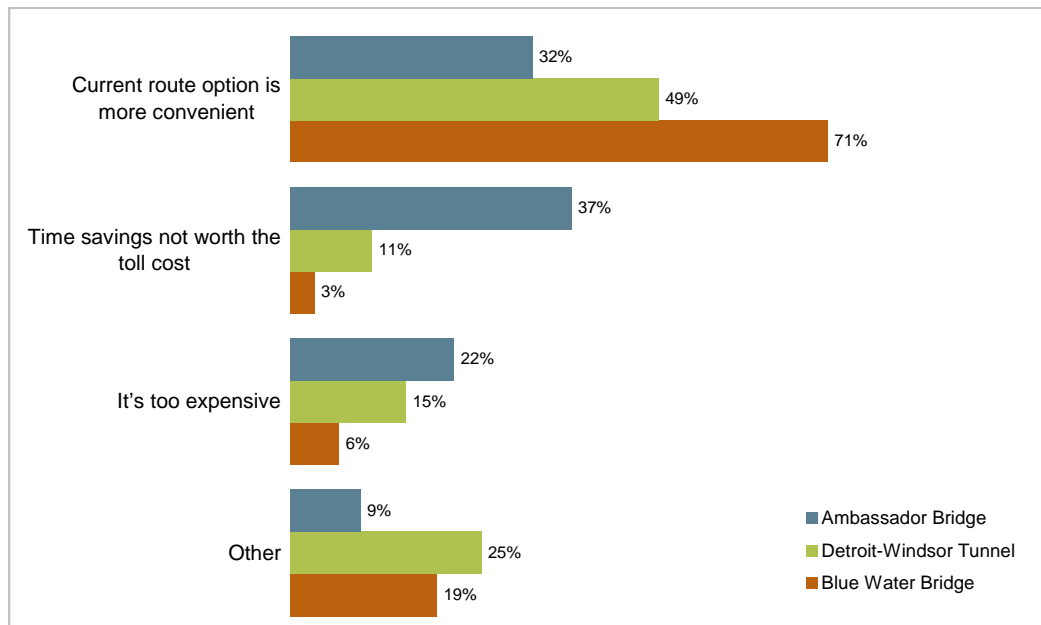
Figure 25: Automobile Results – Stated Preference Behavior by Crossing



Two hundred and thirty-nine respondents never selected the new bridge option in the stated preference exercise out of 848 total respondents. The distribution of respondents' primary reason for never selecting the new bridge option is shown in Figure 26. Half (49%) of Detroit-Windsor Tunnel respondents and almost three-fourths (71%) of Blue Water Bridge respondents cited the convenience of their current route as the main reason for their aversion to the new bridge option. Thirty-two percent of Ambassador Bridge respondents selected the convenience of their current route as the primary reason for never selecting the new bridge. Another 37% of Ambassador Bridge respondents chose a lack of time savings relative to toll cost to explain why they never chose the new bridge. Ambassador Bridge respondents were also the most likely to mention that the new bridge is too expensive (22%).



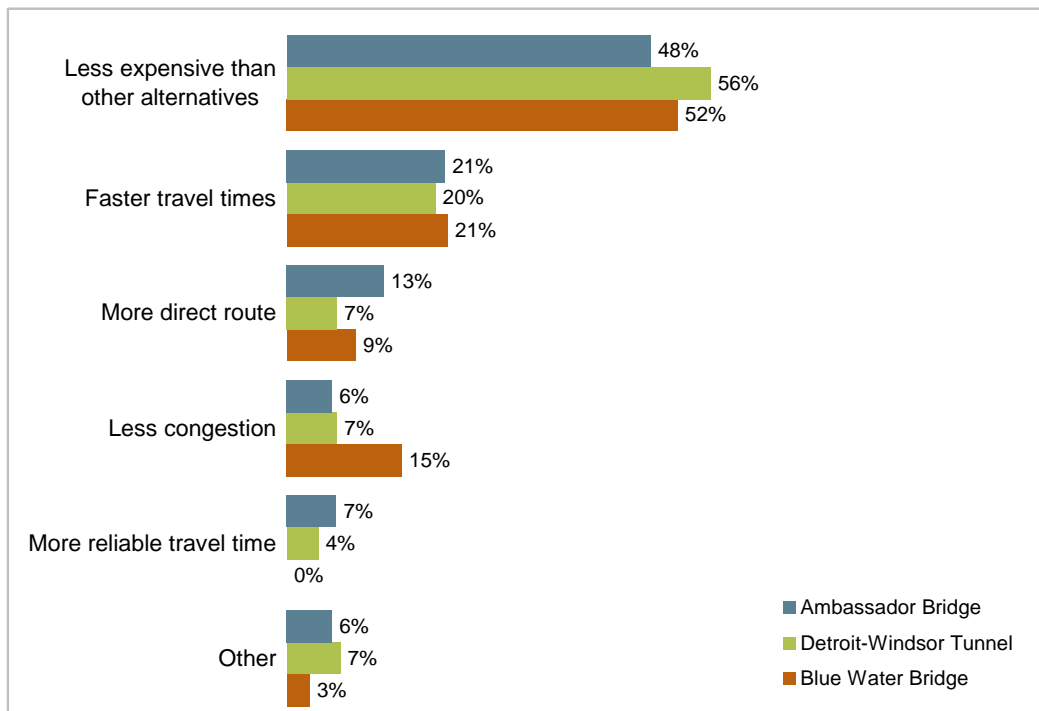
Figure 26: Automobile Results – Primary Reason for Never Selecting the New Bridge Option by Crossing



The remaining 609 respondents did select the new bridge option at least once in the stated preference exercise. For all three crossings, the most commonly cited reason for selecting the new bridge option was its lower cost compared to the other options. Forty-eight percent of Ambassador Bridge respondents, 56% of Detroit-Windsor Tunnel respondents, and 52% of Blue Water Bridge respondents reported this reason. Faster travel times were another commonly reported reason for selecting the new bridge option with 21% of Ambassador Bridge respondents, 20% of Detroit-Windsor Tunnel respondents, and 21% of Blue Water Bridge respondents selecting this option (Figure 27).



Figure 27: Automobile Results – Primary Reason for Selecting the New Bridge Option by Crossing

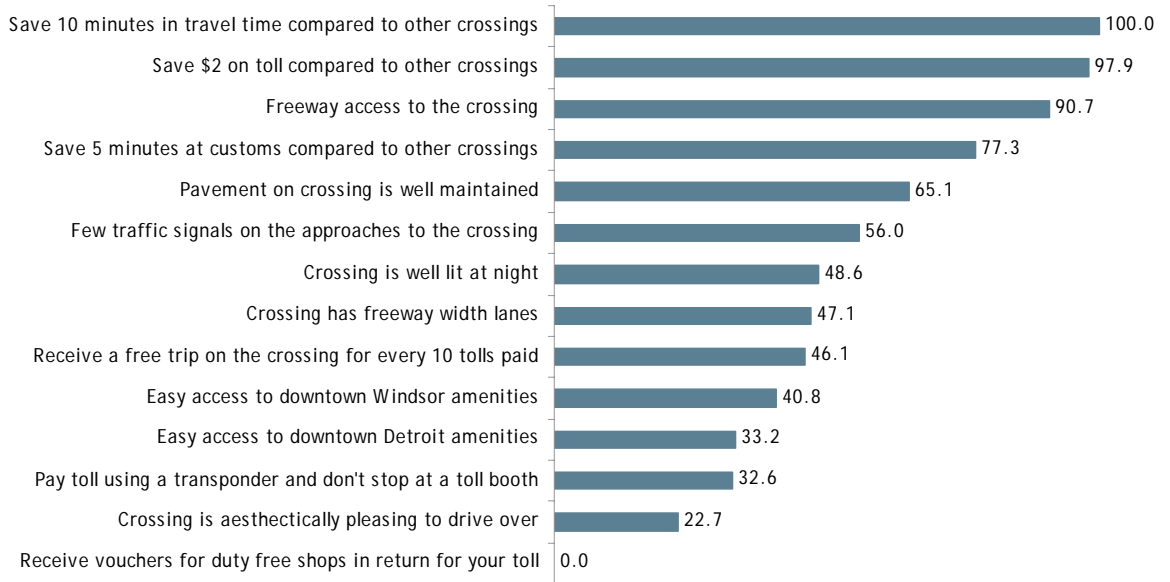


Automobile MaxDiff

The answers to MaxDiff tradeoff scenarios were compiled into a data set with seven records per respondent. Each record consisted of the four attributes presented in the experiment, as well as the attribute that was selected as the most important and the attribute that was selected as the least important. A statistical analysis was conducted to estimate a set of utilities for each attribute. These utilities can be used to compare the relative importance of each attribute. Figure 28 presents the results for the MaxDiff. The utilities have been scaled such that the least important attribute has a value of zero and the most important attribute has a value of 100.



Figure 28: Automobile Results – MaxDiff Scaled Utilities



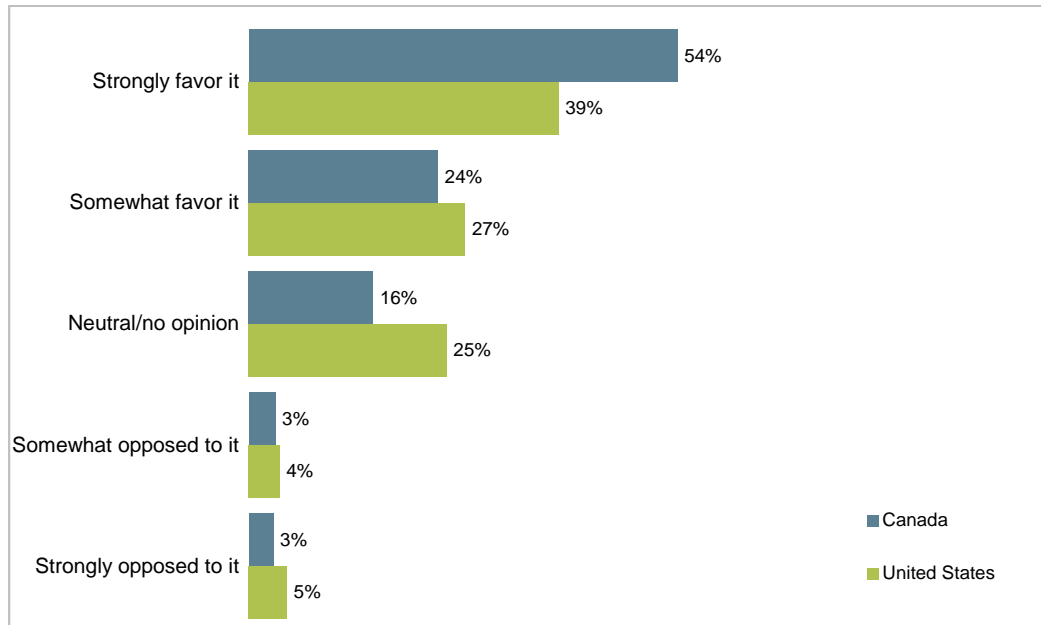
Automobile Opinion

Overall, automobile respondents heavily favored the new bridge. Seventy-two percent of respondents were somewhat or strongly in favor of the new bridge. Only 8% oppose the new bridge, while the remaining 20% neither favor nor oppose it.

Figure 29 shows respondents’ opinion of the new bridge by their country of residence. A majority of Canadians (54%) indicated they strongly favored the new bridge whereas only 39% of residents of the United States reported so. U.S. residents were more likely to somewhat favor or have no opinion of the new bridge.

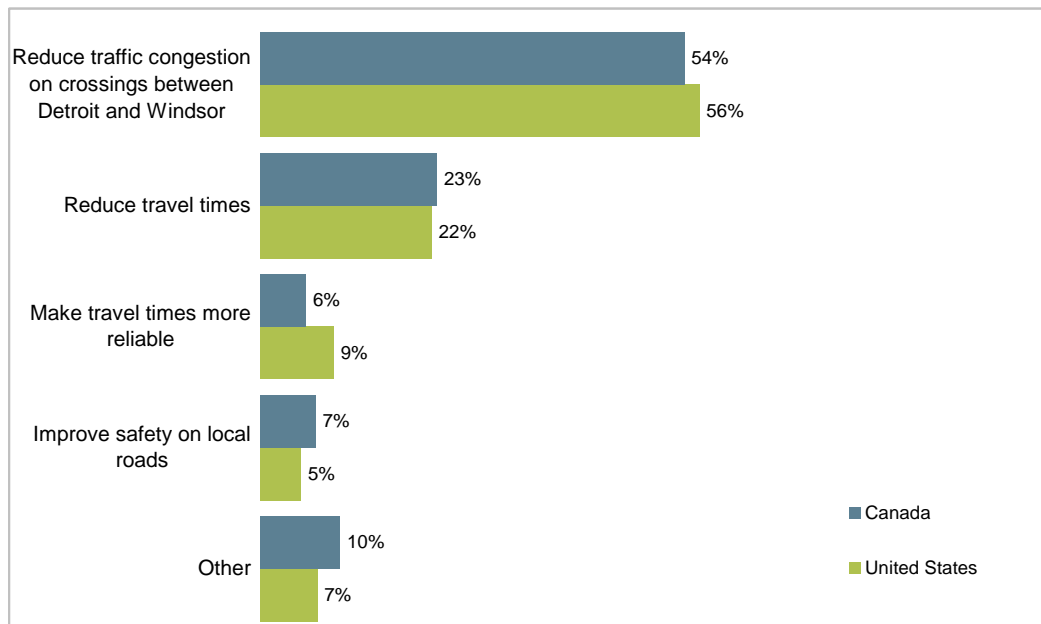


Figure 29: Automobile Results – Opinion of Proposed New Bridge by Country of Residence



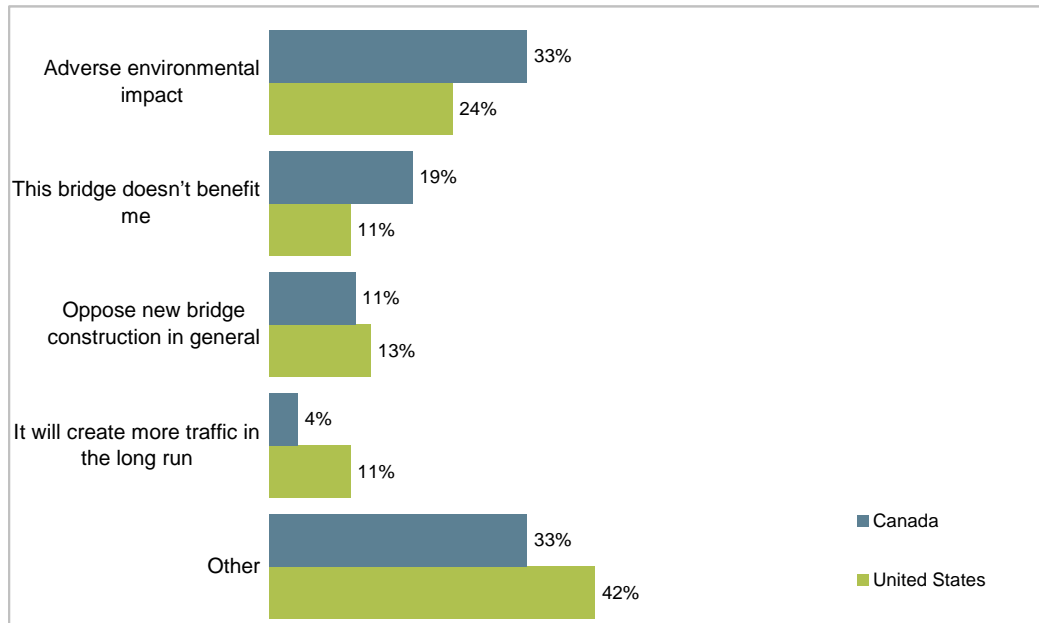
Of those who favor the new bridge, 54% of Canadian residents and 56% of U.S. residents said a reduction in traffic congestion was the primary reason for their favorable opinion. For residents of both countries, the second-most common reason for favoring the new bridge was reduced travel times. Twenty-three percent of Canadians and 22% Americans reported this reason (Figure 30).

Figure 30: Automobile Results – Primary Reason New Bridge Favored by Country of Residence



Of the respondents who opposed the new bridge, 33% of Canadians and 23% of Americans cited the environmental impact of the new bridge as their primary reason for opposition. As shown in Figure 31, residents of Canada were more likely to report that the new bridge would not benefit them compared to residents of the United States. Thirty-three percent of Canadian residents who opposed the new bridge and 41% of opposed U.S. residents specified a reason not listed in the survey.

Figure 31: Automobile Results – Primary Reason New Bridge Opposed by Country of Residence



Automobile Demographics

Slightly more than one-third (35%) of the sample reported a household size of two. Twenty-nine percent of respondents lived in a household with 4 or more people, 19% of respondents reported living alone and the remaining 17% percent of respondents live in a three-person household.

The most frequently reported number of household vehicles was two. Forty-three percent of respondents had two vehicles. Twenty-nine percent of respondents' households had one vehicle, while 24% had three or more and 4% did not have a household vehicle.

The male-to-female ratio was 53% to 47%. The most frequently reported age categories were 35 to 44 and 45 to 54 years old, which accounted for 23% and 25% of the sample respectively. Nineteen percent of respondents were 55 to 64 years old, and 16% were 25 to 34 years old.

A little over half (55%) of respondents were employed full-time while 16% were retired. Of those in the sample who were employed, 30% worked at jobs characterized as professional, technical and related. The next most common job type was executive, administrative, and managerial, which consisted of 13% of employed respondents.



Annual income was fairly evenly distributed across the sample. Twenty-three percent of respondents had household income between \$25,000 and \$49,999, and 19% of respondents had household incomes of \$50,000 to \$74,999. Under \$25,000, \$75,000 to \$99,999, and \$100,000 to \$149,999 consisted of 11%, 17%, and 15% of the sample respectively. The exchange rate at the time of the survey was at parity between the counties such that no adjustment to account for changes in exchange rates was necessary.

Figure 32: Automobile Results – Annual Household Income

Crossing	Count	Percent	
Under \$25,000	90	11%	
\$25,000 - \$49,999	194	23%	
\$50,000 - \$74,999	156	18%	
\$75,000 - \$99,999	141	17%	
\$100,000 - \$149,999	130	15%	
\$150,000 - \$199,999	39	5%	
\$200,000 or more	18	2%	
Total	848		

COMMERCIAL VEHICLE DRIVER RESULTS

A total of 293 commercial vehicle drivers completed the survey at various intercept sites throughout the Detroit-Windsor area. The descriptive analysis of the data presented in this section of the report is based on these 293 responses, and is summarized in three sections: recent trip characteristics, stated-preference debrief, and driver/company characteristics. A complete set of data tabulations is included in Appendix E.

Commercial Vehicle Driver Trip Characteristics

The survey for commercial vehicle drivers began with several questions about drivers' companies and their role within these companies. The most frequently reported company type was "trucking company with more than one vehicle," which accounted for 70% of the sample. Twenty-nine percent of drivers were "owner-operators" and either owned, leased, or made payments on the vehicles they drive.

When asked to specify driver type, 72% of respondents indicated that they work for one private carrier and 24% work for one or more for-hire carriers. The remaining 4% work for both private and for-hire carriers. In terms of decision-making authority, respondents were required to make at least some routing decisions to qualify for the survey. Sixty-six percent of drivers reported making all routing decisions, while 34% only make some routing decisions.

Like passenger vehicle drivers, drivers of commercial vehicles were asked to select all crossings that had been used within the past month to cross the Detroit River on a trip of at least 15 minutes in duration. Eighty-one percent of respondents reported using the Ambassador Bridge, and 35% reported using the Blue Water Bridge. Only 4% used the Detroit-Windsor Tunnel for a trip that met the required criteria (Figure 33).



Figure 33: Commercial Vehicle Driver Results – Crossings Used in the Past Month

Crossing	Count	Percent	
Ambassador Bridge	237	81%	
Detroit-Windsor Tunnel	11	4%	
Blue Water Bridge	104	35%	
Total	293		

Fifty-three respondents indicated making a qualifying trip on multiple crossings. The survey asked these individuals which crossing was used most recently. Seventy-two percent of these 53 respondents said the Ambassador Bridge was the crossing used on their most recent trip, while 26% said they used the Blue Water Bridge.

Figure 34 shows the distribution of crossings that respondents actually used on their reported trips. Three-fourths of respondents used the Ambassador Bridge on their reported trips, while 23% used the Blue Water Bridge. Throughout the remainder of this section of the report, these respondents will be referred to as Ambassador Bridge and Blue Water Bridge respondents respectively. Only 3 respondents (1%) discussed trips that used the Detroit-Windsor Tunnel. Because so few respondents used the Detroit-Windsor Tunnel, the sample for this segment was too small to warrant its own analysis and will not be included in any tabs that are segmented by facility.

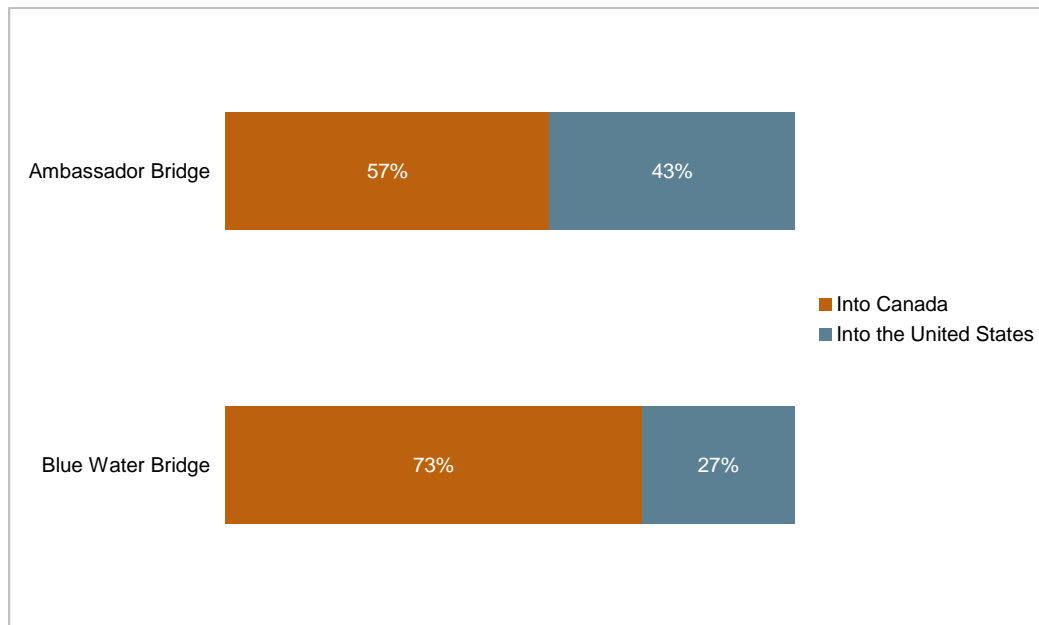
Figure 34: Commercial Vehicle Driver Results – Crossing Used on Reported Trip

Crossing	Count	Percent	
Ambassador Bridge	223	76%	
Detroit-Windsor Tunnel	3	1%	
Blue Water Bridge	67	23%	
Total	293		

Figure 35 shows the direction that respondents traveled on their reported trips broken out by crossing. Those using the Ambassador Bridge were split most evenly between those traveling into Canada (57%) and those traveling into the U.S. (43%). Approximately three-fourths of Blue Water Bridge respondents (73%) and two-thirds of Detroit-Windsor Tunnel respondents (67%) said they traveled into Canada on their reported trips.



Figure 35: Commercial Vehicle Driver Results – Trip Direction by Crossing



The next series of questions dealt with details about the drivers' vehicles. An overwhelming majority Ambassador Bridge respondents (82%) and Blue Water Bridge respondents (75%) reported driving a tractor with a trailer that had two axles (Figure 36).



Figure 36: Commercial Vehicle Driver Results – Vehicle and Trailer Type by Crossing

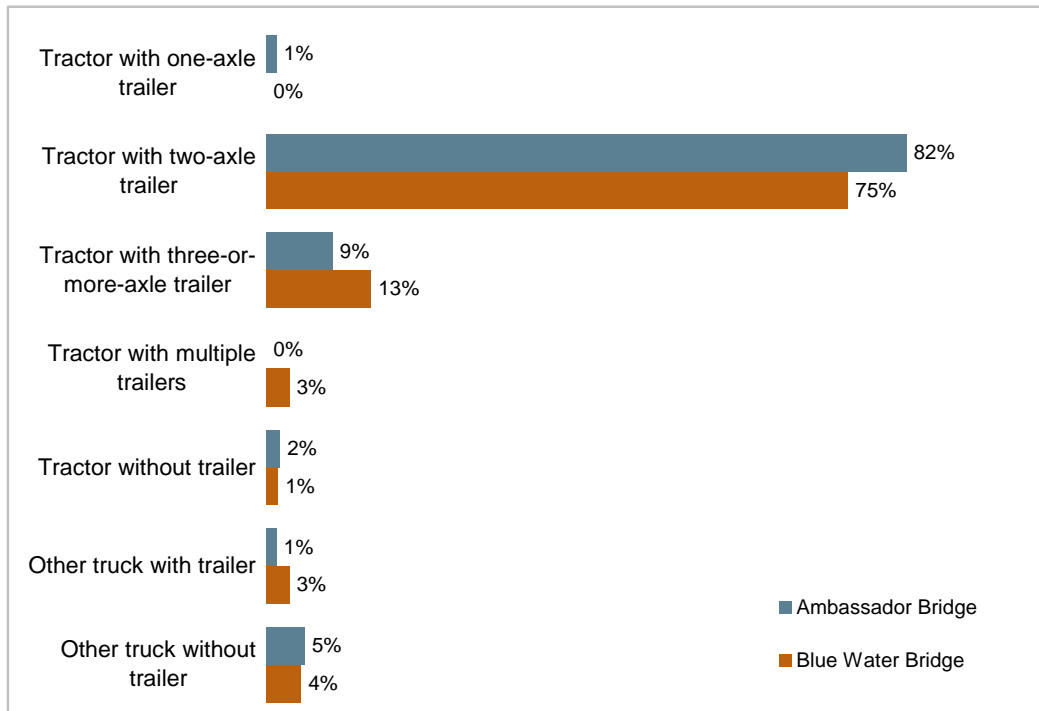
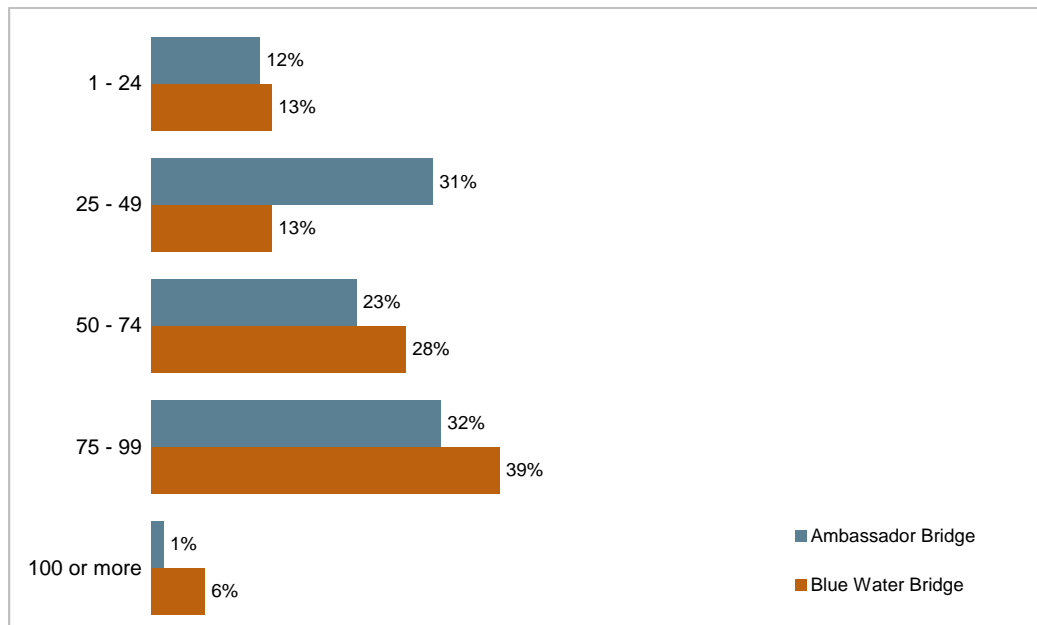


Figure 37 shows the distribution of gross vehicle weights segmented by crossing. On average, heavier trucks used the Blue Water Bridge compared to the Ambassador Bridge. Seventy-three percent of Blue Water Bridge commercial vehicles weighed over 50,000 pounds compared to only 56% of Ambassador Bridge trucks. Overall, vehicles weighing 75,000 to 99,999 pounds were most common for respondents using either the Ambassador Bridge or Blue Water Bridge. Thirty-nine percent of respondents using the Blue Water Bridge and 32% of Ambassador Bridge users drove a vehicle of this weight.



Figure 37: Commercial Vehicle Driver Results – Gross Vehicle Weight to the Nearest 1,000 lbs by Crossing



Respondents reported the primary reason they used their respective crossings on their most recent trip: 76% of respondents who used the Ambassador Bridge and 42% of respondents who used the Blue Water Bridge chose that crossing because it offered the most direct route. This was the most frequently reported reason for respondents using these crossings. Another 16% of Blue Water Bridge respondents selected “faster border processing times” while 19% gave a reason not specified in the predefined list (Table 12).

Table 12: Commercial Vehicle Driver Results – Bridge Purpose by Crossing

	Ambassador Bridge	Detroit-Windsor Tunnel	Blue Water Bridge	Total
More direct route	76%	33%	42%	68%
Faster border processing times	6%	33%	16%	9%
Followed road signs	5%	0%	1%	4%
Less expensive than other alternatives	0%	0%	13%	3%
Less traffic congestion	1%	33%	7%	3%
Loyalty programs	3%	0%	0%	2%
Proximity to casinos	0%	0%	0%	0%
Other	9%	0%	19%	11%
Total	223	3	67	293

An analysis of crossing time provided insight into what times of day respondents made their reported trips. Fifty percent of respondents completed their trips during the weekday off-peak period. Twenty



percent of trips occurred during the weekday AM peak period, and 20% were during the weekday PM peak period. The remaining 11% of trips took place on the weekend.

As shown in Table 13, trips of six or more hours were the most commonly reported across all crossing time periods except the weekday AM peak period. Thirty-nine percent of weekend trips, 29% of weekday off-peak period trips, and 27% of weekday PM peak period trips were six hours or more in duration. The shortest trips were represented by the AM peak period. Fifty-eight percent of these trips were made in less than three hours. For the other time periods, most trips were completed in over three hours.

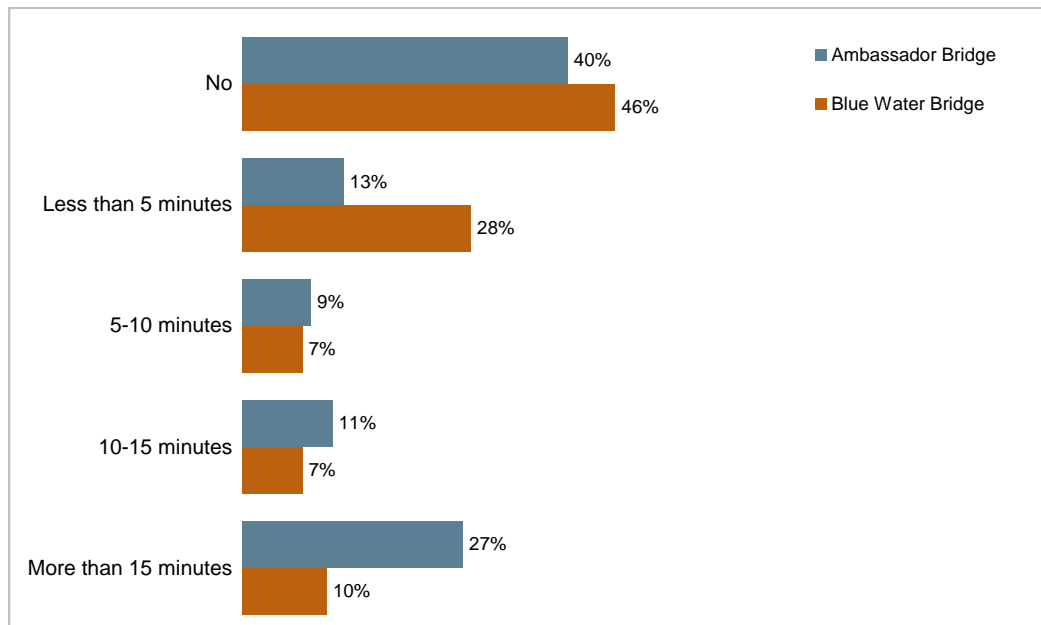
Table 13: Commercial Vehicle Driver Results – Travel Time by Crossing Time

	AM Peak	PM Peak	Off-peak	Weekend	Total
15 mins - 59 mins	26%	17%	14%	19%	17%
1 hr - 1 hr 59 mins	14%	14%	14%	0%	12%
2 hrs - 2 hrs 59 mins	18%	12%	12%	16%	14%
3 hrs - 3 hrs 59 mins	12%	9%	16%	10%	13%
4 hrs - 4 hrs 59 mins	5%	10%	10%	6%	9%
5 hrs - 5 hrs 59 mins	12%	10%	6%	10%	9%
6 hrs or more	12%	27%	29%	39%	26%
Total	57	58	147	31	293

Respondents proceeded to report how long they were delayed because of heavy traffic and how much time they spent in the queue at the border crossing. Forty percent of those who used the Ambassador Bridge on their reported trips and 46% of those who used the Blue Water Bridge experience no delay because of heavy traffic. If a heavy traffic delay was experienced, Blue Water Bridge respondents were more likely to have that delay last less than five minutes compared to Ambassador Bridge respondents. Conversely, Ambassador Bridge respondents were more likely to have a lengthier delay; 27% reported a delay of more than 15 minutes, while only 10% of Blue Water Bridge respondents reported such a long delay due to heavy traffic (Figure 38).



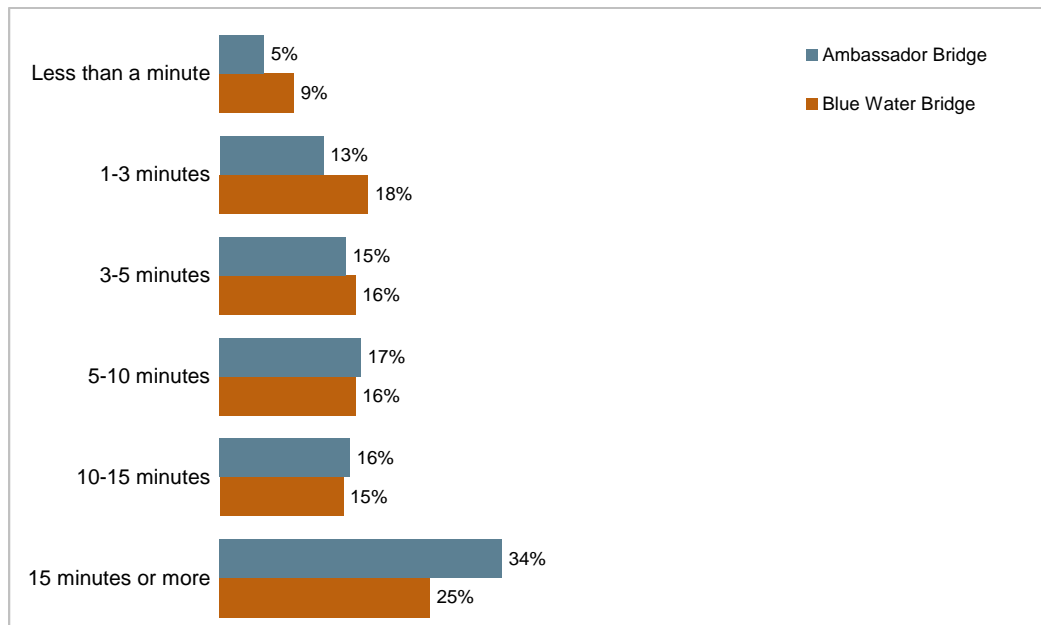
Figure 38: Commercial Vehicle Driver Results – Heavy Traffic Delay by Crossing



In terms of the amount of time spent in the queue at the border crossing, the distribution was similar for the Ambassador Bridge and Blue Water Bridge respondents. Figure 39 shows that the most frequently reported time spent at customs for both groups was 15 minutes or more. Thirty-four percent of respondents who used the Ambassador Bridge and 25% of respondents who used the Blue Water Bridge were waiting at the border crossing for this length of time.



Figure 39: Commercial Vehicle Driver Results – Time Spent in the Queue at the Border by Crossing

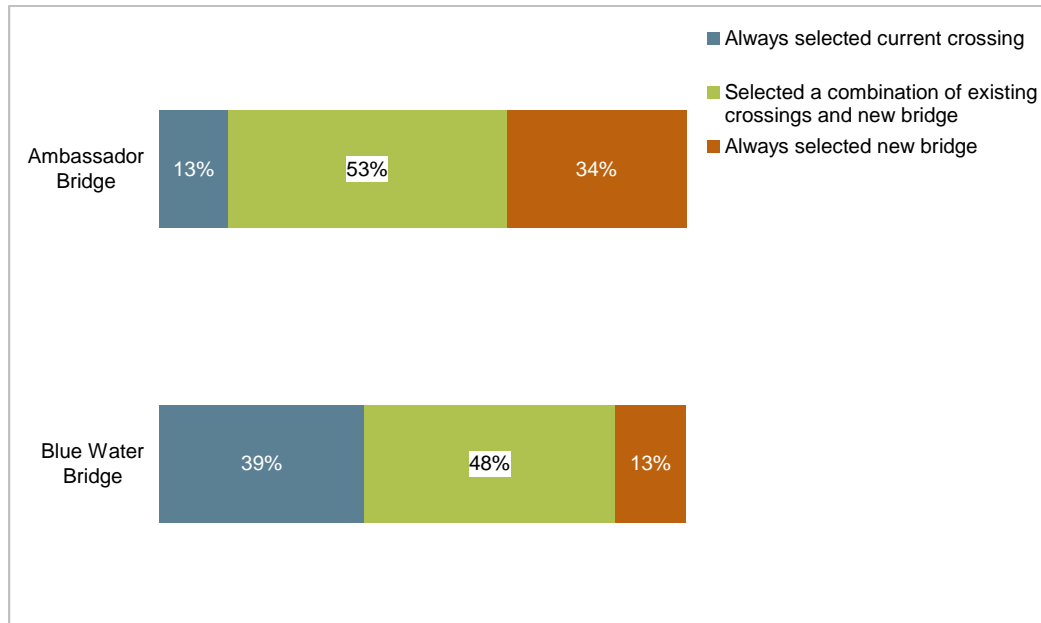


Commercial Vehicle Driver Stated Preference Debrief

The distribution of respondents’ behavior in the stated preference exercise broken out by crossing is shown in Figure 40. For those respondents who used the Ambassador Bridge, 13% exhibited an unwillingness to change their current behavior and selected the Ambassador Bridge every time. Thirty-four percent always selected the new bridge, and the remaining 53% selected a combination of the existing crossings and the new bridge. In comparison, Blue Water Bridge respondents expressed a stronger affinity for their current crossing with 39% selecting the Blue Water Bridge every time. Thirteen percent of respondents who used the Blue Water Bridge always selected the new bridge, and 48% selected a combination of the existing crossings and the new bridge.



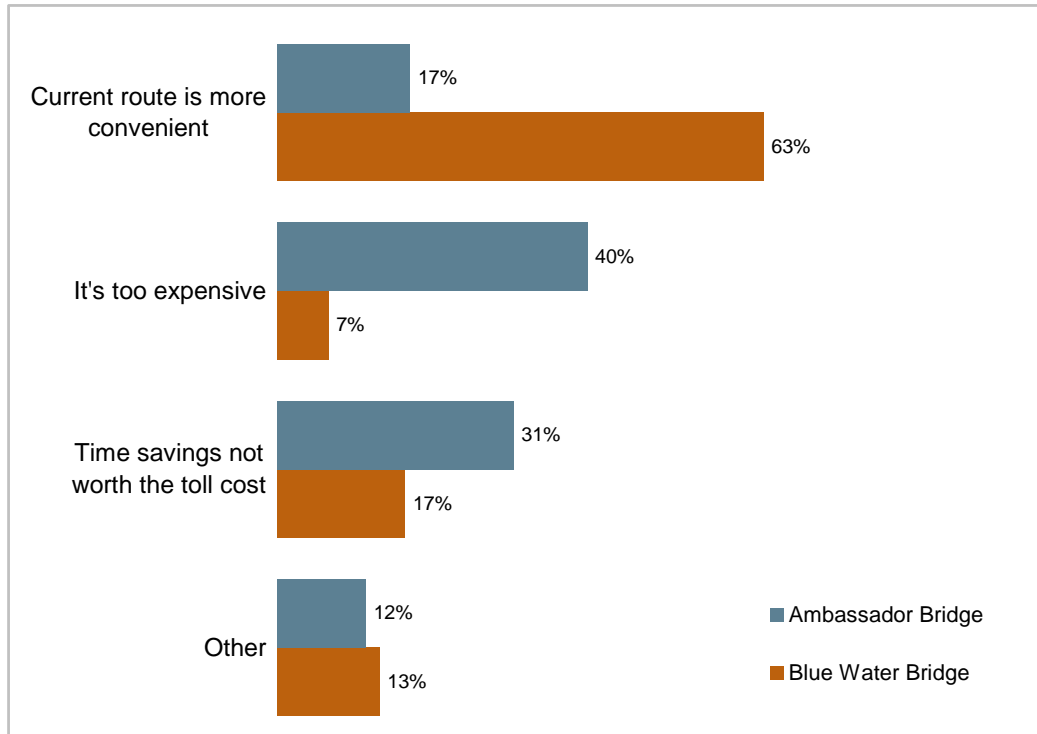
Figure 40: Commercial Vehicle Driver Results – Stated Preference Behavior by Crossing



A total of 83 respondents, 53 Ambassador and 30 Blue Water Bridge, never selected the new bridge option in the stated preference exercise. Sixty-three percent of Blue Water Bridge respondents never selected the new bridge because of the convenience of their current route. Seventeen percent of Blue Water Bridge respondents indicated a lack of time savings relative to cost as the primary reason they never selected the new bridge, and 13% reported “other” reasons. Only 19% of Ambassador Bridge respondents who never selected the new bridge cited the convenience of the current routes. Respondents in this segment were more likely to report high costs (40%) and a lack of time savings relative to cost (30%) as their primary reasons for never selecting the new bridge (Figure 41).



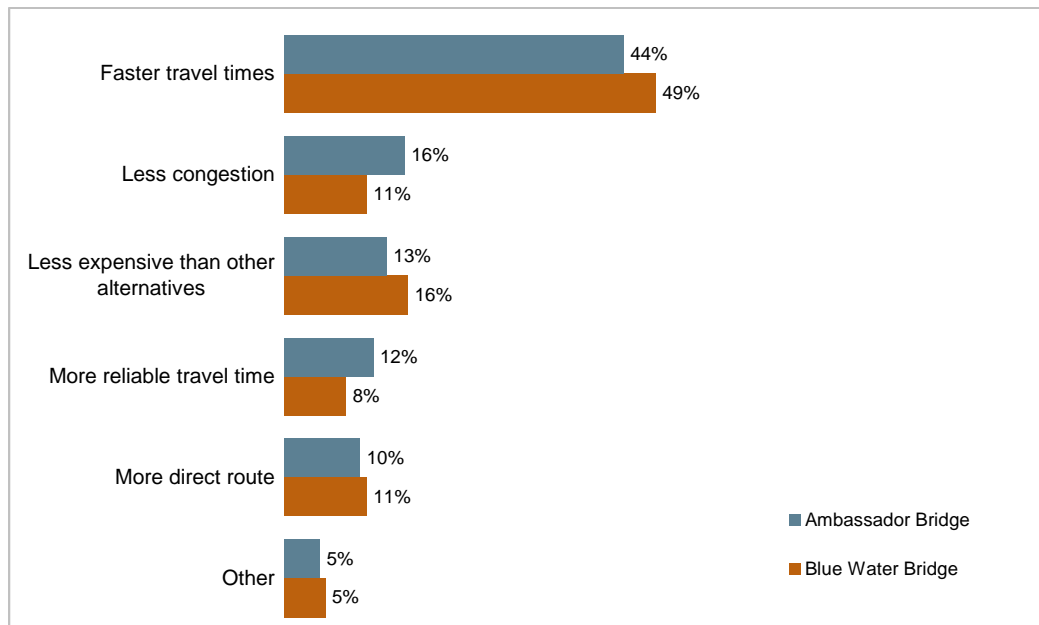
Figure 41: Commercial Vehicle Driver Results – Primary Reason for Never Selecting the New Bridge Option by Crossing



Two-hundred and ten respondents did select the new bridge option at least once in the stated preference exercise. Figure 42 shows the distribution of these respondents' primary reasons for doing so by crossing. Across both crossings, faster travel time was the most commonly reported reason for selecting the new bridge option. Forty-four percent of Ambassador Bridge respondents and 49% of Blue Water Bridge respondents chose this reason.



Figure 42: Commercial Vehicle Driver Results – Primary Reason for Selecting New Bridge by Crossing

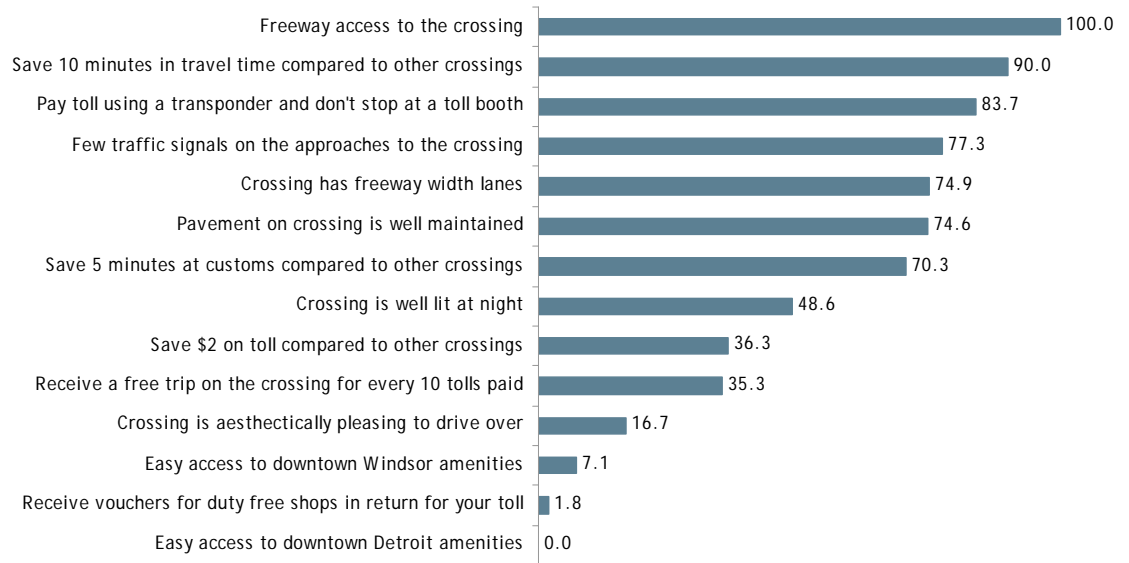


Commercial Vehicle Driver MaxDiff

The answers to MaxDiff tradeoff scenarios were compiled into a data set with seven records per respondent. Each record consisted of the four attributes presented in the experiment, as well as the attribute that was selected as the most important and the attribute that was selected as the least important. A statistical analysis was conducted to estimate a set of utilities for each attribute. These utilities can be used to compare the relative importance of each attribute. Figure 43 presents the results for the MaxDiff. The utilities have been scaled such that the least important attribute has a value of zero and the most important attribute has a value of 100.



Figure 43: Commercial Vehicle Driver Results – MaxDiff Scaled Utilities



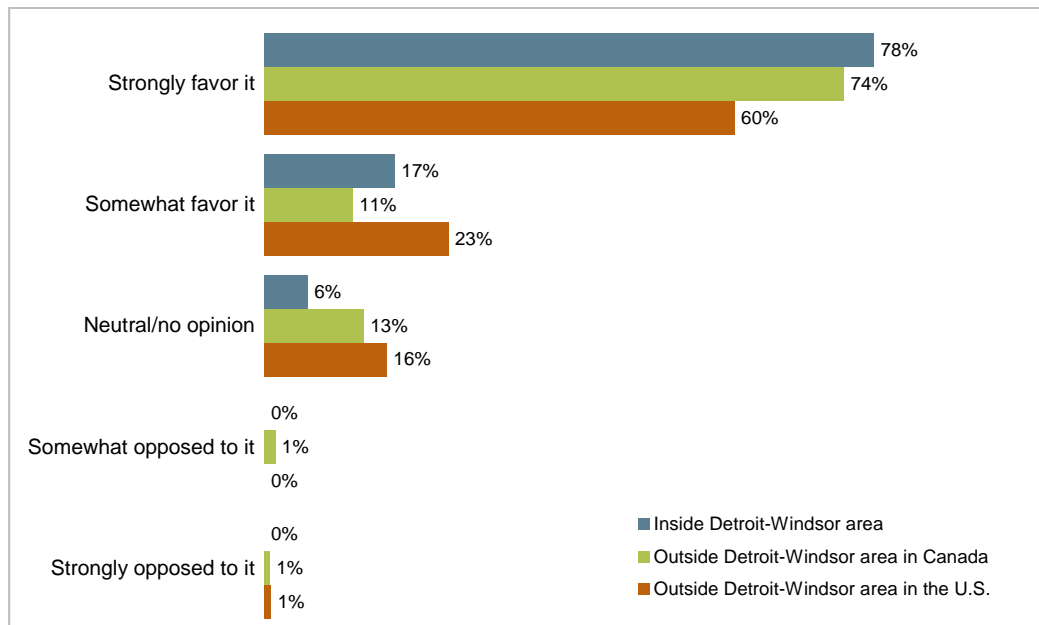
Commercial Vehicle Driver Opinion

The sample expressed overwhelming support for the new bridge. Eighty-five percent favor building the new bridge with 69% reporting that they strongly favor the initiative. Thirteen percent of respondents had a neutral opinion of the new bridge, and less than 2% opposed it.

Figure 44 shows the distribution of respondents’ opinions of the new bridge broken out by the location of respondents’ company headquarters. A higher proportion of respondents whose company headquarters’ are located inside the Detroit-Windsor area strongly favor the new bridge compared the respondents whose companies are based elsewhere in Canada and the U.S.



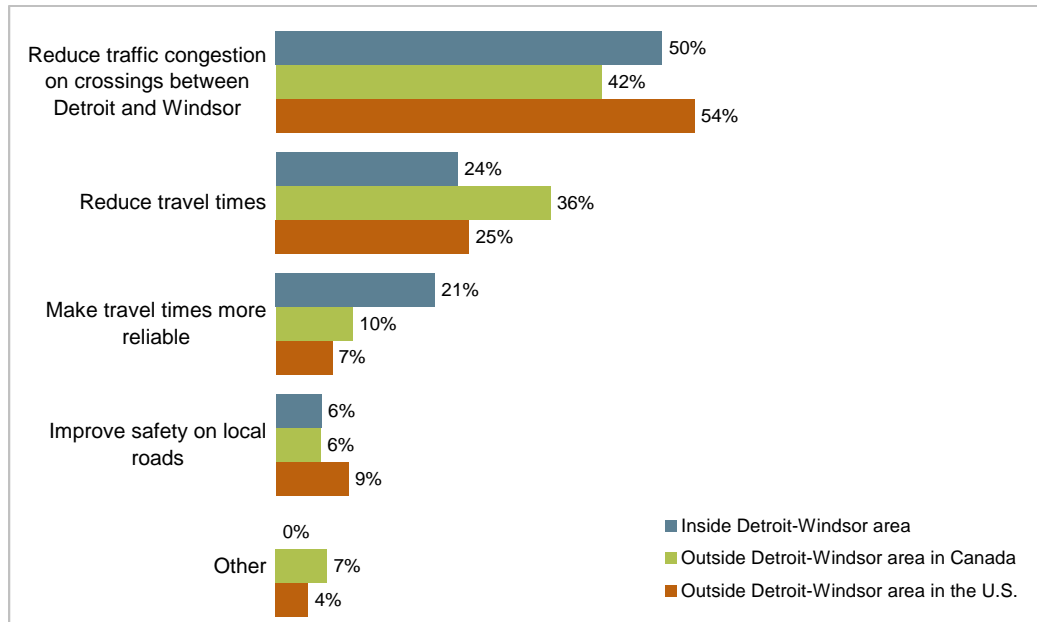
Figure 44: Commercial Vehicle Driver Results – Opinion of New Bridge by Company Headquarters Location



A reduction of traffic congestion on crossings between Detroit and Windsor was the most frequently reported reason that respondents favored the new bridge across company headquarter segments with 42% to 54% of respondents mentioning this reason. A reduction in travel times was another commonly reported reason for favoring the new bridge and was selected by approximately a quarter of respondents from companies based inside the Detroit-Windsor area and from U.S. companies outside this area. Thirty-six percent of respondents who favored the new bridge and work for Canadian companies outside the Detroit-Windsor chose reduced travel times (Figure 45).



Figure 45: Commercial Vehicle Driver Results – Primary Reason New Bridge Favored by Company Headquarters Location



Only four respondents expressed opposition to the new bridge. These respondents were asked their primary reason for opposition. Two of the four said that the primary reason they opposed the new bridge was because the bridge doesn't benefit them.

Demographics

In the last part of the survey, respondents reported the typical length of their trips and the type of goods and shipments typically transported. In terms of average trip length, 71% of respondents indicated their trips are usually long hauls that are in excess of 800 kilometers or 497 miles. Twenty-four percent of the respondents were medium hauls that are 301 to 800 km or 187 to 497 miles in length.

Miscellaneous items were the most frequently reported type of goods that the respondents typically carried and represented 39% of respondents. Other commonly reported type of goods categories were: other manufactured products equipment (37%), manufactured metal and mineral products (28%), food, alcohol, and tobacco products (20%), and forestry, wood, and paper products (19%).

Over three-fourths of respondents' shipments (83%) are a truckload, meaning they are shipments that weigh at least 4,536 kilograms or 10,000 pounds and do not require a terminal or break-bulk operation. Ten percent of respondents said their shipments were often less than a truckload. These are smaller shipments that weigh less than 45 kilograms or 100 pounds and entail terminal or break-bulk operation.



COMMERCIAL VEHICLE DECISION MAKER RESULTS

A total of 122 respondents completed the decision maker survey after receiving an email invitation. The descriptive analysis of the data based on these 122 responses is summarized in three sections: company role and trip characteristics, stated-preference debrief, and company demographics. Appendix F contains a complete set of data tabulations.




Commercial Vehicle Decision Maker Company Role and Trip Characteristics

The decision maker survey began with several questions about decision makers' companies and their role within these companies. Fifty-seven percent of respondents were managers or owners at their companies, making this the most frequently reported role. The other roles found in the sample were dispatcher (32%) and "other" (11%).

When asked to report the degree to which they are involved in routing at their companies, fifty-five percent of respondents said they make some routing decisions. The remaining 45% of respondents make all routing decisions.

Like the automobile and commercial vehicle driver surveys, the decision maker survey asked respondents to identify all crossings that their drivers had used in the past month. Almost all respondents (96%) said one or more of their drivers had used the Ambassador Bridge. Approximately three-fourths (78%) of respondents said their drivers had used the Blue Water Bridge; only 15% indicated their drivers had used the Detroit-Windsor Tunnel within the past month (Figure 46).

Figure 46: Commercial Vehicle Decision Maker Results – Crossing Used in the Past Month

Crossing	Count	Percent	
Ambassador Bridge	117	96%	
Detroit-Windsor Tunnel	18	15%	
Blue Water Bridge	95	78%	
Total	122		

Sixteen respondents indicated their drivers had used more than one crossing within the past month. For these respondents, the survey selected one of the three crossings at random and asked the respondent to complete the survey thinking about the trips their drivers make on the assigned crossing.

Figure 47 shows the distribution of crossings respondents referenced when reporting a typical trip made by their drivers. Fifty-five percent of respondents described a trip that used the Ambassador Bridge, and 39% reported trips that used the Blue Water Bridge. Throughout the remainder of this section of the report, these respondents will be referred to as Ambassador Bridge and Blue Water Bridge respondents respectively. Only 8 respondents (7%) discussed trips that used the Detroit-Windsor Tunnel. Because so few respondents indicated their drivers had used the Detroit-Windsor Tunnel, the sample for this segment was too small to warrant its own analysis and will not be included in any tabs that are segmented by facility.



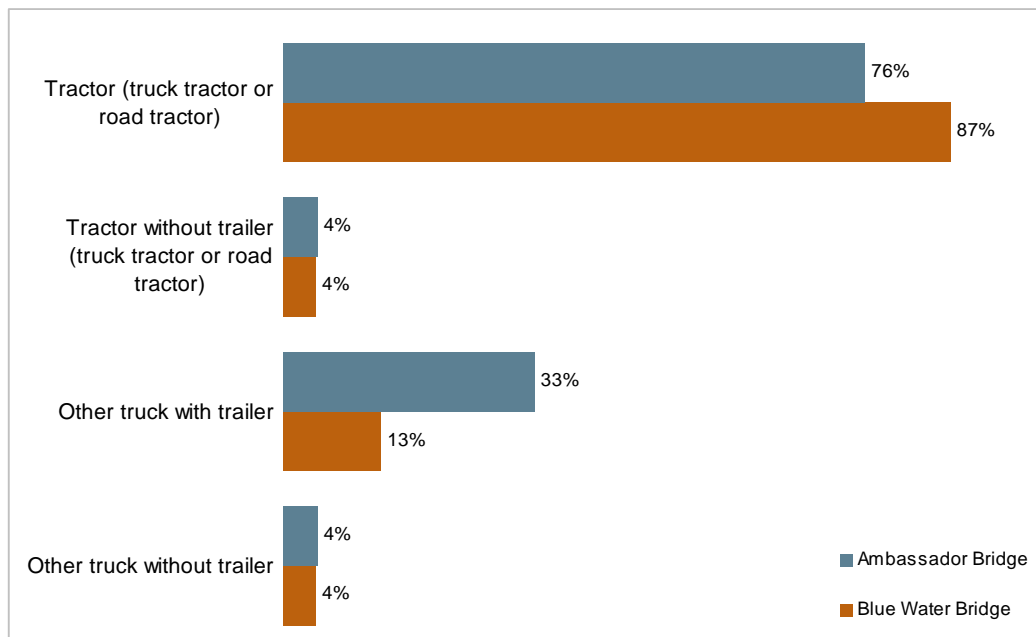
Figure 47: Commercial Vehicle Decision Maker Results – Crossing Used on Reported Trip

Crossing	Count	Percent
Ambassador Bridge	67	55%
Detroit-Windsor Tunnel	8	7%
Blue Water Bridge	47	39%
Total	122	100%

An analysis of direction traveled by crossing reveals that almost all drivers use all crossings to travel in both directions. Ninety-three percent of Ambassador Bridge respondents reported their drivers use this crossing traveling both to and from Canada. The remaining 7% of respondents said their drivers use the Ambassador Bridge only when traveling into Canada. Similarly, 98% of Blue Water Bridge respondents said their drivers make trips using this crossing in both directions. Interestingly however, the remaining 2% of respondents said their drivers use this crossing only when traveling into the United States.

The survey proceeded to ask respondents the different types of vehicles their drivers drive when using these crossings. For both Ambassador Bridge and Blue Water Bridge respondents, a tractor with a trailer was the most frequently reported vehicle type. Seventy-six percent of Ambassador Bridge respondents and 87% of Blue Water Bridge respondents said their drivers use a tractor trailer when using these crossings. Other truck types with a trailer was the second-most common vehicle type across both segments, accounting for 33% of Ambassador Bridge respondents' vehicles and 13% of Blue Water Bridge respondents' vehicles. Tractors without a trailer and other truck types without a trailer each accounted for less than 5% of vehicle types in both segments (Figure 48).

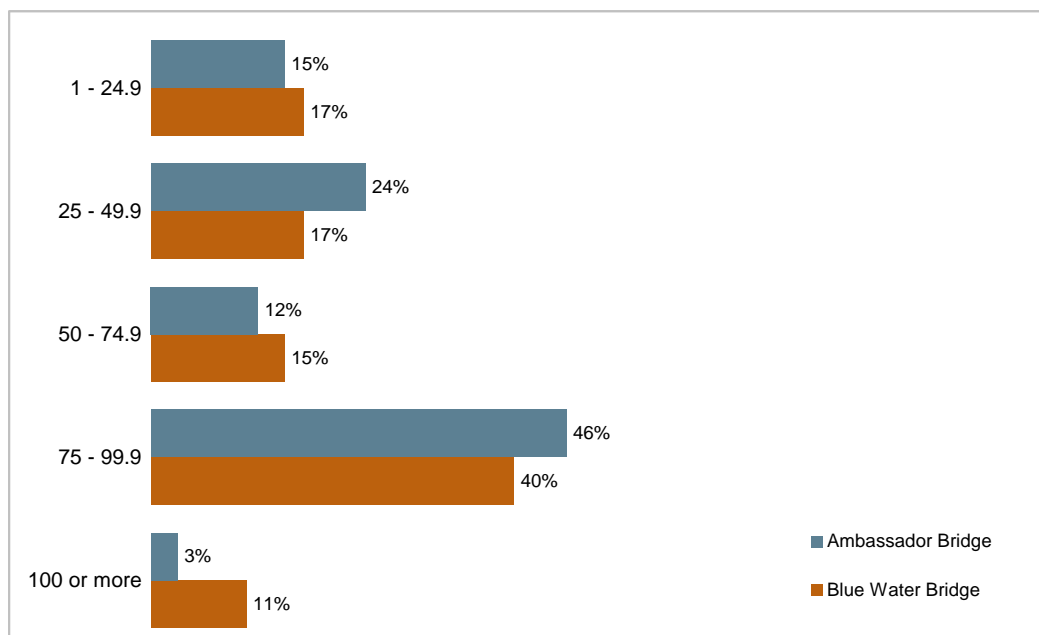
Figure 48: Commercial Vehicle Decision Maker Results – Vehicle Type by Crossing



Sixty-five Ambassador Bridge respondents and 46 Blue Water Bridge respondents said their drivers haul trailers when using these crossings. For these respondents, a single trailer truck with a two-axle trailer was the most common trailer used by their drivers. Of those respondents who indicated their drivers haul trailers, 89% of Ambassador Bridge respondents and 85% of Blue Water Bridge respondents reported a trailer this size. Seventeen percent of Ambassador Bridge respondents and 26% of Blue Water Bridge respondents said their drivers use a single trailer truck whose trailer has three or more axles.

Figure 49 shows the distribution of vehicle weights on the different crossings. For both the Ambassador Bridge and Blue Water Bridge, vehicles weighing 75 to 99.9 thousand pounds were the most frequently reported. Respondents reported that 46% of drivers using the Ambassador Bridge and 40% of drivers using the Blue Water Bridge had vehicles within this weight range. Ambassador Bridge respondents were considerably more likely to report vehicles weighing 25 to 49.9 thousand pounds, while Blue Water Bridge respondents reported vehicle weights of 100 thousand pounds or more with much greater frequency.

Figure 49: Commercial Vehicle Decision Maker Results – Vehicle Weight to the Nearest 1,000 lbs by Crossing



Respondents reported the primary reason their drivers typically use a particular crossing. Across the entire sample, “more direct route” was the most frequently reported reason drivers use a certain crossing. This also was the most commonly cited reason within the Ambassador Bridge and Blue Water Bridge segments, accounting for 69% and 43% of the reasons for using these crossings respectively. Blue Water Bridge respondents were more likely to cite “faster border processing times” and “less traffic congestion” as the primary reason their drivers used this crossing. Whereas 21% and 17% of Blue Water Bridge respondents reported “faster border processing times” and “less traffic congestion” respectively, only 13% and 1% of Ambassador Bridge respondents did so (Table 14).



Table 14: Commercial Vehicle Decision Maker Results – Bridge Purpose by Crossing

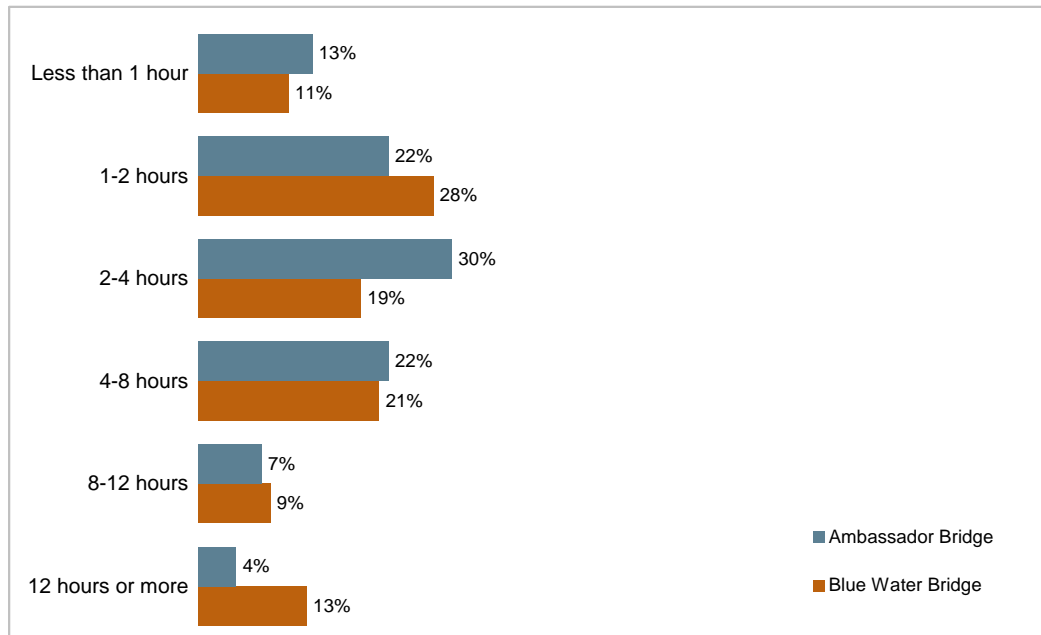
	Ambassador Bridge	Detroit- Windsor Tunnel	Blue Water Bridge	Total
More direct route	69%	25%	43%	56%
Faster border processing times	13%	25%	21%	17%
Less traffic congestion	1%	38%	17%	10%
Less expensive than other alternatives	0%	13%	6%	3%
Followed road signs	6%	0%	0%	3%
Don't like tunnels	1%	0%	0%	1%
Other	9%	0%	13%	10%
Total	67	8	47	122

Respondents were asked what days their drivers usually make their trips. Seventy-three percent of Ambassador Bridge respondents and 72% of Blue Water Bridge respondents reported that their drivers make trips on both weekdays and weekends. Approximately a quarter of each segment said their drivers typically make their trips only on weekdays.

An analysis of respondents' drivers' typical travel times reveals a fairly even distribution of travel times. Ambassador Bridge respondents most frequently cited a travel time of two to four hours, which consisted of 30% of this segment's reported travel times. However, travel times of one to two hours and four to eight hours also accounted for 22% of Ambassador Bridge respondents' travel times. For Blue Water Bridge respondents, 28% reported a travel time of one to two hours; 21% reported trips of four to eight hours; and 19% reported trips lasting two to four hours. Figure 50 illustrates the distribution of reported travel times across the two segments.



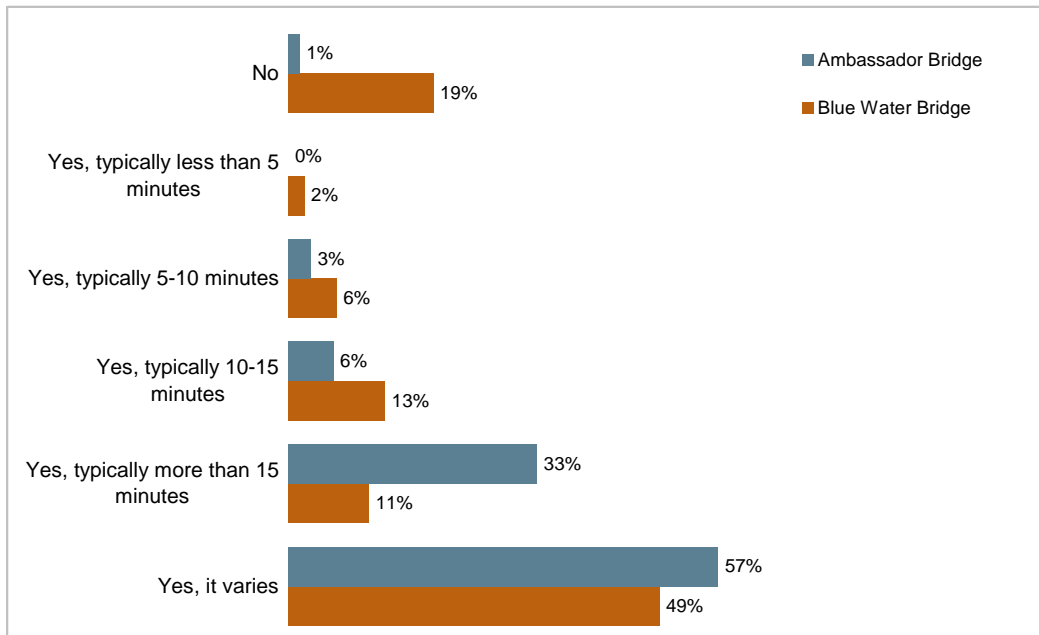
Figure 50: Commercial Vehicle Decision Maker Results – Travel Time by Crossing



Respondents proceeded to report how long their drivers were delayed because of heavy traffic. Only one percent of Ambassador Bridge respondents’ drivers typically experience no delay due to heavy traffic. A far greater percentage of Blue Water Bridge respondents (19%) said their drivers typically experience no heavy traffic delays. Ambassador Bridge respondents were most likely to report a heavy traffic delay in excess of 15 minutes. Thirty-three percent of respondents in this segment said their drivers typically experience a delay this long due to heavy traffic. For both the Ambassador Bridge and Blue Water Bridge segments, respondents were most likely to report heavy traffic delays that typically vary in length (Figure 51).



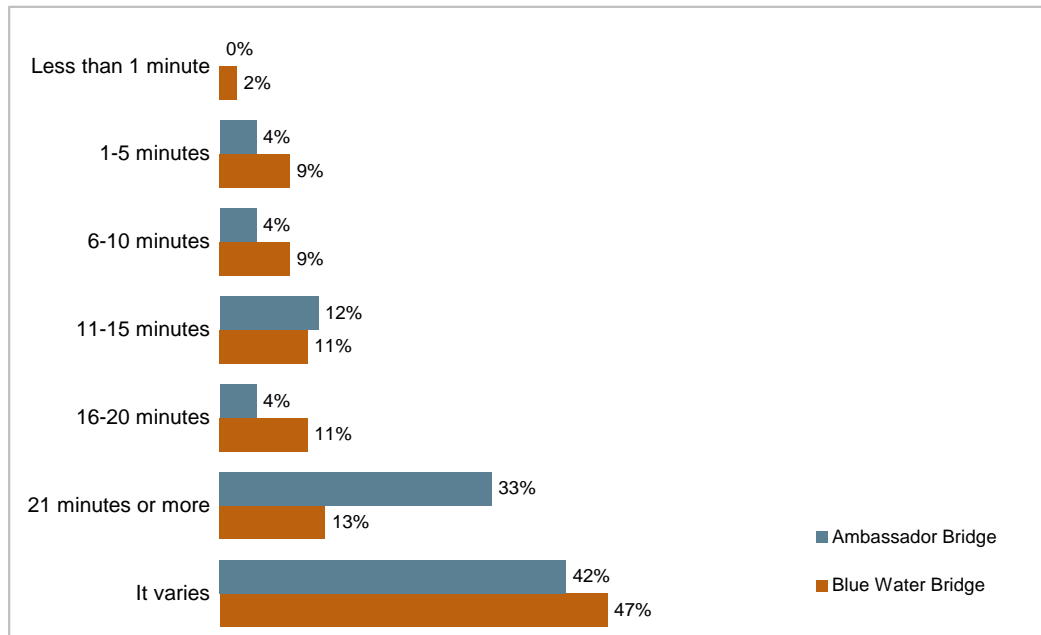
Figure 51: Commercial Vehicle Decision Maker Results – Heavy Traffic Delay by Crossing



When asked how much time their drivers typically spend in the queue at the border, both Ambassador Bridge and Blue Water Bridge respondents cited times that varied in length with the greatest frequency. Forty-two percent of Ambassador Bridge respondents and 47% of Blue Water Bridge respondents said the time their drivers spend at the border varies. Ambassador Bridge respondents (33%) were much more likely to say their drivers spent 21 minutes or more at the border compared to Blue Water Bridge respondents (13%). Figure 52 shows the distribution of time spent in the queue at the border for both crossings.



Figure 52: Commercial Vehicle Decision Maker Results – Time Spent in the Queue at the Border by Crossing

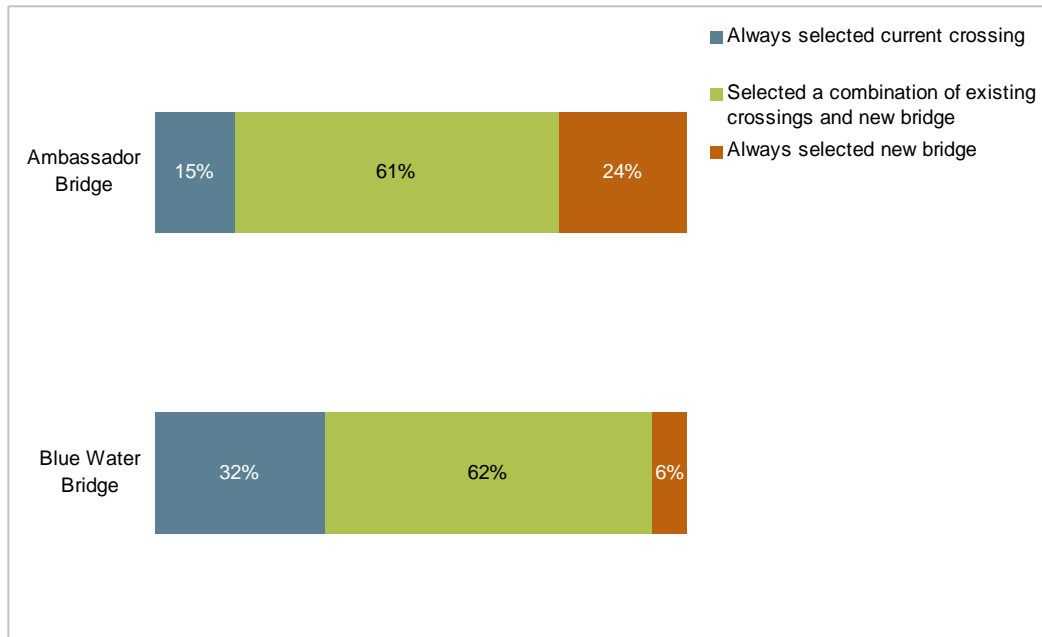


Commercial Vehicle Decision Maker Stated Preference Questions and Debrief

Respondents’ behavior in the stated preference exercise is shown segmented by crossing in Figure 53. For Ambassador Bridge respondents, 15% indicated they would not change which crossing they would instruct their drivers to use and selected the Ambassador Bridge every time. Almost a quarter (24%) of Ambassador Bridge respondents always selected the new bridge option, while the remaining 61% selected a combination of the existing crossings and the new bridge. In comparison, Blue Water Bridge respondents exhibited significantly less willingness to change their current behavior with 31% of these respondents selecting the Blue Water Bridge every time. Only 6% of Blue Water Bridge respondents always selected the new bridge, and the other 62% selected a combination of existing crossing and the new bridge.



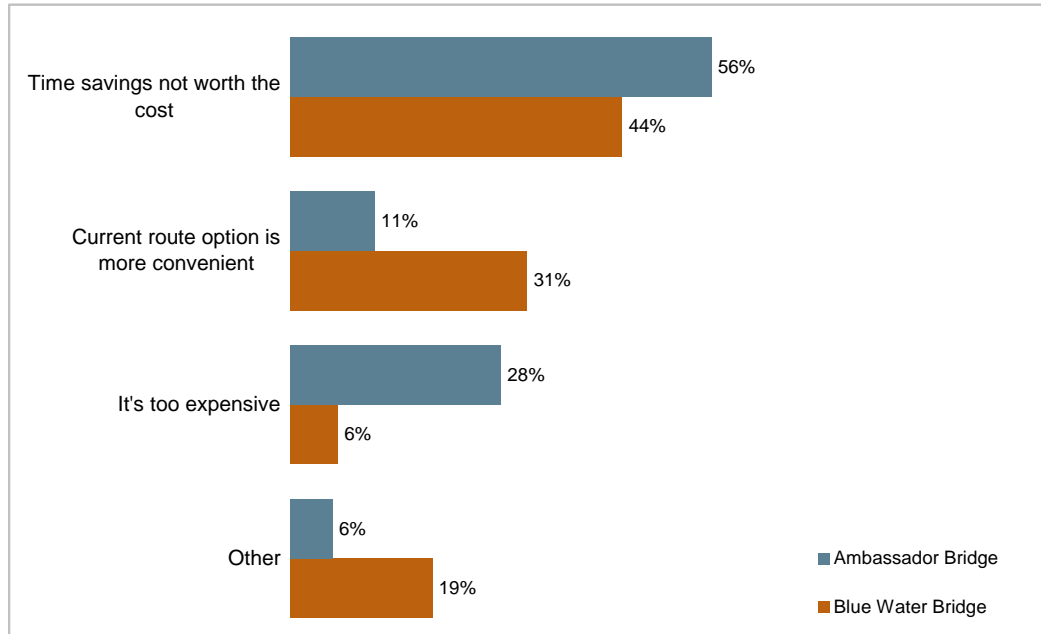
Figure 53: Commercial Vehicle Decision Maker Results – Stated Preference Behavior by Crossing



Thirty-four respondents, 18 Ambassador Bridge and 16 Blue Water Bridge, never selected the new bridge option in the stated preference exercise. When asked their primary reason for doing so, 56% of Ambassador Bridge respondents and 44% of Blue Water Bridge respondents said the time savings was not worth the cost, making this the most commonly reported reason for never selecting the new bridge option for both segments. Blue Water Bridge respondents were far more likely to cite the convenience of their current route and “other” reasons when explaining their aversion to the new bridge compared to Ambassador Bridge respondents. However, a greater proportion of Ambassador Bridge respondents (28%) selected “it’s too expensive” as the primary reason for not selecting the new bridge option at least once. Only 6% of Blue Water Bridge respondents reported the high cost of the new bridge as their primary reason for never selecting it (Figure 54).



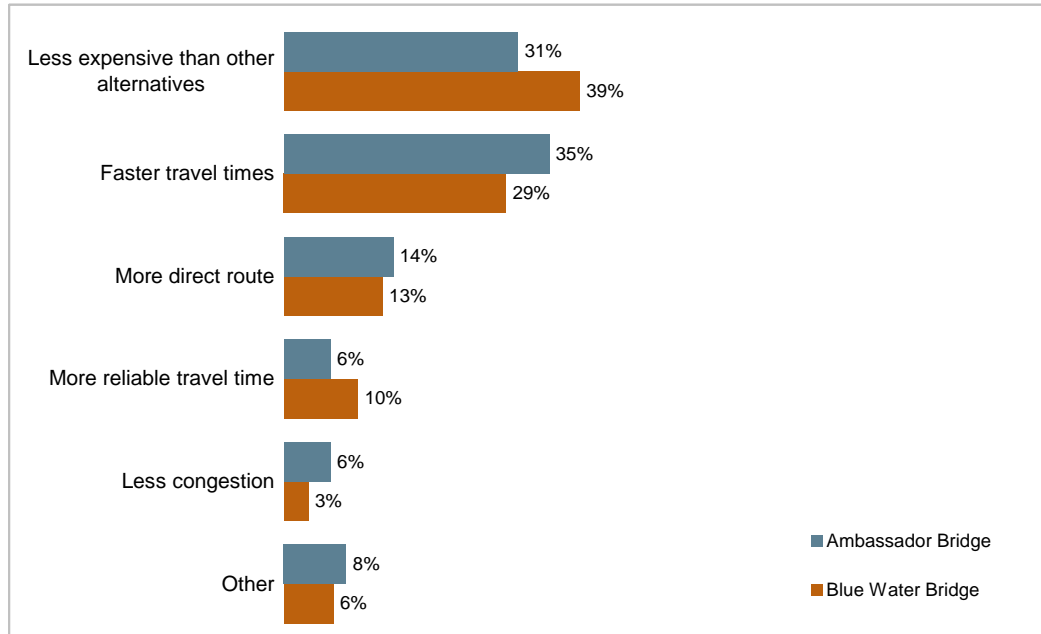
Figure 54: Commercial Vehicle Decision Maker Results – Primary Reason for Never Selecting New Bridge Option by Crossing



Eighty respondents, 49 Ambassador Bridge and 31 Blue Water Bridge, did select the new bridge option at least once in the stated preference exercise. When asked why they did select the new bridge option at least once, the most frequently cited reason was the less expensive cost of the new bridge relative to the other crossings. Thirty-one percent of Ambassador Bridge respondents and 39% of Blue Water Bridge respondents selected this as their primary reason. Faster travel times was another commonly cited explanation, accounting for 35% of Ambassador Bridge respondents' and 29% of Blue Water Bridge respondents' answers to this question (Figure 55).



Figure 55: Commercial Vehicle Decision Maker Results – Primary Reason for Selecting New Bridge Option by Crossing

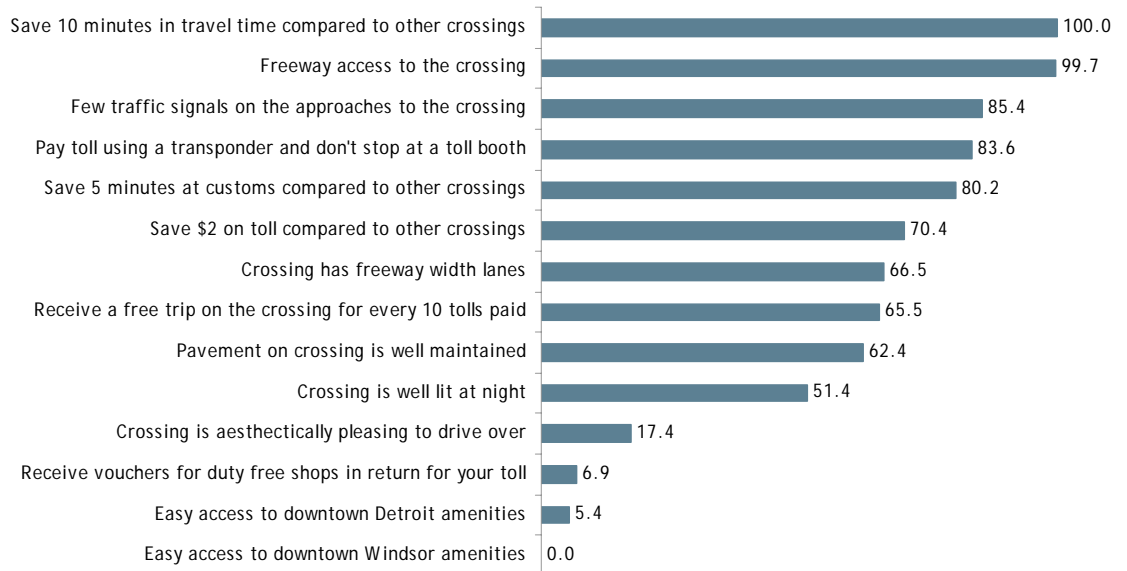


Commercial Vehicle Decision Makers MaxDiff

The answers to MaxDiff tradeoff scenarios were compiled into a data set with seven records per respondent. Each record consisted of the four attributes presented in the experiment, as well as the attribute that was selected as the most important and the attribute that was selected as the least important. A statistical analysis was conducted to estimate a set of utilities for each attribute. These utilities can be used to compare the relative importance of each attribute. Figure 56 presents the results for the MaxDiff. The utilities have been scaled such that the least important attribute has a value of zero and the most important attribute has a value of 100.



Figure 56: Commercial Vehicle Decision Maker Results – MaxDiff Scaled Utilities

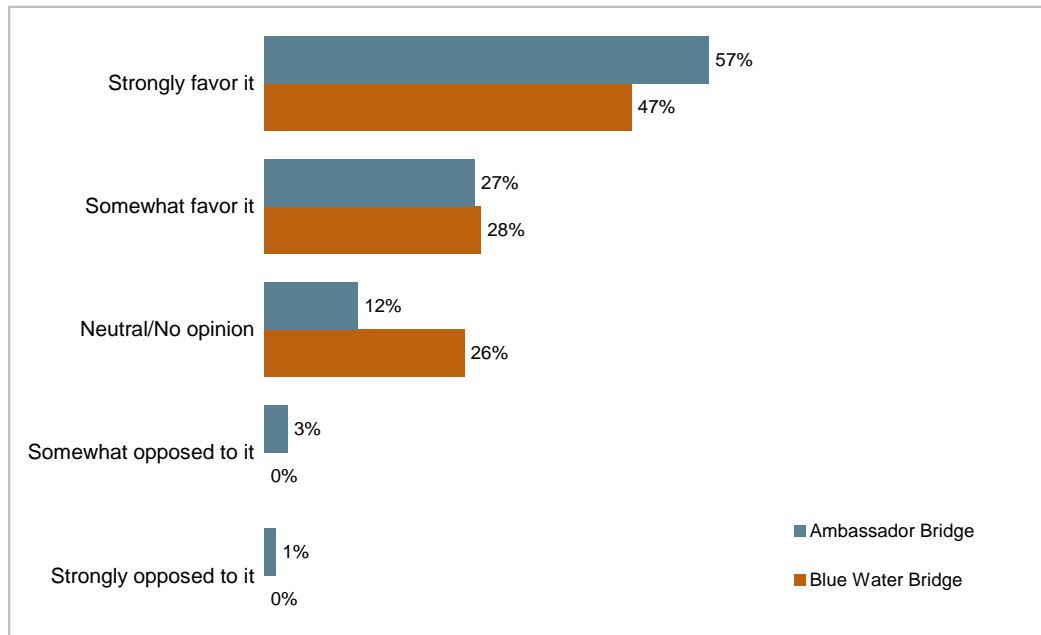


Commercial Vehicle Decision Makers Opinion

Respondents for the decision maker survey expressed a very favorable opinion of the proposed new bridge. Eighty-four percent of Ambassador Bridge respondents favor the proposed new bridge, and 57% strongly favor it. As for Blue Water Bridge respondents, 75% favor the new bridge, and 28% strongly favor it. The overwhelming majority of respondents in both segments who do not favor the new bridge expressed a neutral opinion of it (Figure 57).



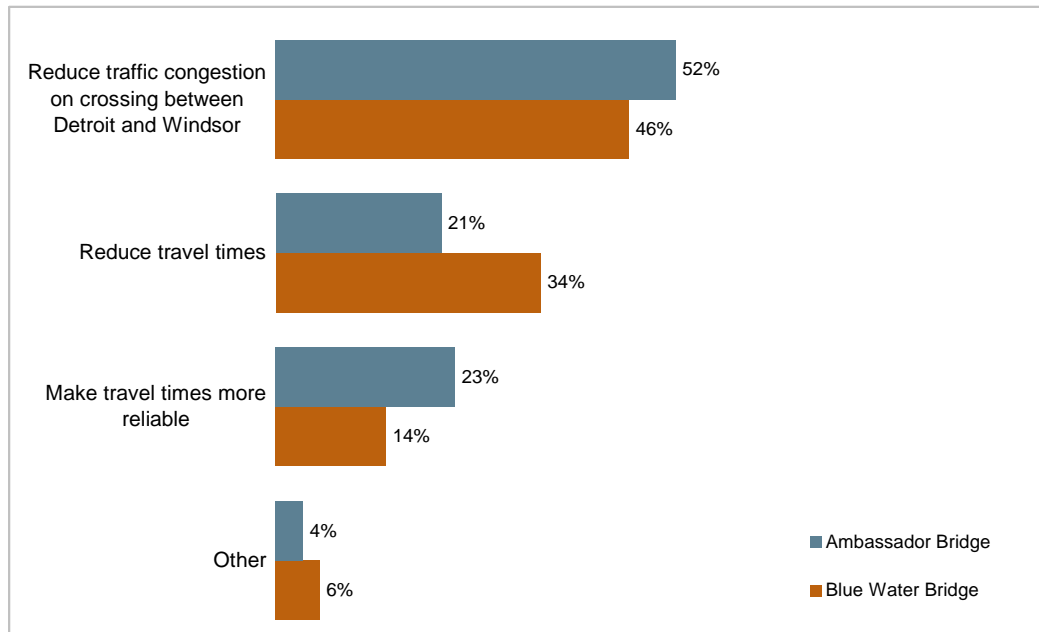
Figure 57: Commercial Vehicle Decision Maker Results – Opinion of New Bridge by Crossing



When asked why they favor the proposed new bridge, the most common response from both Ambassador Bridge and Blue Water Bridge respondents was a reduction in traffic congestion between Detroit and Windsor. Fifty-two percent of Ambassador Bridge respondents and 46% of Blue Water Bridge respondents reported this as the primary reason they favor the new bridge. Blue Water Bridge respondents (34%) were more likely to select a reduction in travel times to explain their favorable opinion of the new bridge compared to Ambassador Bridge respondents (21%). Conversely, Ambassador Bridge respondents selected more reliable travel times with greater frequency than their Blue Water Bridge counterparts (Figure 58).



Figure 58: Commercial Vehicle Decision Maker Results – Primary Reason New Bridge Favored by Crossing



Only three respondents, all Ambassador Bridge respondents, from the entire decision maker sample oppose the new bridge. Two of these respondents indicated there were “other” reasons for their opposition, while the other opposed respondent cited the adverse environmental impact of the new bridge.

Demographics

The decision maker survey concluded with a few more questions specific to respondents’ companies and trips their drivers make. When asked the average trip length of their drivers’ trips, the sample was split fairly evenly between medium and long hauls. Medium hauls, which are 301 to 800 kilometers or 187 to 497 miles in length, characterized 45% of respondents’ drivers’ average trip length. Forty-seven percent of respondents said their drivers’ average trip length was a long haul of more than 800 kilometers or 497 miles. The remaining respondents indicated average trip lengths that were local (less than 80 kilometers or 50 miles) or short hauls (81 to 300 kilometers or 50 to 186 miles).

Other manufactured products or equipment were the most commonly reported type of goods. Forty-eight percent of respondents said their drivers typically carry this type of goods. The second and third most common type of goods were miscellaneous goods and manufactured metal or mineral products. Respectively, 37% and 36% of respondents indicated these types of goods as typically carried by their drivers. Some other common types of goods were the following: food, alcohol, and tobacco products; forestry, wood, and paper products; and time-sensitive goods. Approximately 25% of respondents reported each of these types of goods.



When asked what type of shipments their companies handle, 84% of respondents said they handle a truckload, which are shipments that weigh at least 4,536 kilograms or 10,000 pounds and do not require a terminal or break-bulk operation. Shipments that are less than a truckload weigh less than 45 kilograms or 100 pounds and require terminal or break-bulk operation. Twelve percent of respondents indicated their companies handle shipments that are less than a truckload.

STATED PREFERENCE MODEL ESTIMATION

The objective of the stated preference surveys was to estimate reliable values of the toll sensitivity, or values of time (VOT), of automobile travelers, commercial vehicle drivers, and commercial vehicle fleet dispatchers and managers who might use the new bridge between Detroit and Windsor. Estimates of toll price sensitivity of travelers who might use the new route will support estimates of traffic and revenue on the proposed bridge.

Several methods of discrete choice model estimation were carried out using the stated preference survey data. The various statistical estimation and specification tests were completed using conventional maximum likelihood procedures that estimated both a set of aggregate coefficients for each market segment of interest as well as individual level coefficients for each respondent in the sample. The coefficients provide information about the relative importance of travel time and toll cost that can be used to infer travelers' VOT.

METHODOLOGY AND ALTERNATIVES

Automobile and commercial vehicle respondents were both presented with the same set of three or four alternatives depending on trip origin and destination:

1. New Bridge (Detroit-Windsor)
2. Ambassador Bridge (Detroit-Windsor)
3. Detroit-Windsor Tunnel (Detroit-Windsor)
4. Blue Water Bridge (Port Huron-Sarnia) (*if applicable*)

The Blue Water Bridge was only presented to respondents when it was determined to be a reasonable alternative to the Detroit-Windsor crossings. For the purposes of this survey, the Blue Water Bridge was considered a reasonable alternative when the travel time for the Blue Water Bridge was less than 45 minutes longer than their current crossing for automobile travelers and less than 90 minutes longer than their current crossing for commercial vehicle respondents.

Responses from the stated preference experiments were expanded into a dataset containing eight observations for each respondent. The data were used to estimate coefficients for three major classes of logit choice for both automobile and commercial vehicle respondents:

1. Multinomial Logit Model (MNL)
2. Nested Logit Model (NL)
3. Mixed Multinomial Logit Model (MMNL)



The individual methodology for each of the three types of logit models will be described in more detail below.

IDENTIFICATION OF OUTLIERS

Prior to estimation, the data were screened to ensure that all observations included in the model estimation represented realistic trips and reasonable consideration of the tradeoffs in the stated preference exercises. For both automobile and commercial vehicles, various variables were used for screening purposes. This included examining respondent source, travel time, origin and destination locations, route selection, and invariance (selection of only one alternative for all eight experiments in the stated preference section).

Statistical outlier analyses were carried out to identify respondents with extremely low choice probabilities in the models. This included a post-estimation examination of the probability of each respondent's choices.

Although most of the inconsistent responses were identified and removed through the use of error messages and confirmation screens as the survey was being administered, a few additional responses were screened out as a result of these tests. Table 15 shows the total number of respondents and observations for automobiles, commercial vehicle drivers, and commercial vehicle fleet dispatchers and managers after removing outliers.

Table 15: Stated Preference Observations

Respondent Classification	Respondents	Observations
Automobile	848	6,784
Commercial Vehicle Driver	293	2,344
Commercial Vehicle Fleet Dispatcher or Manager	122	976
Total	1,263	10,104

MULTINOMIAL LOGIT MODEL ESTIMATION

Initial model work involved the estimation of a multinomial logit (MNL) model¹. The MNL model estimation results in a single set of coefficients for all observations in the sample, or a subset of observations in the sample.

¹ The multinomial logit model has the general form $p(i) = \frac{e^{U_i}}{\sum_{AllModes} e^{U_j}}$ where $p(i)$ is the probability that mode i will be chosen

and U_i is the "utility" of mode i , a function of service and other variables. See, for example, M. E. Ben-Akiva and S. R. Lerman, *Discrete Choice Analysis*, MIT Press, 1985, for details on the model structure and statistical estimations procedures.



MNL Model Specification

Several utility equation structures were tested using the variables included in the stated preference experiments, as well as trip characteristic and demographic variables. Specification testing included evaluation of various alternative-specific constants, variables to account for possible strategic bias, and interactions between time and cost variables and household income, trip distance, trip frequency, and time of day.

The final specification for both automobiles and commercial vehicles included variables for travel time and toll cost, which applied to all four alternatives, as well as alternative specific constants for 3 of the 4 alternatives. Details of the specification are outlined below in Table 16.

Table 16: MNL Model specification for Automobile and Commercial Vehicle Data

Coefficient	Units	Alternatives			
		New Bridge	Ambassador Bridge	Detroit-Windsor Tunnel	Blue Water Bridge
Travel Time	minutes	X	X	X	X
Toll Cost	dollars	X	X	X	X
Ambassador Bridge Constant	(0,1)		X		
Detroit-Windsor Tunnel Constant	(0,1)			X	
Blue Water Bridge Constant	(0,1)				X

MNL Model Results

Table 17 through Table 19 present the MNL results for automobile travelers, commercial vehicle drivers, and commercial vehicle decision makers, respectively. Coefficient values, t-tests, and log-likelihood values are included for each model.

Table 17: Automobile MNL Coefficients

Coefficient	Units	Value	Std err	t-test
Travel time	minutes	-0.089	0.004	-20.8
Toll cost	dollars	-0.526	0.016	-33.5
Ambassador Bridge constant	(0,1)	-0.475	0.033	-14.5
Detroit-Windsor Tunnel constant	(0,1)	-0.395	0.032	-12.5
Blue Water Bridge constant	(0,1)	-0.271	0.065	-4.2
Number of observations	6784			
Initial log-likelihood	-7876.454			
Final log-likelihood	-7017.593			



Table 18: Commercial Vehicle Driver MNL Coefficients

Coefficient	Units	Value	Std err	t-test
Travel time	minutes	-0.068	0.007	-9.6
Toll cost	dollars	-0.057	0.009	-6.6
Ambassador Bridge constant	(0,1)	-0.684	0.053	-13.0
Detroit-Windsor Tunnel constant	(0,1)	-2.210	0.103	-21.4
Blue Water Bridge constant	(0,1)	-0.648	0.064	-10.1
Number of observations	2344			
Initial log-likelihood	-3058.45			
Final log-likelihood	-2489.73			

Table 19: Commercial Vehicle Decision Maker MNL Coefficients

Coefficient	Units	Value	Std err	t-test
Travel time	minutes	-0.087	0.012	-7.3
Toll cost	dollars	-0.152	0.014	-10.8
Ambassador Bridge constant	(0,1)	-0.615	0.085	-7.3
Detroit-Windsor Tunnel constant	(0,1)	-1.890	0.129	-14.6
Blue Water Bridge constant	(0,1)	-0.388	0.087	-4.5
Number of observations	976			
Initial log-likelihood	-1311.6			
Final log-likelihood	-1121.68			

MNL Model Trip Distance Segmentation

Several variables were used to segment the automobile and commercial vehicle model estimations, including trip purpose, trip distance, trip frequency, and time of day. Ultimately, segmentation by trip distance proved the most useful in the application of the models. This segmentation was achieved by estimating separate time and cost coefficients for short distance and long distance trips. For convenience, a short distance trip was defined as a trip where the Blue Water Bridge was not an available alternative in the stated preference experiments. Specifically, this included trips where the travel time across the Blue Water Bridge was less than 45 minutes longer than the travel time using the respondent's reported crossing for automobiles, and less than 90 minutes longer than the travel time using their reported crossing for commercial vehicles. In both cases, the travel times being compared came from the regional network model. Table 20 through Table 22 show the results of this segmentation for automobile, commercial vehicle driver, and commercial vehicle decision maker respondents.



Table 20: Automobile MNL Coefficients Segmented by Trip Distance

Coefficient	Units	Value	Std err	t-test
Travel time - long trips	minutes	-0.079	0.007	-11.7
Travel time - short trips	minutes	-0.091	0.006	-16.5
Toll cost - long trips	dollars	-0.365	0.027	-13.6
Toll cost - short trips	dollars	-0.584	0.020	-29.9
Ambassador Bridge constant	(0,1)	-0.467	0.033	-14.1
Detroit-Windsor Tunnel constant	(0,1)	-0.365	0.032	-11.3
Blue Water Bridge constant	(0,1)	-0.279	0.066	-4.3
Number of observations	6784			
Initial log-likelihood	-7876.45			
Final log-likelihood	-6978.34			

Table 21: Commercial Vehicle Driver MNL Coefficients Segmented by Trip Distance

Coefficient	Units	Value	Std err	t-test
Travel time - long trips	minutes	-0.059	0.008	-7.7
Travel time - short trips	minutes	-0.105	0.018	-5.7
Toll cost - long trips	dollars	-0.042	0.010	-4.3
Toll cost - short trips	dollars	-0.127	0.020	-6.3
Ambassador Bridge constant	(0,1)	-0.696	0.053	-13.1
Detroit-Windsor Tunnel constant	(0,1)	-2.250	0.105	-21.5
Blue Water Bridge constant	(0,1)	-0.625	0.064	-9.8
Number of observations	2344			
Initial log-likelihood	-3058.45			
Final log-likelihood	-2480.70			

Table 22: Commercial Vehicle Decision Maker MNL Coefficients Segmented by Trip Distance

Coefficient	Units	Value	Std err	t-test
Travel time - long trips	minutes	-0.086	0.012	-6.9
Travel time - short trips	minutes	-0.089	0.051	-1.8
Toll cost - long trips	dollars	-0.146	0.015	-10.0
Toll cost - short trips	dollars	-0.183	0.049	-3.8
Ambassador Bridge constant	(0,1)	-0.626	0.085	-7.3
Detroit-Windsor Tunnel constant	(0,1)	-1.920	0.132	-14.5
Blue Water Bridge constant	(0,1)	-0.393	0.087	-4.5
Number of observations	976			
Initial log-likelihood	-1311.60			
Final log-likelihood	-1120.53			

MNL Model Values of Time

The marginal rate of substitution of the travel time and toll cost coefficients provide the implied value that travelers place on their time (VOT) in terms of their willingness to pay a toll for travel time



savings. The values of time calculated from the time and cost coefficients of the MNL models are shown in Table 23.

Table 23: MNL Values of Time

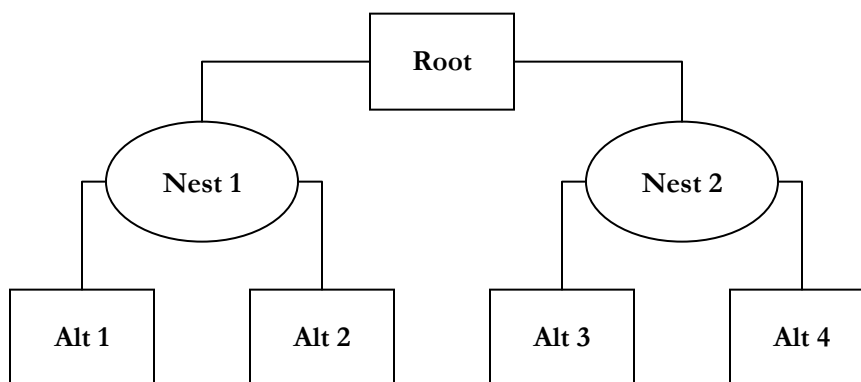
Respondent Group	VOT (\$/hr)		
	Long Dist	Short Dist	Combined
Automobile	\$12.99	\$9.34	\$10.13
Commercial Vehicle Driver	\$85.59	\$49.61	\$70.77
Commercial Vehicle Decision Maker	\$35.14	\$29.18	\$34.30

NESTED LOGIT MODEL ESTIMATION

After a suitable specification was identified in the multinomial logit model estimation, nested logit models were estimated using the final MNL specification. Nested logit models can offer advantages over MNL models in certain choice situations by relaxing the MNL assumption of independence of irrelevant alternatives (IIA). This assumption becomes restrictive when some alternatives in the model may be closer substitutes for each other than others. For example, because of their proximity to the proposed new bridge, the Ambassador Bridge and the Detroit-Windsor Tunnel might be closer substitutes for the new bridge than the Blue Water Bridge. Thus, if the utility for the new bridge alternative is increased, it would be expected that more share would be captured from the Ambassador Bridge and Detroit-Windsor Tunnel than from the Blue Water Bridge.

The nested logit model is most easily represented by a tree diagram with branches and nests. It is important to note that the tree diagram is an econometric tree, not a behavioral tree, and does not imply sequential choice behavior.

Figure 59: Sample Nested Logit Structure Represented by a Tree Diagram



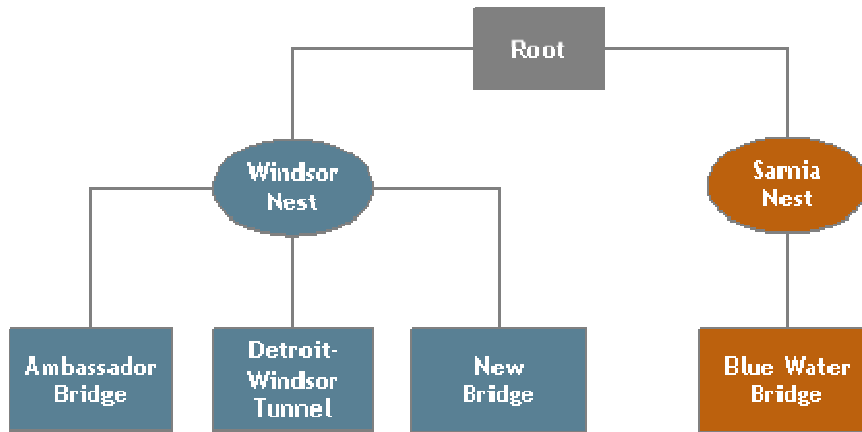
Alternatives nested together are better substitutes for each other, and the IIA assumption holds within nests, but not across nests. Proportional substitution will occur between alternatives 1 and 2, but not between alternatives 1 and 3 or 1 and 4.



Nesting Structure 1

Several different nesting structures were tested using the automobile and commercial vehicle data. Nests were generally grouped by location (Detroit-Windsor vs. Port Huron-Sarnia) and type of facility (Bridges vs. Tunnel). The two nesting structures outlined in this report grouped alternatives into nests by location. The first structure, shown in Figure 60, simply split the Detroit-Windsor alternatives into one nest and the Blue Water Bridge into a second nest.

Figure 60: Nesting Structure 1



The model coefficients and fit statistics for nesting structure 1 are shown below in Table 24 through Table 26.

Table 24: Automobile Nested Logit Model Coefficients for Nesting Structure 1

Coefficient	Units	Value	Std err	t-test
Travel time	minutes	-0.093	0.005	-19.7
Toll cost	dollars	-0.552	0.017	-32.4
Ambassador Bridge constant	(0,1)	-0.480	0.033	-14.5
Detroit-Windsor Tunnel constant	(0,1)	-0.405	0.032	-12.7
Blue Water Bridge constant	(0,1)	-0.904	0.239	-3.8
Nest Thetas				
Nest theta: Detroit-Windsor crossings		0.581	0.082	7.1
Nest theta: Blue Water Bridge		0.581	0.082	7.1
Number of observations	6784			
Initial log-likelihood	-1164.98			
Final log-likelihood	-7006.00			



Table 25: Commercial Vehicle Driver Nested Logit Model Coefficients for Nesting Structure 1

Coefficient	Units	Value	Std err	t- test
Travel time	minutes	-0.084	0.013	-6.7
Toll cost	dollars	-0.079	0.018	-4.5
Ambassador Bridge constant	(0,1)	-0.704	0.057	-12.3
Detroit-Windsor Tunnel constant	(0,1)	-2.270	0.120	-18.9
Blue Water Bridge constant	(0,1)	-1.180	0.473	-2.5
Nest Thetas				
Nest theta: Detroit-Windsor crossings		0.684	0.190	3.6
Nest theta: Blue Water Bridge		0.684	0.190	3.6

Number of observations	2344
Initial log-likelihood	-3737.37
Final log-likelihood	-2488.87

Table 26: Commercial Vehicle Decision Maker Nested Logit Model Coefficients for Nesting Structure 1

Coefficient	Units	Value	Std err	t- test
Travel time	minutes	-0.084	0.021	-4.1
Toll cost	dollars	-0.206	0.020	-10.4
Ambassador Bridge constant	(0,1)	-0.735	0.093	-7.9
Detroit-Windsor Tunnel constant	(0,1)	-2.370	0.174	-13.6
Blue Water Bridge constant	(0,1)	-2.673	1.094	-2.4
Nest Thetas				
Nest theta: Detroit-Windsor crossings		0.267	0.091	2.9
Nest theta: Blue Water Bridge		0.267	0.091	2.9

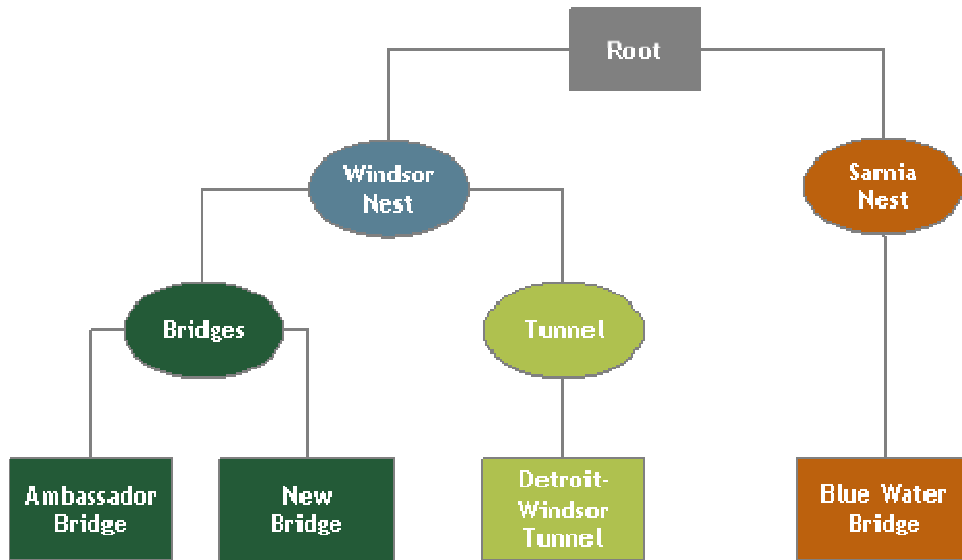
Number of observations	976
Initial log-likelihood	-1471.91
Final log-likelihood	-1106.35

Nesting Structure 2

The second nesting structure, shown in Figure 61, was similar to the first, but further segmented the Detroit-Windsor alternatives into two sub-nests for the bridge alternatives and the tunnel alternative.



Figure 61: Nesting Structure 2



The model coefficients and fit statistics for nesting structure 2 are shown below in Table 27 through Table 29.

Table 27: Automobile Nested Logit Model Coefficients for Nesting Structure 2

Coefficient	Units	Value	Std err	t- test
Travel time	minutes	-0.113	0.006	-18.3
Toll cost	dollars	-0.718	0.023	-30.8
Ambassador Bridge constant	(0,1)	-0.513	0.035	-14.5
Detroit-Windsor Tunnel constant	(0,1)	-0.964	0.088	-10.9
Blue Water Bridge constant	(0,1)	-1.201	0.437	-2.7
Nest Thetas				
Nest theta: Bridges		0.578	0.037	15.5
Nest theta: Tunnel		0.578	0.037	15.5
Nest theta: Blue Water Bridge Dummy		0.578	0.037	15.5
Nest theta: Detroit-Windsor crossings		0.743	0.160	4.6
Nest theta: Blue Water Bridge		0.743	0.160	4.6
Number of observations	6784			
Initial log-likelihood	-12143.25			
Final log-likelihood	-6964.94			



Table 28: Commercial Vehicle Driver Nested Logit Model Coefficients for Nesting Structure 2

Coefficient	Units	Value	Std err	t- test
Travel time	minutes	-0.089	0.013	-6.8
Toll cost	dollars	-0.087	0.013	-6.4
Ambassador Bridge constant	(0,1)	-0.714	0.056	-12.7
Detroit-Windsor Tunnel constant	(0,1)	-2.689	1.051	-2.6
Blue Water Bridge constant	(0,1)	-1.347	0.403	-3.3
Nest Thetas				
Nest theta: Bridges		0.868	0.298	2.9
Nest theta: Tunnel		0.868	0.298	2.9
Nest theta: Blue Water Bridge Dummy		0.868	0.298	2.9
Nest theta: Detroit-Windsor crossings		0.716	0.261	2.7
Nest theta: Blue Water Bridge		0.716	0.261	2.7
Number of observations	2344			
Initial log-likelihood	-4206.71			
Final log-likelihood	-2488.77			

Table 29: Commercial Vehicle Decision Maker Nested Logit Model Coefficients for Nesting Structure 2

Coefficient	Units	Value	Std err	t- test
Travel time	minutes	-0.099	0.021	-4.6
Toll cost	dollars	-0.233	0.024	-9.7
Ambassador Bridge constant	(0,1)	-0.779	0.097	-8.1
Detroit-Windsor Tunnel constant	(0,1)	-3.253	0.720	-4.5
Blue Water Bridge constant	(0,1)	-2.856	1.099	-2.6
Nest Thetas				
Nest theta: Bridges		0.696	0.181	3.9
Nest theta: Tunnel		0.696	0.181	3.9
Nest theta: Blue Water Bridge Dummy		0.696	0.181	3.9
Nest theta: Detroit-Windsor crossings		0.359	0.146	2.4
Nest theta: Blue Water Bridge		0.359	0.146	2.4
Number of observations	976			
Initial log-likelihood	-1620.58			
Final log-likelihood	-1104.70			

Nested Logit Values of Time

As with the MNL models, the marginal rate of substitution of the travel time and toll cost coefficients in the NL models provide the implied value that travelers place on their time (VOT) in terms of their willingness to pay a toll for travel time savings. The values of time calculated from the time and cost coefficients of the NL models are shown in Table 30.



Table 30: NL Values of Time

Segment	Structure 1 VOT (\$/hr)	Structure 2 VOT (\$/hr)
Automobile	\$10.16	\$9.47
Commercial Vehicle Driver	\$63.35	\$61.49
Commercial Vehicle Decision Maker	\$24.47	\$25.49

MIXED LOGIT MODEL ESTIMATION

In general, there are two main ways of dealing with taste heterogeneity in logit models. The first involves the deterministic or systematic representation of taste heterogeneity. This type of taste heterogeneity can be captured in the model specification and segmentation of MNL and NL models. However, some taste heterogeneity cannot be explained deterministically; there are actual random variations of taste among individuals. This random representation of taste heterogeneity can be captured using mixed multinomial logit (MMNL) models.

Following specification tests using MNL and NL model forms, MMNL models were estimated for automobiles and commercial vehicles. The MMNL models capture individual preference heterogeneity not accounted for in MNL or NL models by segmentation or model specification and allow VOT distributions to be estimated for each segment.

MMNL models were estimated for the automobile and commercial vehicle driver samples using the same specification identified in the preliminary MNL models. The coefficients for time, cost, and all three alternative specific constants were estimated as random variables with normal distributions. The toll cost standard deviation estimate was found to be statistically insignificant for the commercial vehicle driver group; therefore this coefficient was estimated as non-random. The comparatively small sample size for the commercial vehicle decision makers segment prevented the estimation of statistically significant MMNL coefficients for this group. As a result, no MMNL model results are presented for commercial vehicle decision makers.

The MMNL estimation results for automobiles and commercial vehicle drivers are found in Table 31 and Table 32. The tables include model coefficient values, t-statistics, and the final log-likelihood for each model. The t-statistics show that the standard deviations for each coefficient are significantly different from zero in both models, indicating that the models are identifying heterogeneity among the respondents with respect to those coefficients.



Table 31: Automobile Mixed Logit Coefficients

Coefficient	Units	Value	Std err	t-test
Travel time mean	minutes	-0.172	0.012	-14.9
Travel time standard deviation	minutes	0.120	0.014	8.7
Toll cost mean	dollars	-1.449	0.059	-24.7
Toll cost standard deviation	dollars	0.893	0.051	17.5
AMB constant mean	(0,1)	-1.290	0.136	-9.5
AMB constant standard deviation	(0,1)	2.736	0.142	19.3
DWT constant mean	(0,1)	-1.450	0.170	-8.5
DWT constant standard deviation	(0,1)	4.101	0.212	19.3
BWB constant mean	(0,1)	-4.599	0.779	-5.9
BWB constant standard deviation	(0,1)	7.422	0.777	9.6

Number of observations 6784

Final log-likelihood -4464.319

Table 32: Commercial Vehicle Driver Mixed Logit Coefficients

Coefficient	Units	Value	Std err	t-test
Travel time mean	minutes	-0.174	0.022	-8.0
Travel time standard deviation	minutes	0.160	0.017	9.5
Toll cost	dollars	-0.248	0.025	-10.0
AMB constant mean	(0,1)	-2.286	0.265	-8.6
AMB constant standard deviation	(0,1)	3.580	0.305	11.7
DWT constant mean	(0,1)	-9.264	0.982	-9.4
DWT constant standard deviation	(0,1)	6.887	0.733	9.4
BWB constant mean	(0,1)	-5.097	0.591	-8.6
BWB constant standard deviation	(0,1)	7.146	0.876	8.2

Number of observations 2344

Final log-likelihood -1404.783

Value of Time Distributions

A benefit of MMNL model estimation is that it allows for the estimation of individual specific coefficients for each respondent in the sample. These individual specific coefficients can be used to calculate a VOT for each respondent, which allows for the development of a VOT distribution. Histograms of the VOT distributions for automobiles and commercial vehicle drivers are shown in Figure 62 and Figure 63, respectively.



Figure 62: Automobile Value of Time Distribution

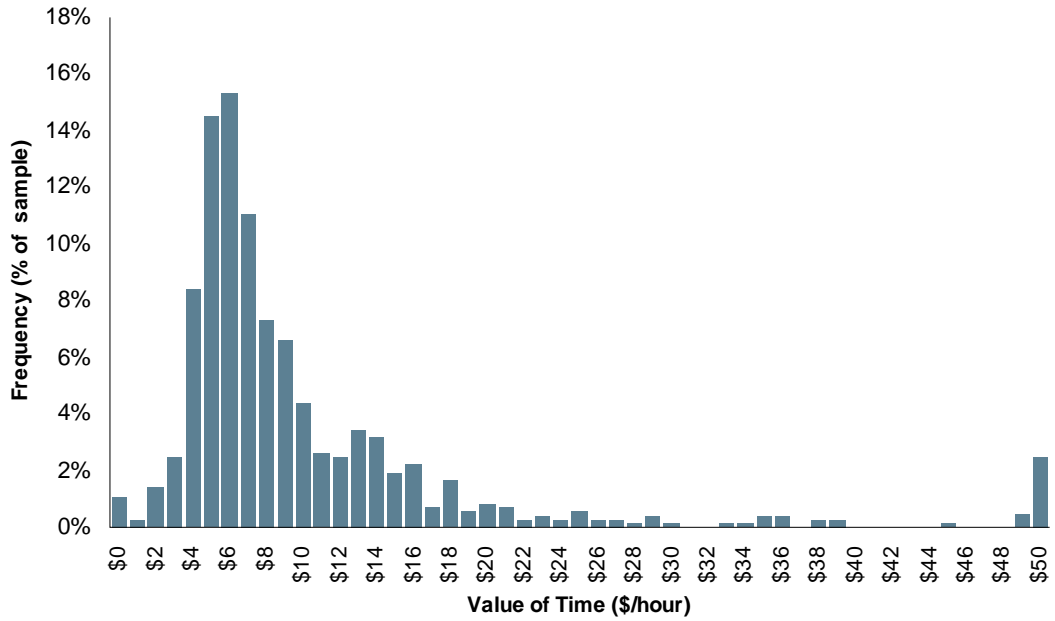
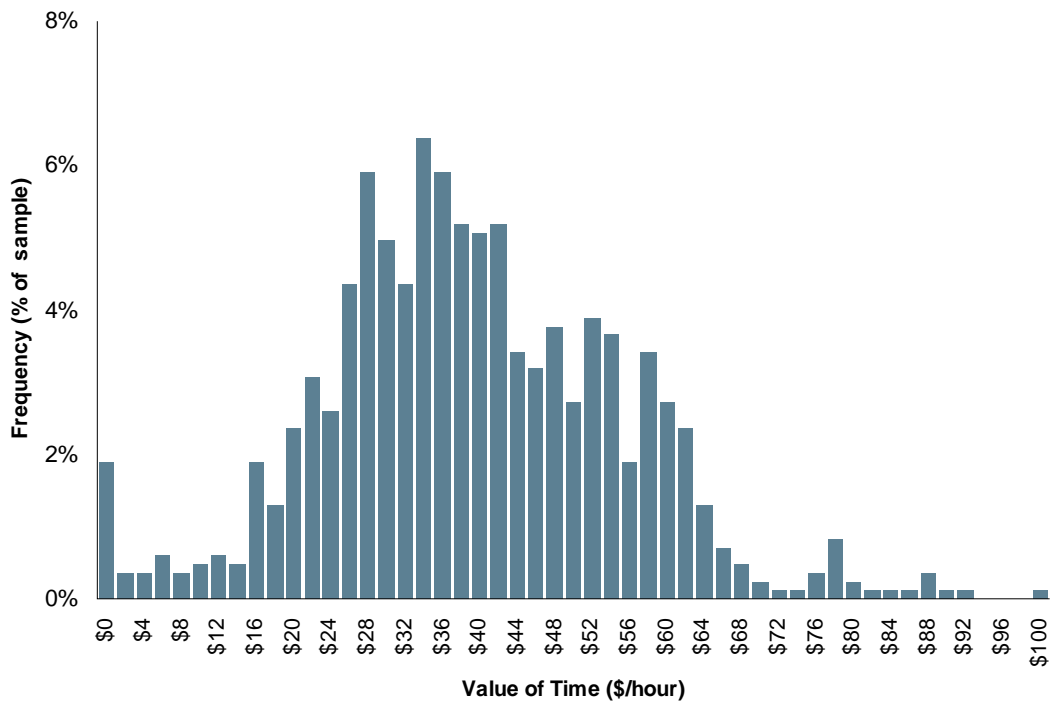


Figure 63: Commercial Vehicle Driver Value of Time Distribution



REVEALED PREFERENCE MODEL ESTIMATION

Revealed preference (RP) model estimation was carried out for automobiles and commercial vehicles concurrent with the SP model estimation. The RP datasets consisted of a set of origin-destination TAZ pairs with zone-to-zone travel time and toll cost information for each of the three existing crossings – the Ambassador Bridge, the Detroit-Windsor Tunnel¹, and the Blue Water Bridge.

AUTOMOBILE REVEALED PREFERENCE MODEL ESTIMATION

The automobile RP dataset consisted of origin-destination TAZ pairs from IBI Group's origin-destination survey and the revealed preference (trip description) portion of the SP survey. Zone-to-zone travel time and toll cost information for each of the three existing crossings was appended to each origin-destination record. Travel times were provided by IBI Group by skimming from the regional network model. Toll costs were calculated using the publicly available toll rate structures for each of the three crossings. At the time of the survey administration, toll rates for automobiles were \$2.75 for the Blue Water Bridge, \$3.75 for the Detroit-Windsor Tunnel, and \$4.00 for the Ambassador Bridge. As the exchange rate at the time of this study was nearly at-par, these costs were the same in U.S. and Canadian funds.

A revealed preference model was estimated using the data described above. The fact that the toll cost did not vary within a given alternative led to confounding issues between the toll cost coefficient and the alternative specific constants. For this reason, the toll cost coefficient and alternative specific constants could not be estimated simultaneously. Table 33 presents the automobile revealed preference coefficients and value of time.

Table 33: Automobile Revealed Preference Coefficients

Coefficient	Units	Value	Std err	t-test	VOT (\$/hr)
Travel Time	minutes	-0.126	0.002	-51.1	\$ 11.10
Toll Cost	dollars	-0.684	0.024	-28.5	

This RP model provides good validation for the values of time that were obtained from the SP models, and the time and cost coefficients could be used to scale the SP coefficients. However, these results should not be used for SP calibration due to the absence of alternative specific constants in the estimation.

COMMERCIAL VEHICLE REVEALED PREFERENCE MODEL ESTIMATION

Origin-destination TAZ pairs for the commercial RP dataset were obtained from the 2006 National Roadside Survey of Canada. This survey did not collect data on the Detroit-Windsor Tunnel; therefore, the RP dataset only included zone-to-zone travel time and toll cost information for two alternatives, the Ambassador Bridge and the Blue Water Bridge. As with the automobile dataset,

¹ Because the Detroit-Windsor Tunnel represents such a small portion of current cross-border commercial vehicle traffic, this alternative was omitted from the commercial vehicle RP estimation.



travel times were provided by IBI Group from the regional network model and toll costs were calculated using the publicly available toll rate structures for each of the three crossings. The toll rate calculations are described below in Table 34. Blue Water Bridge toll rates were dependent on both the direction of travel and the currency used for payment. As the payment currency was not available from the data, a single per-axle rate was applied for all vehicles.

Table 34: Facility Toll Rates for Commercial Vehicles

Facility	Gross Vehicle Weight	Toll Rate
Ambassador Bridge	0 - 38,000 lbs.	\$ 2.75 per axle
	38,001 lbs. - 56,000 lbs.	\$ 3.25 per axle
	56,001 lbs. - 145,000 lbs.	\$ 4.50 per axle
Blue Water Bridge	All weights	\$ 3.00 per axle

A revealed preference model was estimated using the data described above. In contrast to the automobile revealed preference model, toll costs did vary within each alternative as they were based on vehicle axles. Because of this, it was possible to estimate both a toll cost coefficient and an alternative specific constant without the confounding issues that arose in the automobile estimation. Table 35 presents the commercial vehicle RP coefficients and value of time.

Table 35: Commercial Vehicle Revealed Preference Coefficients

Coefficient	Units	Value	Std err	t-test	VOT (\$/hr)
Travel Time	minutes	-0.060	0.001	-44.7	\$ 85.08
Toll Cost	dollars	-0.043	0.005	-8.3	
Blue Water Bridge Constant	(0,1)	-1.161	0.029	-39.5	

As with the auto RP model, this RP model provides good validation for the values of time that were obtained from the SP models, and the time and cost coefficients could be used to scale the SP coefficients. However, these results should not be used for calibration of the SP models due to the absence of the Detroit-Windsor Tunnel from the estimation.



APPENDIX **C**

CORRIDOR GROWTH ASSESSMENT

This appendix contains the documentation of the corridor growth analysis as conducted by Centre for Spatial Economics and Wilbur Smith Associates.

THIS PAGE INTENTIONALLY LEFT BLANK

1. Introduction

The border between the United States and Canada has 3,145 miles of land and 2,380 miles of water¹, making it the longest shared border in the world. Bilateral merchandise trade traversing the border between the United States and Canada was estimated at \$596.9 billion² in 2008, not including the additional monetary value of international trade in services (non-merchandise trade) and cross-border investments. This volume of trade is the largest of any other bilateral trade between two individual countries.

International merchandise trade of this enormity across a shared border requires adequate transportation infrastructure, such as border crossings, to sustain and facilitate efficient trade movements. The operational efficiency of the infrastructure is a key factor in ensuring unhindered international trade, especially if the majority of that international commerce funnels through a limited number of crossings and is concentrated within a narrow geographic tract of the entire shared border.

The Southeast Michigan Council of Governments region in Michigan and the Windsor-Sarnia economic region in Ontario have three major border crossings – the Ambassador Bridge, the Detroit-Windsor Tunnel, and the Blue Water Bridge (hereafter referred to, collectively, as “the frontier”). Trade at these international border crossings is estimated to range between one-fifth and one-third³ of the total value in bilateral trade between the United States and Canada (depending on the definition and source). Significant levels of traffic are channeled through the frontier border crossings, all of which traverse geographically and politically dividing rivers (i.e., the Detroit and St. Clair Rivers). As the volume of bilateral trade increases, additional pressure will be placed on these existing facilities to handle the overall national and local passenger and commercial vehicle demand for the international crossings.

The growth in future traffic demand along the frontier corridors is requisite for determining potential infrastructure capacity shortages and the degree to which additional capacity may become necessary to accommodate the growth. The following analysis estimates the future corridor traffic growth for various traffic volume types across the entire frontier, and serves as a key variable input into travel demand models to determine the potential future infrastructure capacity shortages. The growth rates were derived for the entire frontier corridor to determine the unconstrained trend in passenger and commercial vehicle crossing demand, irrespective of the individual crossing points along the frontier. The methodology applied in the forecasting process as part of this refresh largely adopts the methodology applied in the previous (2008-09) study of the corridor. This methodology, as well as the ensuing corridor growth forecasts, are presented below, along with the rationale for the key assumptions embedded in the analysis.

¹ International Boundary Commission

² U.S. Bureau of Transportation Statistics

³ Transport Canada; Canadian Chamber of Commerce

2. Methodology

Forecasting efforts are conducted primarily with the objective of ascertaining the anticipated magnitude and direction of change in a variable, or variables, over time. The oftentimes irregular and unpredictable fluctuations in economic factors make econometric forecasting with absolute certainty difficult. Unprecedented and unpredictable factors, combined with annual historical vacillations in economic activity, further complicate forecasting decades into the future. Projected corridor growth rates are difficult to estimate mathematically because of the relative complexity of the factors affecting the growth patterns. The number of both quantifiable and unquantifiable factors, and the interaction among those factors, is important for determining growth trends and future potential. Despite the relative complexity, a reasonably acceptable trend can be established that characterizes long-term growth potential, while simultaneously dismissing short-term fluctuations in growth. Complex econometric modeling, though imperfect, serves as the most viable approach for estimating future corridor growth. In this analysis, an econometric technique known as a multivariate regression is applied. Multivariate regression analysis determines the mathematically correlative relationships between identified independent, or explanatory, socioeconomic variables and the dependent border crossing traffic. A time series analysis technique was conducted in the previous study and was considered as part of this study, however, the study team found the multivariate regression techniques to be a more effective descriptor of the data and trends.

Corridor growth rates are estimated for three separate types of traffic volumes: passenger vehicle crossings occurring within the same-day, passenger vehicle crossings occurring with a trip duration exceeding same-day (overnight), and commercial truck crossings. Growth rates for each of these three identified types of border crossing volumes are separately analyzed and presented.

In assessing the future potential growth in traffic at the international border crossings between the United States and Canada, located within the Detroit-Windsor-Sarnia corridors, a number of underlying fundamental assumptions were made in applying the econometric techniques utilized, as detailed within the following subsections.

2.1. Assumptions/Caveats

Analytical results of the potential traffic demand growth for the frontier corridors serve as the basis for the further derivations, or modeling, of the forecast vehicle crossing traffic levels. The growth forecasts are aggregate in nature and do not consider additional route choice assumptions and traffic volume, the existing roadway network and planned improvements, existing and anticipated roadway capacities, origin-destination trip pairing, peak and directional factors, traffic diversions, toll pricing schemes, etc. The vehicle crossing traffic volumes will be calculated through the application of the traffic demand model as a further model refinement task.

Corridor growth rate forecasts are limited by the availability and completeness of both historical and projected input data. Data unavailability at the disaggregate levels or within necessary market segments, along with discrepancies, and inaccuracies

encountered during this analysis, placed restrictions on the econometric forecasting ability and a series of assumptions had to be made to overcome these hindrances.

In this analysis, the emphasis is placed on the long-term forecast of the corridor demand growth; albeit realistically, fluctuations in growth may occur as a result of factors unexplainable within the econometric modeling process. Short-term fluctuations in explanatory economic variables, as well as the influence on economic variables by unprecedented and unforeseen factors, are subject to econometric forecasting error, and only as sound as the accuracy of the input data. A long-term focus of econometric forecasting is conducted with the intentions of minimizing the consequential error of short-term aberrations in the economic variables.

Multivariate Regression Techniques:

A multivariate regression equation only identifies the correlation of an independent variable, or variables, to one dependent variable and does not, without additional testing, identify the directional causality of the correlation. In other words, if independent variables are regressed against a dependent variable, and there is a significant statistical correlation between the independent and dependent variables, then the independent variables serve as a reasonable proxy for quantifying the dependent variable. However, the directional causality of the variables (which variable change directly triggers a change in the other variable(s)) cannot be determined without causal testing. As such, the independent socioeconomic variables applied in the econometric forecasting methods utilizing multivariate regression equations are proxy determinates for the dependent border crossings because of the calculated correlative coefficients; the independent socioeconomic variables, without causal testing, cannot be concluded to be the ultimate determinates, or direct cause, of border crossings, or vice versa.

Because the independent socioeconomic variables in the multivariate regression equations serve as proxy determinates for quantifying the forecast corridor growth, the corridor growth projections are only as realistic as the projections of the independent socioeconomic variables, provided for this analysis by various governmental and private sector agencies, which are comprehensively listed within the appropriately titled section.

Additionally, only select independent socioeconomic variables, such as those with sufficiently high statistically correlative properties, are applied to the final multivariate regression equation to determine corridor growth. Because only a select number of independent variables are included within the regression equations, the regressions, as a result, are unable to account for all the potentially influencing factors on the dependent border crossings. As is typical of regression-based models, the equations are reflective of the current explanatory patterns, which may not be constant throughout the forecast time horizon, therefore, the results of such regressions are subject to model risk.

In identifying the appropriate independent socioeconomic variables applied to the multivariate regression equations to determine corridor growth for the various traffic types, the geographic level of focus differs. A distinction in the geographic focus of the socioeconomic variables for each traffic type is made because it is assumed that the

traffic types are generally a function of the geographic distance from the international crossings.

In the multivariate regression modeling for same-day passenger vehicles, the same-day crossings are assumed to occur only within a half-day driving distance of the border, such as only to originate or terminate entirely within the state of Michigan or the province of Ontario (or, with various regression equation alternatives, a narrower geographic focus of only the SEMCOG region and/or the Windsor-Sarnia economic region). Consequently, the socioeconomic variables for the multivariate regression modeling of same-day passenger vehicles are variables pertaining only to the abovementioned geographic level. Commercial vehicle crossings and passenger vehicle crossings exceeding the same-day duration are assumed to be determined by socioeconomic variables for a geographic level of focus including and extending beyond Michigan and Ontario, to include national and bi-national socioeconomic variables.

In addition to the previously mentioned assumptions, it should be noted that a multivariate regression analysis is incapable of modeling unpredictable factors, which have either positive or negative influence on international border crossings, such as catastrophic climate change, international plagues or health epidemics, acts of international terrorism, drastic political change, immigration reforms, famine, extreme energy shocks, natural disasters, or any other significantly destabilizing factors.

2.2. Multivariate Regression Analysis

Cross-border traffic occurs for a number of reasons, including, but not limited to, recreation, commuting, and trade. Traffic border crossings are, to an extent, a function of the interactive nature of the two sides as they pertain to various socioeconomic variables, such as population, employment, gross domestic product, and exchange rates, among others. Socioeconomic variables, if numerically quantifiable, can be analyzed through multivariate regression analyses with respect to the magnitudes that those variables determine, or influence, the volumes of international border crossings.

A multivariate regression analysis is a mathematical application that quantifiably determines the correlative relationship between one dependent variable (border crossings) as a function of one or more independent variables (socioeconomic data). In a multivariate regression equation, predictions of the dependent variable can be determined by identifying appropriate correlative variables and their respective relationships.

Independent socioeconomic variables that have historically contributed significantly to border crossing volumes can be applied to the multivariate regression equations, to estimate the future values of the dependent variable (border crossing volumes). In this analysis, linear, least-square multivariate regressions are applied to the available data for analysis.

The initial identification of all possible quantifiable independent variables that may factor in the determination of border crossings was performed along with the data acquisition of the historical and projected values for those identified possible variables, and the multiple

multivariate regression runs. The multiple multivariate regression equations were run with the obtained data (where available) and indexed to a benchmark year (indexing does not misconstrue the actual data nor the results of the multivariate regression equations, but only simplifies the regression equations by removing the terms of the variables). Once all the reasonably postulated regressions were calculated, only one of the multivariate regressions was identified for each traffic volume type for the frontier. The chosen multivariate regression equation was the one that exhibited an acceptable level of quantitative and qualitative explanatory power for the border crossing volumes. Previously identified explanatory variables and the regression results were applied to the current refresh.

2.3. Data Collection

In order to reasonably conduct a multivariate regression for the purposes of estimating future patterns of growth, comprehensive historical and forecast data is requisite. Data are required for both the historical border crossing traffic volumes, by traffic type, as well as the key socioeconomic variables that purportedly correlate with the historical traffic volumes and serving as possible determinates for those traffic volumes. Data are essential to identifying whether the socioeconomic variables are highly correlative with the border crossing traffic volume and, thus, provide an explanatory basis for the traffic volumes. The forecasts of those variables are then applied to the calculated multivariate regression coefficients to estimate the level of future border crossing corridor growth.

Various private and governmental sector agencies were contacted directly for the purposes of obtaining data for the independent socioeconomic variables and the historical traffic volumes; however, only a portion of those contacted agencies were responsive with both available and applicable data. Where applicable, some of the sought after variables were openly available to the public and were directly acquired from the publicly available Internet sources or print publications. A detailed identification of the various sources for the data ultimately utilized is provided within **Exhibit 27**.

The various governmental agencies and private sector forecasting companies, from which data was obtained, include: the Michigan Department of Transportation, Transport Canada, Statistics Canada, Southeast Michigan Council of Governments (SEMCOG), Bank of Canada, the United States Census Bureau, and the United States Department of Commerce.

3. Historical Trends in Traffic Volumes and Explanatory Socioeconomic Variables

3.1. Historical Border Crossing Volumes

The historical patterns of growth were first identified for establishing the context prior to determining the projections of corridor traffic demand growth for the international frontier between Michigan and Ontario.

Annual historical time-series crossing traffic data for the frontier are generally available by vehicle type only (automobiles, trucks, and buses). It is important, however, to also

consider various market segments within the vehicle types when determining the potential future growth trends. Segmentation of the annual estimates of historical (1972 to 2008) vehicle data into key market segments were developed for commute/work, other same-day, and overnight trip purposes, using a variety of information sources. The disaggregation of the automobile crossings was performed to enable the modeling of regression equations for each crossing type, and identify the different independent socioeconomic variables influencing each market segment.

While total annual automobile traffic volumes were available from the Public Border Operator's Association (PBOA), the following outlines the additional sources of information used to determine the various market segments:

Transport Canada International Travel Survey

- An annual survey pertaining to the travel characteristics of U.S. residents entering Canada and Canadian residents returning from the U.S. Information in the survey includes annual trips made with a same-day duration (returning to the country of origin on the same-day) and overnight trips (beyond same-day) by port (Windsor and Sarnia) and by travel mode (automobile, airplane, and train). While shown separately, until 1997, information for the two Windsor crossings (Ambassador Bridge and the Detroit-Windsor Tunnel) was combined in, and following, 1997.
- The combined proportion of same-day and overnight trips was applied to the total trips. Pertaining to the two Windsor crossings, the relative relationship in 1997 was maintained for subsequent years.
- Inherent additional assumptions included:
 - Relative relationship of same-day to overnight passenger travel at the two Windsor crossings in 1997 was maintained through 2007.
 - Same-day and overnight passenger travel characteristics for travellers into the U.S. are the same as for travellers into Canada.
 - Automobile vehicle occupancy rates for both U.S. and Canadian travellers are identical.
 - Non-Canadian/U.S. residents travelling into Canada have the same travel characteristics as those surveyed.

2000 Michigan-Ontario Border Crossing Traffic Study

- It is a detailed survey of passenger automobile travel characteristics at the study crossings, conducted in August of 2000, representing a typical weekday; information includes trip purpose.
- For the year 2000 only, the proportion of commute/work trips of total travel observed in the survey, and adjusted to account for weekends, was applied to the total annual vehicles at each crossing.

- Inherent assumptions were that the proportion of commute/work trips in the survey is representative of that proportion for the entire year.

2008 Origin-Destination Survey at Detroit-Windsor and Port Huron-Sarnia Crossings

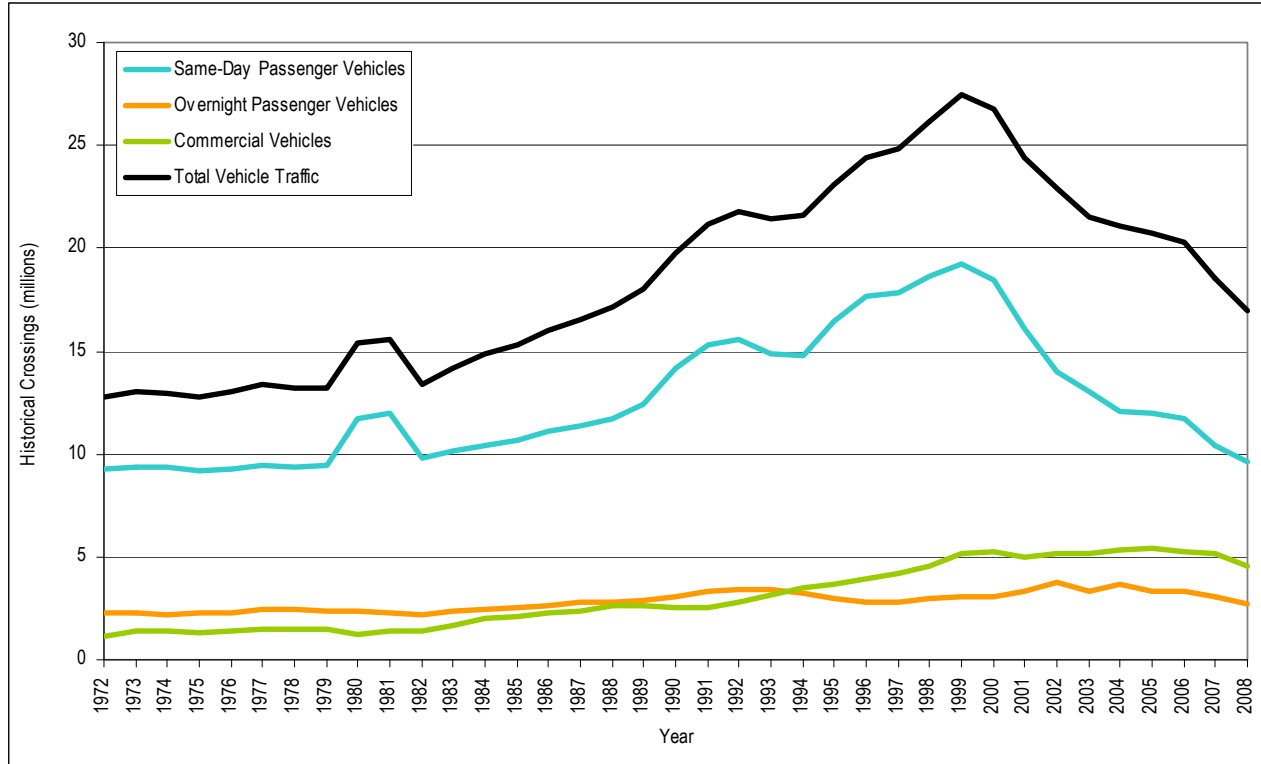
- The OD survey was performed during two weekdays in April 2008 at the three crossings of Ambassador Bridge, Detroit-Windsor Tunnel and Blue Water Bridge.
- The trip purpose information collected during the survey was used to split the passenger car traffic for 2008 with the adjustment to account for weekends.
- The interim years between 2000 and 2008 are interpolated based on the 2000 and 2008 statistics.
- Inherent assumptions were that the proportion of commute/work trips in the survey is representative of that proportion for the entire year.

Statistics Canada Place of Residence/Place of Work Data

- Includes estimates of the number of Canadian residents in the Windsor Census Metropolitan Area (CMA), employed outside Canada; data were available for the 1981, 1991, 1996, 2001 and 2006 census years.
- Using 2001 as the base year for the census data and the 2000 estimate of commute/work trips, the ratio of each census year to the 2001 base year was applied to the 2000 estimate to obtain estimates for each of the other years for the two Windsor crossings. Commute/work trips were not estimated for the Sarnia crossing. Data was then interpolated for the remaining years following the same day trips trend.
- Inherent additional assumptions included:
 - Number of residents in the Windsor CMA and employed outside Canada are representative of the total commute/work trips at the two Windsor crossings.
 - The relationship between the residents in the Windsor CMA/employed outside Canada and the crossings they used to commute was maintained between 2001 and the other years (more specifically, that the amount in which the two Windsor crossings have been used by Windsor residents to work in the U.S., relative to each other and to other crossings, has stayed the same).

The following **Exhibit 1** and **Exhibit 2** below, illustrate the historical growth rates in traffic volumes for the entire frontier, for each traffic volume type: same-day passenger vehicles, overnight passenger vehicles, and commercial vehicles, as well as a total count, used as part of this analysis.

Exhibit 1: Historical Crossing Traffic Volumes for the Frontier



Source: Interpreted from Statistics Canada Data

Exhibit 2: Historical Crossings Change in Traffic Volumes for the Frontier

Traffic Volume Type	Year								
	1972 to 2000	1972 to 2008	1972 to 1977	1977 to 1982	1982 to 1987	1987 to 1992	1992 to 1997	1997 to 2002	2002 to 2008
Same-Day Passenger Vehicles	2.48%	0.10%	0.39%	0.55%	3.06%	6.55%	2.75%	-4.72%	-6.01%
Overnight Passenger Vehicles	1.00%	0.50%	0.90%	-1.77%	4.77%	4.24%	-3.75%	5.81%	-5.03%
Commercial Vehicles	5.51%	3.85%	4.86%	-1.05%	11.29%	3.14%	8.57%	4.07%	-2.07%
Total Vehicle Traffic	2.67%	0.79%	0.93%	-0.03%	4.33%	5.70%	2.68%	-1.64%	-4.89%

As indicated in the above exhibits, historical border crossing traffic volumes have vacillated over time, with a general pattern of initial total vehicle traffic increases and a clearly defined peak (around 1999/2000), followed by a contrastingly sharp decline. However, the peak and decline in total vehicle traffic appears to have been primarily caused by the significant peak and subsequent decrease in the same-day passenger vehicle volumes, which accounts for a majority of total vehicular traffic. The other two traffic types exhibited vacillations as well over the same historical time series, although certainly much less pronounced than the same-day crossing market. The same-day passenger vehicle traffic appears to be more historically volatile than the other crossing purposes, indicating that the overnight passenger vehicle crossings and commercial vehicles may be less susceptible to the local influencing factors or economic fluctuations.

As shown in **Exhibit 2**, the total vehicle crossings on the frontier historically grew at an average annual compound rate of 0.79 percent between 1972 and 2008, with varied

average annual compound growth rates among the three traffic subcategories of 0.10 percent, 0.50 percent, and 3.85 percent, for same-day passenger crossings, overnight passenger crossings, and commercial vehicle crossings, respectively. However, the growth patterns are much different when the rates are computed for the historical period prior to the events of September 11, 2001 (1972-2000), during which time, the total vehicle crossings increased annually by 2.67 percent, on average; same-day crossings grew by 2.48 percent, overnight passenger crossings by 1.00 percent, and commercial vehicles by 5.51 percent, on average. There has also been considerable volatility in the average annual compound change over time, with total crossings growing at the fastest pace during the 1980s, and declining by the largest percentage over the decade beginning in the late-1990s.

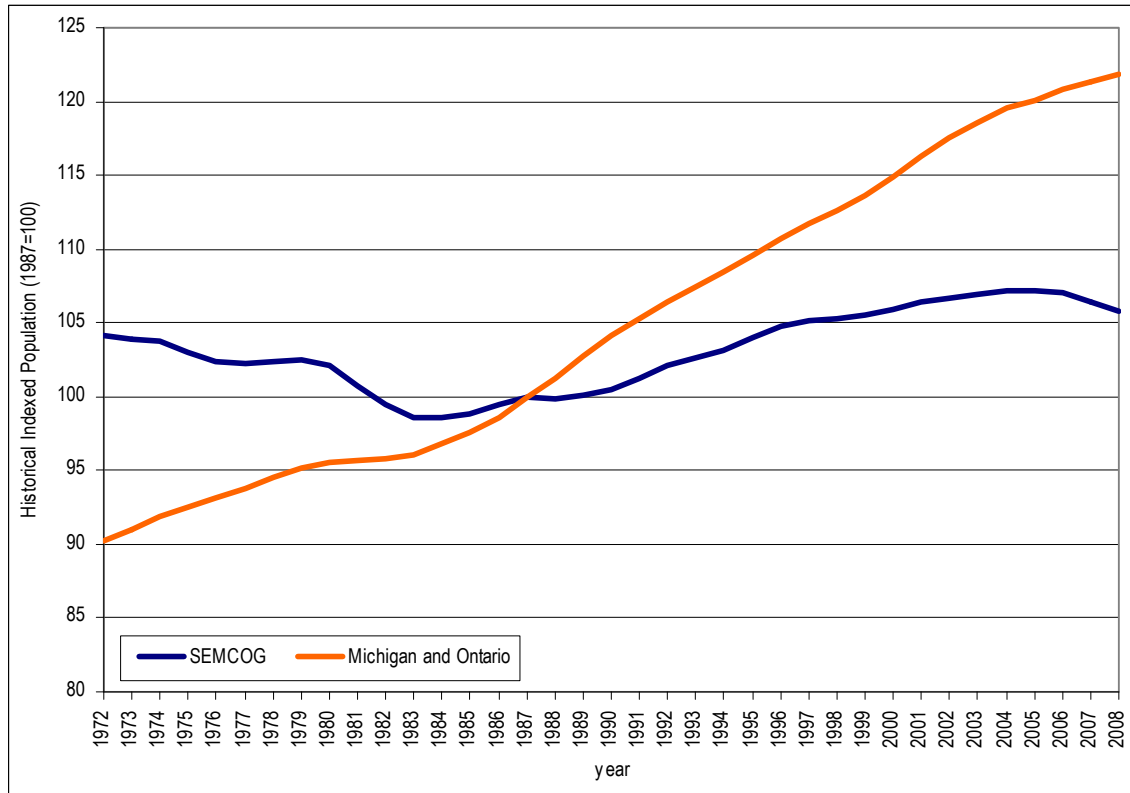
3.2. Historical Trends in the Explanatory Socioeconomic Variables⁴

In the regression analyses, it is assumed that the historical trends in traffic volumes, as presented above, are approximately explained, to a statistically significant degree, by the historical trends in independent socioeconomic variables. The crossing volumes at the three locations are assumed to be a function of the propensity for individuals to drive those vehicles across the border and of the overall number of vehicles. Generally, the number of vehicles available to cross the frontier border is a function of population and/or employment; while the propensity to drive those vehicles across the border is a function of interaction and connectivity, employment levels, disposable income available, trade patterns and other, sometimes less tangible, variables, which may include the exchange rate, tourism attractions, border security, etc.

Identified below in the following three exhibits, are the indexed historical trends in the explanatory independent socioeconomic variables applied in the final regression equations, as detailed further within this documentation. Other less tangible socioeconomic variables as listed previously that were identified as possible explanatory variables were also taken into consideration prior to the determination of the best suited explanatory variables; however, only those variables in the final equations are presented here to provide a historical context for future corridor growth.

⁴ Please see Exhibit 27, in the Appendix for a detailed list of the various sources for the data presented within this subsection.

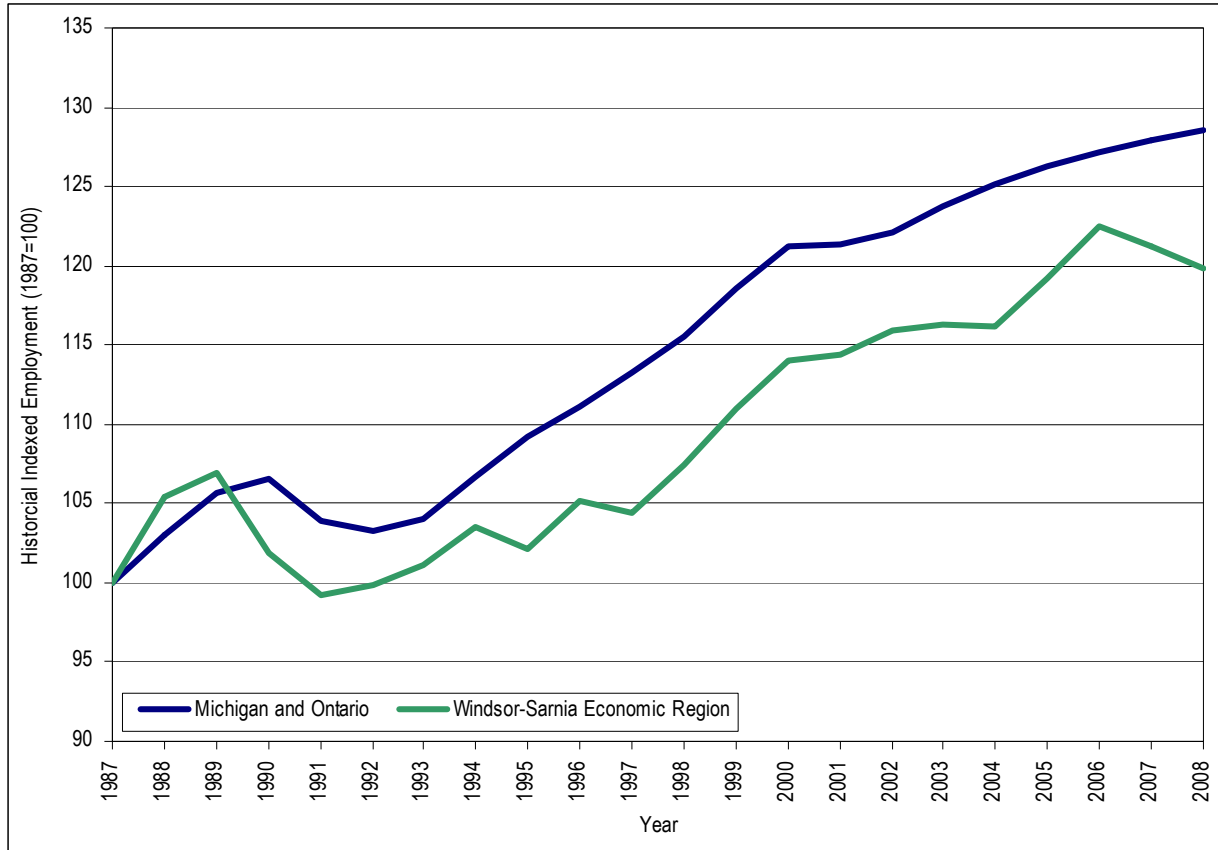
Exhibit 3: Historical Indexed Trends in Population



As shown in **Exhibit 3**, the combined population of both Michigan and Ontario has outpaced the growth in population of the Southeast Michigan Council of Governments (SEMCOG) region, which is a geographic component of Michigan and, in turn, the combined Michigan and Ontario. This indicates that the geographies within Michigan and Ontario, beyond the SEMCOG region, have experienced an appreciably greater rate of population growth than that in SEMCOG region.

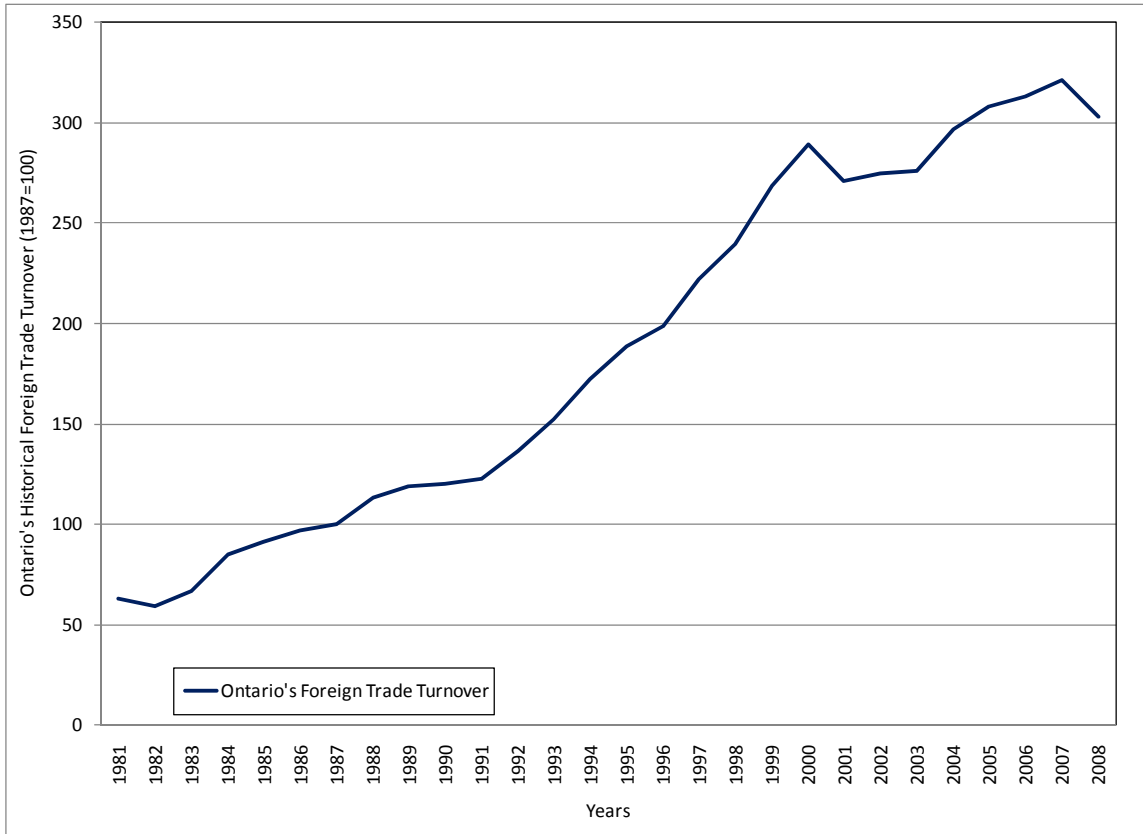
Michigan and Ontario, combined, have increased in resident population, between 1972 and 2008, at an average annual compound growth rate of 0.84 percent, with exhibited relatively constant growth (showing a fairly linear trend). Southeast Michigan Council of Governments region has increased at a much lower average annual compound rate of growth over the same historical timeframe, that is, by only 0.04 percent. SEMCOG has not seen a similarly constant growth over the historical timeframe, with a clearly declining trend from 1972 to 1984, and a rebounding trend thereafter to 2006 (followed by a dip since then).

Exhibit 4: Historical Indexed Trends in Employment



As shown in **Exhibit 4**, employment in the combined geographies of Michigan and Ontario has grown faster than the average annual compound historical growth in population, and has grown at an average annual compound rate of 1.50 percent between 1987 and 2008. Closely paralleling employment growth for Michigan and Ontario, the Windsor-Sarnia economic region experienced an average annual compound rate of 0.87 percent in employment during the same historical time period. Both levels of geography experienced high employment growth between 1991 and 2000 following a slight decline in 1989/1990. The employment since 2000 exhibited a dampened growth for Michigan and Ontario, with the Windsor region exhibiting spiked employment growth between 2004 and 2006, that has since then declined.

Exhibit 5: Historical Indexed Trends in Trade



Ontario’s foreign trade turnover (the sum of merchandise exports plus imports), applied in the truck traffic analysis, increased fairly steadily between 1981 and 2008, with a decline occurring immediately following the year 2000, and again in 2008, as shown in **Exhibit 5**. Between 1981 and 2008 it increased at an average annual compound rate of 6 percent, which is significant in comparison with growth in a number of other economic indicators over that span.

4. Analysis Results (Baseline Scenario)

Based on an evaluation of the historically available corridor data, for both the border crossing traffic volumes and socioeconomic variables, the following subsections present the results of the econometric applications utilized in determining the possible future corridor growth rates for the three types of traffic volumes. In the first three sections, the likely baseline cases for each traffic volume type are presented; alternative high and low corridor growth scenarios are estimated and the results presented within section 4.4.

4.1. Passenger Vehicle (Same-Day) Growth

A distinction is made pertaining to total passenger vehicles crossing the frontier corridors across the Detroit and St. Clair Rivers, based on the duration of the trip. The distinction between same-day and overnight trip durations for passenger vehicle volumes was made

to capture the differing determinate variables that affected the respective markets. Same-day crossings are assumed to be primarily correlated with local socioeconomic variables that include those only within either Michigan or Ontario, while passenger trips crossing the frontier with a trip duration exceeding the same-day are assumed to be a function of socioeconomic variables that extend beyond Michigan and Ontario. In this section, only the multivariate regression econometric results for the same-day passenger vehicle growth rate are presented for the baseline scenario.

4.1.1 Multivariate Regression Analysis Results (Same-day Passenger)

The historical same-day passenger volumes and projected growth rates were first divided into two categories, based on trip purpose: work/commuting crossings and all other crossings (non-work/non-commuting related). A distinction in trip purpose between work/commuting and other crossing types was made because it is assumed that the two trip purposes are derived from different determining factors (similarly to how the total passenger vehicle crossings were subdivided into same-day and beyond same-day crossings). A priori assumptions were made and tested using various multivariate regression equation possibilities for the same-day passenger crossings market segments: work/commuting crossings are assumed to be, fundamentally, a function of employment and population, as work/commuting crossings are likely less susceptible to other potentially influencing factors on border crossing, such as security measures and exchange rate fluctuations, that would have a larger impact on non-work/non-commuting crossing purposes, such as visiting family or friends, shopping and tourism,(all other same-day crossings).

Two separate multivariate equations were calculated to determine the potential growth rates for work/commuting and other crossing same-day passenger purposes that were derived from the different independent socioeconomic variables. In estimating the potential frontier corridor growth for all same-day passenger vehicles, the indexed forecasts of the two differentiated crossing purposes were aggregated (implicitly accounting for the relative weights of the two crossing purposes) and the frontier corridor growth rate calculated from the indexed forecast for all same-day passenger crossings.

Multiple possible socioeconomic variables were tested to determine a statistically significant historical correlation with the border crossing volumes, and following the calculations of multiple multivariate regression equations (calculated with various combinations of the independent socioeconomic variables⁵), one multivariate equation was identified for the frontier and for each traffic volume type, based on the

⁵ Over two hundred multivariate regression equations were modeled with permutations of the independent socioeconomic variables for each same-day passenger vehicle crossing purpose.

socioeconomic variables that exhibited the best explanatory power and based on both qualitative and quantitative assessments of the regression results⁶.

Exhibit 6 illustrates the finalized independent socioeconomic variables identified as significantly correlative with the historical border crossing traffic volumes that serve as the best explanatory variables for two crossing purposes comprising the total same-day traffic volumes. The coefficients and other summary statistics shown in **Exhibit 6** pertain to the same variables as in the previous study but updated with the addition of one more data point – specifically, another year of historical data (2008).

Exhibit 7 illustrates the comparison between the actual historical same-day passenger crossing volumes and those estimated using the multivariate regression equation coefficients. **Exhibit 9** shows the indexed values for the baseline case projection of total same-day passenger vehicle volumes on the frontier, in ten-year increments through 2058, and end year of the future analyzed time horizon, 2064.

Exhibit 6: Explanatory Socioeconomic Variable Coefficients – Same-Day Crossings⁷

Dependent Variable	Independent Variables				adj. R ²	F-stat	
	Population	Employment		Constant			
Border Crossing	SEMCOG	Michigan and Ontario	Windsor Sarnia Economic Region	9/11	b		
Same-day Work/Commute	n/a	6.42 (14.62)	n/a	n/a	-560.73 (-11.09)	91.0%	213.7
Same-day Other	10.92 (6.58)	n/a	-2.91 (-3.72)	-57.07 (-5.39)	-682.47 (-4.66)	88.1%	52.6

* t-statistics corresponding to each coefficient are indicated in the parentheses

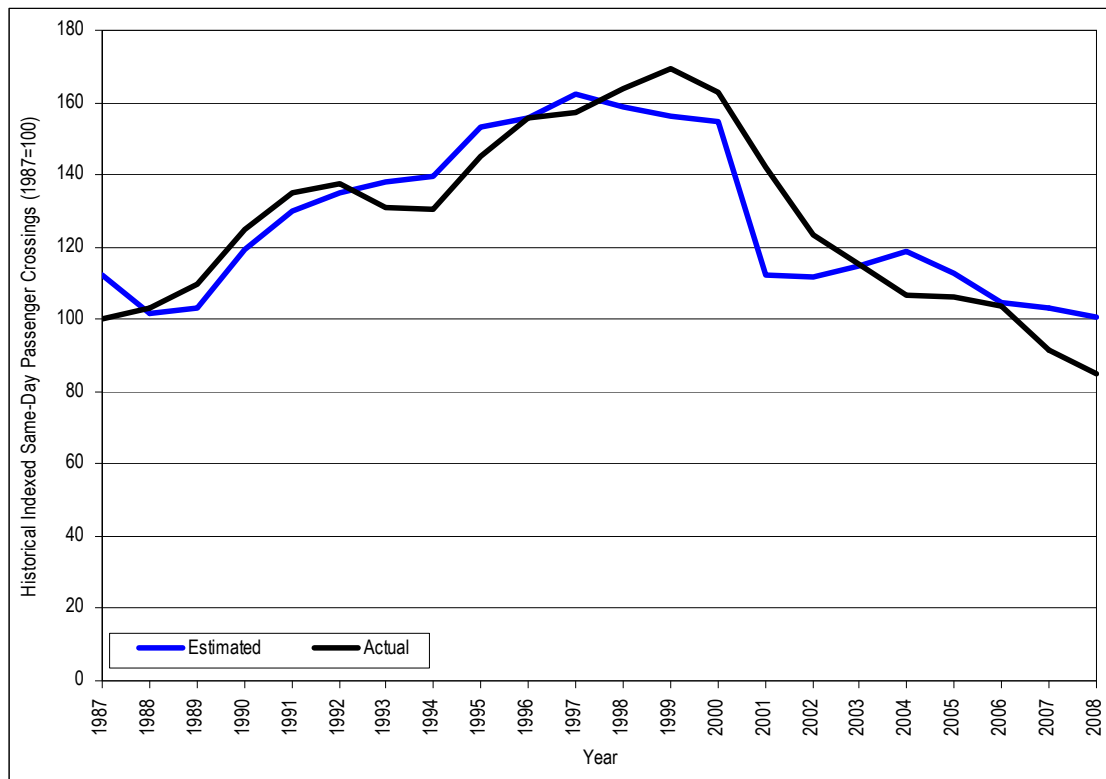
As indicated in the preceding exhibit, both crossing types comprising the total same-day passenger vehicle volumes are correlative with independent population and employment variables, though the variables differ by same-day crossing subcategory. In terms of same-day work/commute crossings, the socioeconomic variable with a significant statistical correlation include the combined employment of Michigan and Ontario. Other same-day passenger crossings are significantly statistically correlated with the population of the SEMCOG region in Michigan and the employment of the Windsor-Sarnia economic region in Ontario. In addition a dummy variable identifying the clearly negative impact of the terrorist attacks that occurred on September 11, 2001 was also used.

⁶ Note that the socioeconomic variable combinations for the multivariate regression equations exhibited a wide range of R² coefficients (i.e., the coefficient of determination, or the mathematically expressed explanatory ability of the independent variables to approximately determine the dependent variable) and the multivariate equation with the highest exhibited R² coefficient was not necessarily deemed as the most appropriate in light of additional qualitative and quantitative assessments of the forecasts. The *t*-statistic measures how many standard errors the coefficient is away from zero such that the higher the *t*-value, the greater the confidence we have in the coefficient as a predictor. Any *t*-value greater than +2 or less than -2 is generally deemed acceptable. The F-statistics provides an indication of the connection between the dependent variable and all or some of the independent variables and tests for statistical significance.

⁷ Multivariate regression coefficients presented within this and the following similar tables are based on indexed values for both the dependent border crossing data and the independent socioeconomic variables.

Regarding same-day work/commuting trip purposes, the combined employment in both Michigan and Ontario was determined to be a significant component in explaining the historical trend in work/commute crossings. Michigan employment, without the Ontario employment, was shown to be a significant explanatory variable; however, for forecasting purposes, the historically predominate directionality of the work/commuting trip may not continue indefinitely and, as such, Ontario employment was aggregated with employment in Michigan to reflect bi-directional work/commute crossings.

Exhibit 7: Actual and Regression Estimated Historical Indexed Same-Day Crossings (1987=100)⁸



Pertaining to same-day other vehicle crossings, SEMCOG population serves to explain a portion of the dependent variable, though is insufficient, alone, to explain the historical growth in the corridor traffic. Employment in the Windsor-Sarnia economic region and the dummy variable pertaining to the effects of September 11, 2001, were also pertinent for explaining the crossing volumes. Windsor-Sarnia economic region employment trends result in a small, albeit negative, coefficient in the final regression equation⁹ as,

⁸ Estimated historical values are the cumulative estimates, as derived from the two regression equations for each same-day passenger subcategory.

⁹ Other independent socioeconomic variables (e.g., Ontario GPP, employment, and population) corresponding to geographies on the Canadian side of the study area were also determined to be significantly explanatory, with a negative regression coefficient, in conjunction with SEMCOG population,

historically, employment changes, generally, moved in the opposite direction relative to same-day other vehicle crossings. Although this directional effect may be counterintuitive, the negative coefficient may be occurring as a result of a few factors, one of which may be: as Canadian residents obtain/retain employment in Windsor-Sarnia, there is a propensity to purchase goods and services, including entertainment, in proximity to the place of employment (convenience and time factors), which may dissuade Canadian residents from crossing the border for trip purposes other than work/commute.

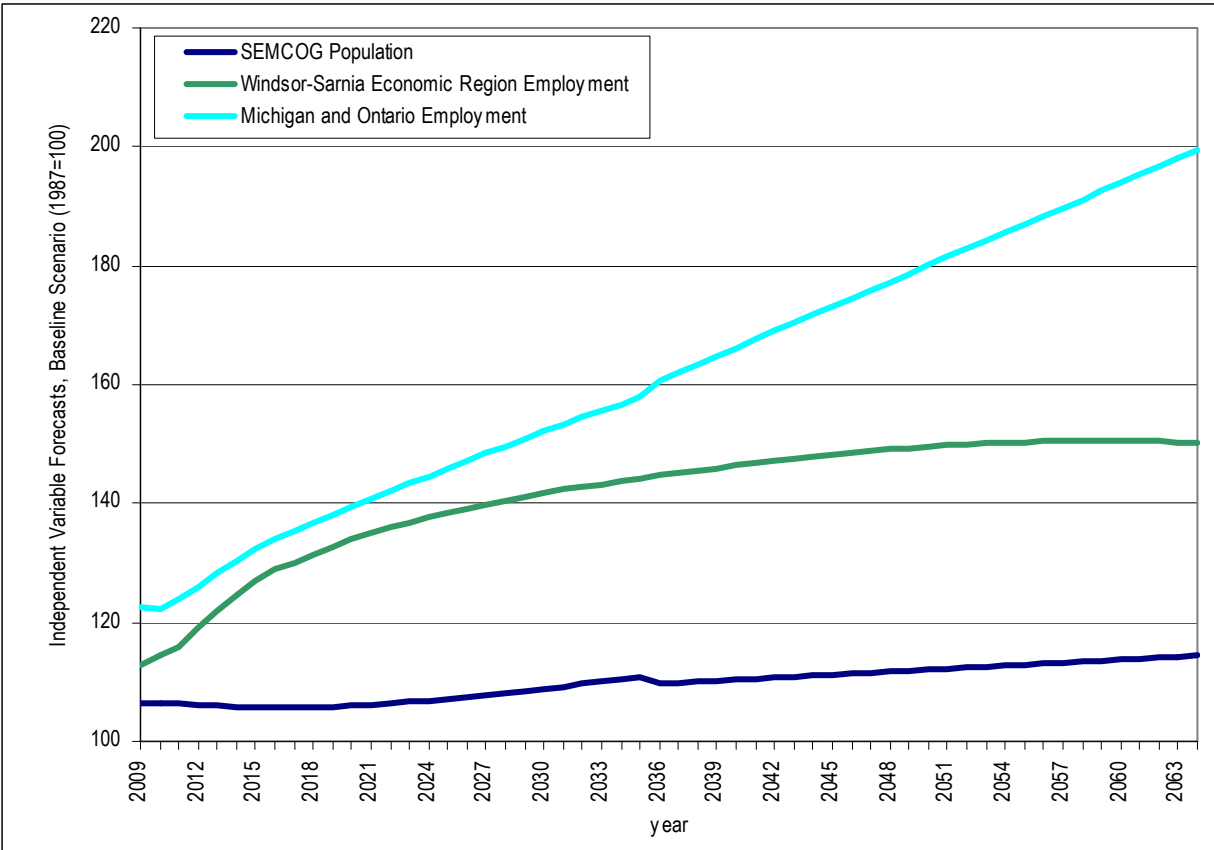
In addition to various population and employment socioeconomic variables pertaining to Michigan and/or Ontario, dummy variables (including the Detroit Casinos, the Windsor Casino, the 9/11 impact, and the impact of the Free Trade Agreement between the United States and Canada), the foreign exchange rate (\$U.S./\$CAD), and the state/provincial gross domestic products (GDP) were also considered as possible historically determinate factors for same-day crossings. However, the various multivariate regression equations indicated that all but the previously mentioned socioeconomic variables were the best suited variables for explaining the levels of total same-day traffic volumes.

September 11, 2001 was a shocking event with extraordinary ramifications for international border crossings, not only in terms of the immediate reduction in crossings, but also in terms of ongoing existing and perceived institutional security-related restrictions pertaining to both commercial and passenger movements. It is this event and the ensuing consequences that have negatively influenced cross-border movements, particularly for discretionary non-work/non-commuting passenger crossings. No foreseeable easing or removal of these implemented restrictions is evident, at least within the immediate foreseeable future.

An underlying assumption was made pertaining to the future developments related to the continuing aftermath of the event. The effect of the event is assumed to transpire throughout a generational span (assumed to progressively decline until becoming non-influential by 2034; i.e., the dummy variable progressively declines to the value of 0).

though employment for the Windsor-Sarnia economic region was determined as best suited explanatory variable of those attempted.

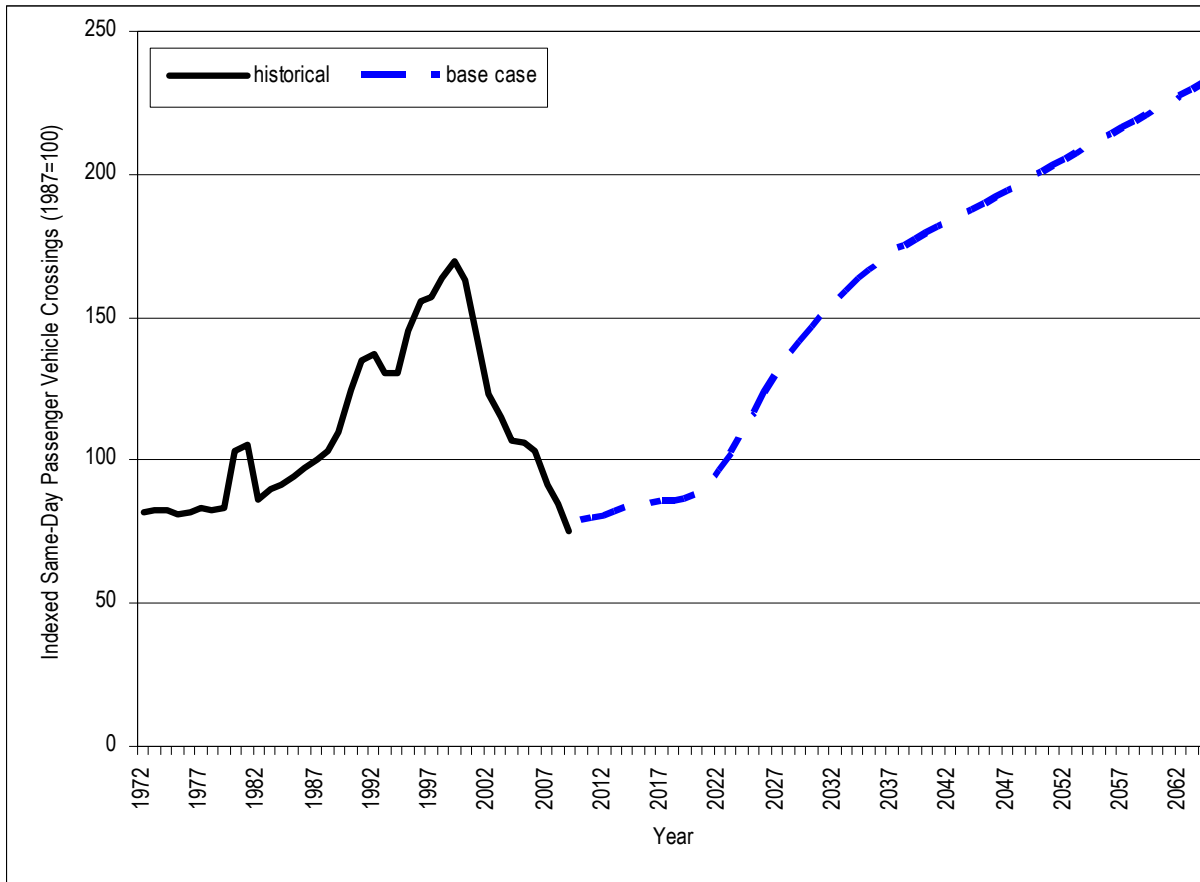
Exhibit 8: Independent Variables Forecasts (Baseline), Same-Day Crossings



The forecast corridor growth for those traffic volumes was determined by applying the forecast values of the independent socioeconomic variables, following an assessment of all the multivariate regression equations and final identification of the most appropriate proxy determinates of the two same-day passenger vehicle crossing types, as shown in **Exhibit 8**. **Exhibit 9** illustrates the estimated future growth for the total same-day passenger vehicle volumes across the frontier under the baseline case. Alternative forecast scenarios, for the same-day crossings demand are presented in section 4.4.1. An identification of the source data for the independent socioeconomic variable forecasts is provided within **Exhibit 27**, as along with an indication of the assumptions made in developing these forecasts.

Exhibit 9: Indexed Forecast Corridor Growth for Baseline Scenario: Same-Day Passenger Vehicle Crossings (1987=100), Selected Years¹⁰

Border Crossing Type	Scenario	Years						
		2008	2018	2028	2038	2048	2058	2064
Same-Day Passenger	Baseline Case	85	86	137	175	196	218	231



According to the preceding exhibit, the calculations for the baseline case corridor growth on the frontier for same-day passenger vehicles increases from an indexed value (1987=100) of 85 in 2008 to 231 in 2064, an increase of 2.7 times and with a corresponding average annual compound growth rate of 1.80 percent.

4.2. Passenger Vehicle (Overnight) Growth

Overnight passenger vehicle crossings accounted for about 19 percent of all annual passenger car crossings between 1972 and 2008 (with some fluctuations). In recent years this share has grown to more than 22 percent. There has not been a substantial increase in

¹⁰ In the multivariate regression equations chosen for same-day passenger crossings, the historically available data for some of the explanatory socioeconomic variables was provided only from 1987; thus, the regression equation extends only that far back in time.

actual overnight crossings, however; the overnight share increase can be attributed to the recent sharp decline occurring in same-day crossings.

4.2.1 Multivariate Regression Analysis Results

Overnight passenger vehicle crossings exhibit a generally steady upward trend across the entire historical period (1972 to 2008); however, overnight crossings showed a temporary trend above this between 1991 and 1993, and then fell below this trend from 1996 through 2000. Between 2000 and 2005 overnight passenger crossings once again followed a generally upward trend, but then paused in 2006 and fell once again in both 2007 and 2008.

A number of key variables were considered as potential factors in determining the variation in overnight passenger crossings over this period. These include the populations of Michigan and Ontario, real GDP of Michigan and Ontario, employment in Michigan and Ontario, the rate of exchange between the U.S. and Canadian dollars, and the dummy variable for 9/11. Various pairings of the above variables were tested using multiple regression analysis. In the end, it was found that the greatest explanatory power of historical overnight vehicle crossings came from using the combined populations of Michigan and Ontario (this variable explained 68 percent of the variation), but none of the other variables explained the brief rise above and fall below the long term trend.

An attempt was made to explain changes in the overnight share using the exchange rate. This avenue proved successful in that the exchange rate was found to explain about 92 percent of the variation in the share of overnight crossings. However, plots of the estimated to the actual values revealed that the dip in the share that occurred in the latter half of the 1990s was not explained. This estimation was therefore dismissed since the estimation of respective same-day passenger crossings was already disaggregate in nature and better accounted for the share distributions.

An equation explaining overnight passenger trips using the combined populations of Michigan and Ontario was estimated to be the best explanatory variable to predict the long-term potential for crossings of this type. The table in **Exhibit 10** below presents the regression coefficients for this type of crossing, and **Exhibit 11** plots the actual and regression estimated indexed values for the overnight passenger crossings.

The equation described here estimates overnight passenger crossings in 2009 at 3.47 million whereas data available to date in 2009 (the first ten months) suggests the total for the year will come in at only 2.48 million. The equation overestimated the actual number in each of 2008 and 2007, as well, by a growing amount. The now expected actual value for 2009 is only about 70 percent of its estimated value based on the known populations of Michigan and Ontario in 2009.

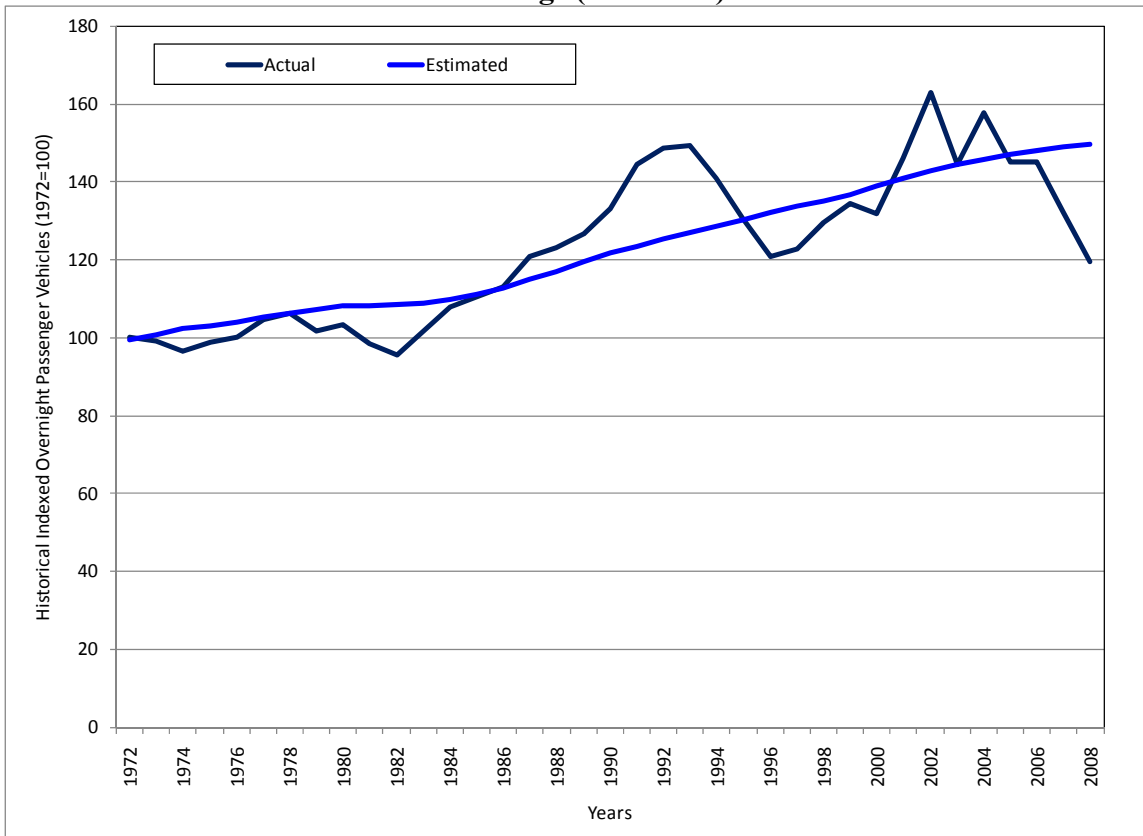
Many observers believe this 30 percent gap will continue well into the future. The numerous measures put in place in the post-911 environment – especially the recent passport requirements – are seen to have permanently reduced the attractiveness of cross border travel for many citizens on both sides of the border.

Exhibit 10: Explanatory Socioeconomic Variable Coefficients – Overnight Crossings¹¹

Dependent Variable	Independent Variables		adj. R ²	F-stat
	Population	Constant		
Border Crossing	Michigan and Ontraio	b		
Overnight Passenger	1.43 (8.74)	-43.98 (-2.29)	67.7%	76.4

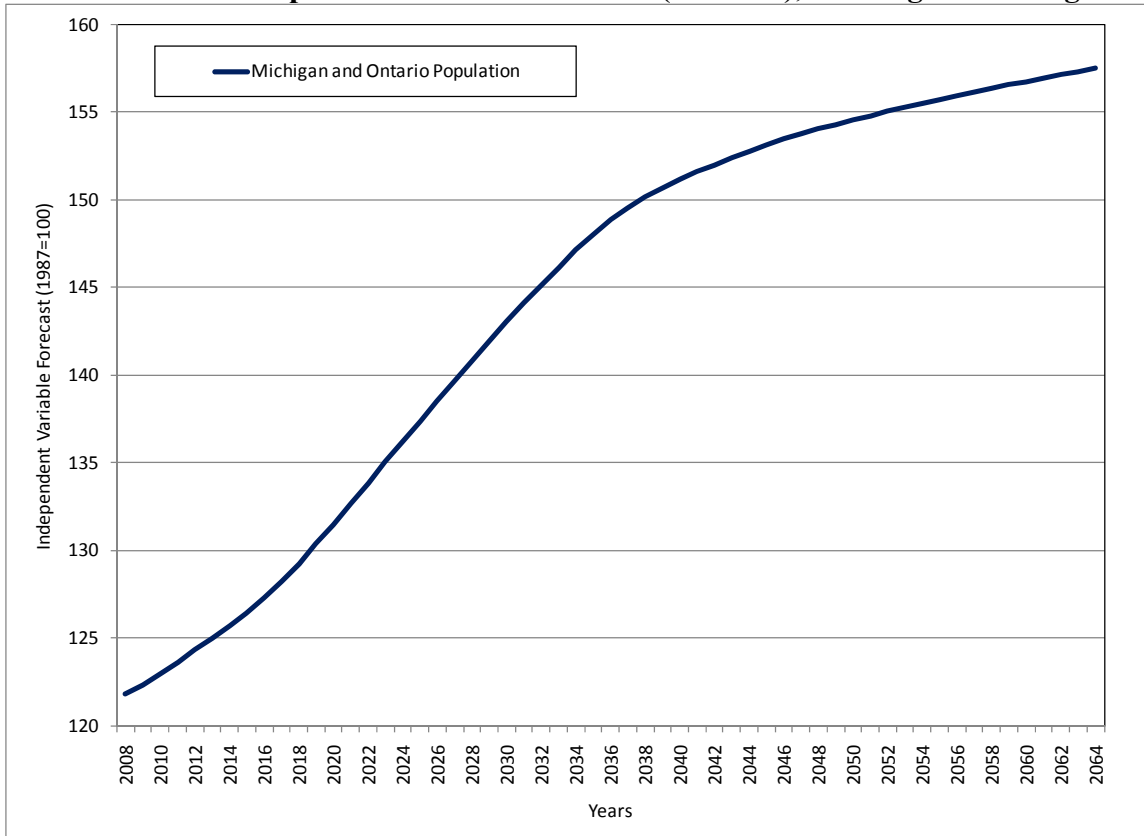
* t-statistics corresponding to each coefficient are indicated in the parentheses

Exhibit 11: Actual and Regression Estimated Historical Indexed Overnight Crossings (1972=100)



¹¹ Overnight passenger vehicle crossing regression equations were calculated, and the ensuing coefficients, corresponding to indexed values for the historical crossing and independent explanatory socioeconomic variables for a base year 1972, i.e., 1972=100; however, the forecasted vehicle crossings are indexed with the base year 1987, i.e., 1987=100, for consistency with the same-day passenger vehicles.

Exhibit 12: Independent Variable Forecast (Baseline), Overnight Crossings

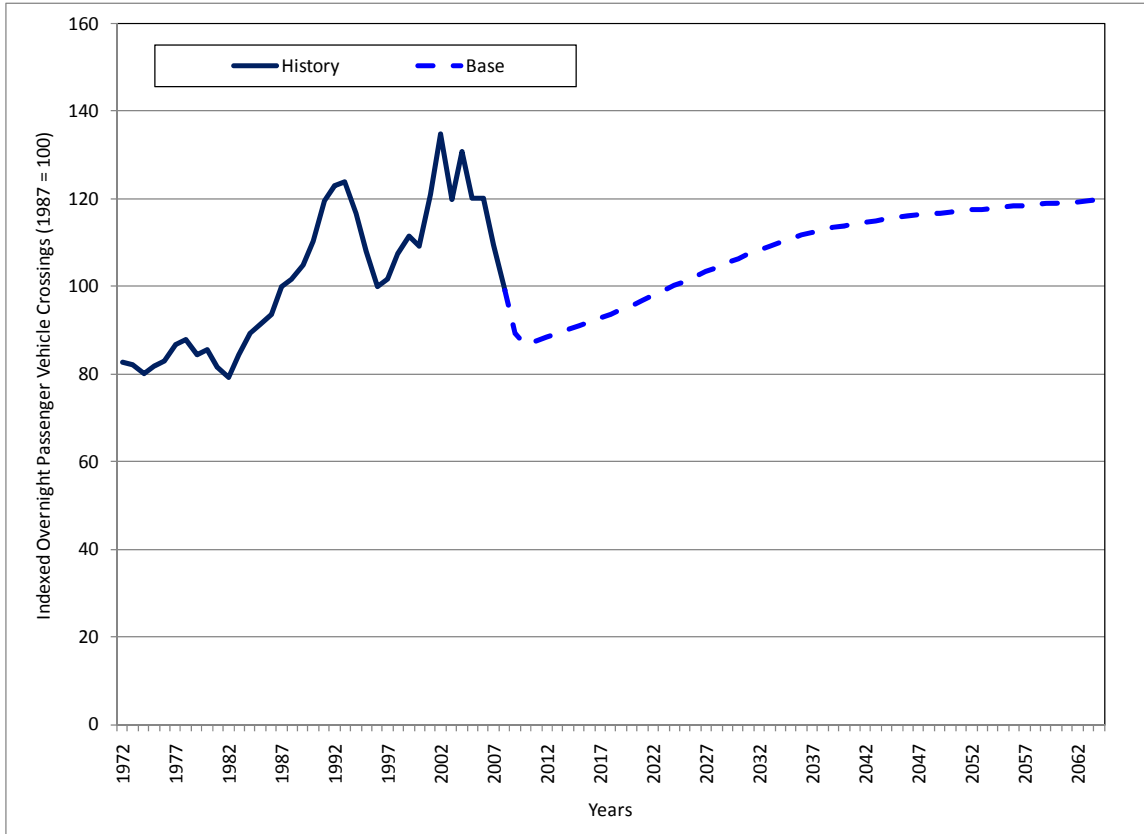


The forecasted indexing of corridor growth for overnight passenger crossings was determined by applying the forecast values of the independent variable (the indexed values of the combined total population of both Michigan and Ontario), as shown in **Exhibit 12**, with an adjustment to the projected results to reflect the reduction of 30 percent of future crossing that will continue to be deterred by the cross border security measures. **Exhibit 13** illustrates the estimated future baseline growth along the frontier for overnight passenger vehicle crossings using the equation adjusted to reflect the security measures dampened impact. Future growth in overnight passenger vehicle crossings is determined beginning with 2010 as the base year growing in the future at a rate determined by population growth.

Alternative forecast scenarios for overnight passenger vehicle crossings are presented in section **4.4.3**.

Exhibit 13: Indexed Forecast Corridor Growth for Baseline Scenario: Overnight Passenger Vehicle Crossings (1987=100), Selected Years

Border Crossing Type	Scenario	Years						
		2008	2018	2028	2038	2048	2058	2064
Overnight Passenger	Baseline Case	99	94	104	113	117	119	120



According to the preceding exhibit, overnight passenger vehicles decreased from an indexed value (1987=100) of 99 in 2008 to 89 in 2009 (based on data available for the first 10 months of the year), and are expected to further fall to 87 in 2010 before climbing slightly again through the recovery period, reaching 94 by 2018. Overnight passenger vehicles then gradually increase through the remainder of the projection period, ultimately reaching 120 by 2064. Between 2008 and 2064 overnight passenger vehicles increase 1.2 times at a corresponding average annual compound growth rate of 0.34 percent.

4.3. Commercial Vehicle Growth

In 2007 and 2008 commercial vehicles accounted for about 27 percent of all vehicle crossings along the frontier. Commercial vehicle crossings across the frontier have significantly grown in importance over the last quarter century from about 11 percent in the early 1970s and 15 percent in the late 1980s. This growth, especially that occurring

since the early 1990s, stems from the strong impact on two-way trade between the United States and Canada resulting from the enactment of the Auto Pact in 1965 and the Free Trade Agreement (FTA) and North American Free Trade Agreement (NAFTA) in the late 1980s and early 1990s, respectively.

4.3.1 Multivariate Regression Analysis Results

Most of the frontier commercial vehicle traffic reflects long distance trips; with only a small portion representing the local-to-local trips. Data regarding the local-to-local share of the total commercial trips is not available for the entire historical period, however, survey data¹² for 2000 indicated that the local-to-local crossings accounted for 17 percent of all commercial vehicle crossings. The local-to-long distance trips accounted for 31 percent (including both from Windsor to a U.S. destination and Detroit to a Canadian destination) and the long-distance to long-distance trips accounted for the remaining 52 percent.

The same survey suggests that trade between the U.S. and Canada in motor vehicles and parts accounted for about one-third of all commercial vehicle crossings in 2000. Given that Michigan and Ontario are the major producers of both automobiles and parts in the U.S. and Canada, respectively (Michigan accounted for 22.1 percent of all U.S. motor vehicles and parts production in 2008 while Ontario accounted for 66.6 percent of all Canadian production), it is not surprising that local-to-local and local-to-long distance crossings are an important component of all commercial vehicle crossings in the area.

Trade patterns between the two countries have changed over time, however. For example, automotive products as a share of total Canadian non-energy exports averaged 26 percent between 1971 and 2008 (with considerable year-to-year cyclical variation over that span), but in recent years they have fallen below that average (to 23 percent in 2006, 22 percent in 2007 and 17 percent in 2008). Canadian exports of industrial goods and of machinery and equipment grew faster than automotive exports over that period, both reaching a total share of exports by 2006 greater than Canada's exports of automotive products. Canada's exports of consumer goods also grew faster, although their share remains much lower than that of the automotive products.

The spatial dimensions of automotive product production in the U.S. and Ontario are also changing. On the U.S. side, Michigan's relative importance is also in decline. According to U.S. Energy Department data Michigan's 22.1 percent share of national automobile production in 2008 was down 6.5 percentage points, from 28.6 percent in 1997. Over that period, the top four states retained their relative rankings (with Ohio, Indiana and Kentucky following Michigan) but Alabama moved from 19th to 5th and Louisiana from 34th to 14th within the U.S., while New York fell from 8th to outside of the top 20 and Georgia fell from 9th to 17th. On the Canadian side, the relative importance of Windsor has declined, as both North American and overseas producers increasingly locate new production sites in the Greater Toronto Area's suburbs and along the province's major highway system.

¹² *Existing and Future Travel Demand*, IBI Group, January 2004, page 54, referencing the NRS/MTO commercial vehicle survey database

The current recession undoubtedly altered the product and spatial dimensions of U.S.-Canada trade further in 2009 along the lines described above. It can be expected in the future that the automotive share of the trade totals will continue to decline and that automotive production will continue to move away from Detroit and Windsor. Thus, the local-to-local share of commercial vehicle crossings can be expected to decline in the decades ahead.

In view of the historical trends, it was expected that the volume of trade between the United States and Ontario would prove to be the most important historically determinate factor for commercial vehicle trips. Other variables – including the exchange rate and the dummy variable for 9/11 – were considered. Regression analysis as summarized in **Exhibit 14** proved the merit of this premise; a very high percentage of the variation over time in commercial vehicle crossings is explained by the volume of Ontario’s merchandise trade turnover (the sum of exports plus imports) with other countries (most of it with the U.S.), although the U.S. /Canada exchange rate was also found to contribute. **Exhibit 15** below compares the actual and estimated indexed values of the commercial vehicle crossings over the period. It is worth noting that this equation predicts that commercial vehicle crossings will grow in the future at a rate a bit slower than the rate of growth in Ontario’s trade turnover over the same period. In other words, the equation implicitly reflects the significant shifts in the types of materials traded between the U.S. and Canada over the last several decades – the shift away from automotive toward machinery and equipment and industrial materials – and incorporates the expectation that shifts of equal magnitudes will occur in the future. The expected slower commercial vehicle pace compared to trade values, in other words, reflects numerous factors, including the long-term shift in the mix of goods being transported and improvements in transportation productivity.

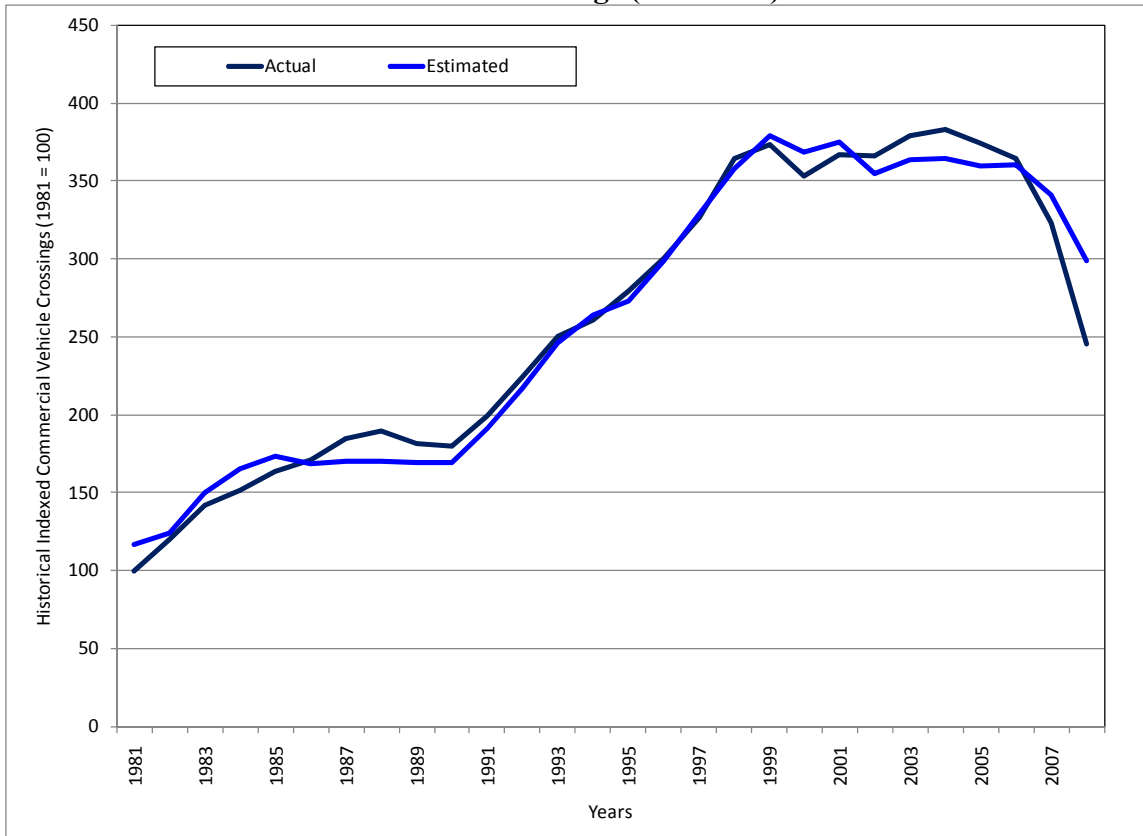
Exhibit 14: Explanatory Socioeconomic Variable Coefficients – Commercial Vehicle Crossings¹³

Dependent Variable	Independent Variables			adj. R ²	F-stat
	Trade	Foreign Exchange	Constant		
Border Crossing	Ontario's Foreign Trade Turnover	Canada/US	b		
Commercial Vehicles	0.59 (29.42)	1.52 (5.85)	-95.02 (-3.43)	97.2%	469.2

* t-statistics corresponding to each coefficient are indicated in the parentheses

¹³ Commercial vehicle crossing regression equations were calculated, and the ensuing coefficients, corresponding to indexed values for the historical crossing and independent explanatory socioeconomic variables for a base year 1981, i.e., 1981=100

Exhibit 15: Actual and Regression Estimated Historical Indexed Commercial Vehicle Crossings (1981=100)



Few forecasters develop long-term projections of Ontario’s trade turnover, particularly to the projection horizon required by this assignment (to 2064). In view of the importance of this variable in explaining variations in commercial vehicle crossings, a method is required to explain Ontario’s trade turnover based on variables that are more widely projected and readily available.

Ontario’s largest customer for exports of merchandise is the United States. In recent years the U.S. has accounted for more than 80 percent of Ontario’s goods exports and more than 60 percent of its goods imports¹⁴. While automobiles and automobile parts account for a significant share of that two-way trade – upwards of one-third or more in both directions – other products are also important, including medications, raw materials, furniture and communications equipment. Additionally, while Michigan is the number one destination and origin for Ontario’s U.S. exports and imports, respectively – accounting for one-third of Ontario’s U.S. exports and one-sixth of its U.S. imports in 2007 – other states are also major trading partners for Ontario¹⁵.

¹⁴ Shares are based on data obtained by C4SE from *Ontario Facts*, a website compiled by the Ontario Ministry of Economic Development and Trade (see <http://www.2ontario.com>).

¹⁵ Ibid.

The top 10 states trading with Canada (Quebec is the 3rd largest province in U.S. Trade and the Maritime Provinces rank 7th through 10th) as a whole in 2008 and transported via surface modes of transportation¹⁶ (Trucks, Trains, and Pipelines) were: Michigan \$67.041 Billion; Illinois \$52.329 billion; New York \$36.485 billion; Ohio \$34.124 billion; California \$31.915 billion; Texas \$28.878 billion; Washington \$23.349 billion; Pennsylvania \$21.535 billion; Minnesota \$19.395 billion, and Indiana \$15.758 billion.

The top ten U.S. destinations for Ontario's exports on a state-by-state basis, after Michigan in 1st place, include California (ranked 2nd), Ohio (4th), Illinois (5th), Texas (7th), Indiana (8th) and Georgia (10th). Trucks from Ontario heading for these destinations are likely to enter the U.S. by traversing one of the crossings along the frontier. Exports from Ontario to its other major U.S. destinations (New York, ranked 3rd), Pennsylvania (6th) and New Jersey (9th) are likely to cross via the Niagara River or other crossings. The top ten states account for three-quarters of Ontario's exports to the U.S., with most of the rest of Ontario's exports scattered throughout the rest of the nation.

Since seven of the top ten export destinations are served by the international crossings located on the frontier (as, most likely, also including the widely dispersed Ontario exports to the U.S.), it is no surprise that the Ambassador Bridge, Blue Water Bridge and Detroit-Windsor Tunnel, collectively, accounted for about 57 percent of Ontario's total cross-border truck traffic in 2000¹⁷. In other words, while Michigan is important to Ontario as an export destination and as an import origin, it is just one of many states with which Ontario carries on two-way trade. Thus, Ontario's foreign trade turnover is likely more related to U.S. GDP as a whole rather than to just Michigan's GDP.

Views among the long-term macroeconomic forecasters are surprisingly diverse on the potential for the future growth of the U.S. economy. In view of this, and considering the wide dispersion of Ontario's trade turnover on a state-by-state basis, it was considered prudent here to develop a framework that establishes a strong direct link between Ontario's trade turnover and real U.S. GDP. It was not considered prudent to develop a framework requiring state-by-state economic projections, which are few and far between, and which would exhibit even greater dispersion than the long-term forecasts for the U.S. as a whole.

The environment within which Ontario has traded with the United States has changed in significant ways over the last 35 years with the most important influences including the following: growth in the economies of the U.S., Canada, Michigan and Ontario; enactment of the FTA and NAFTA in the late 1980s and early 1990s, respectively; fluctuations in the exchange rate between the U.S. and the Canadian dollar; and, terrorist attacks in 2001, and the ensuing impacts of 9/11 on the processing of cross-border traffic. Of these recent influences, the study team expected that the foreign exchange rate between the U.S. and Canada and the impact of 9/11 might prove to be important variables in explaining Ontario's real trade turnover. Regression analysis revealed that

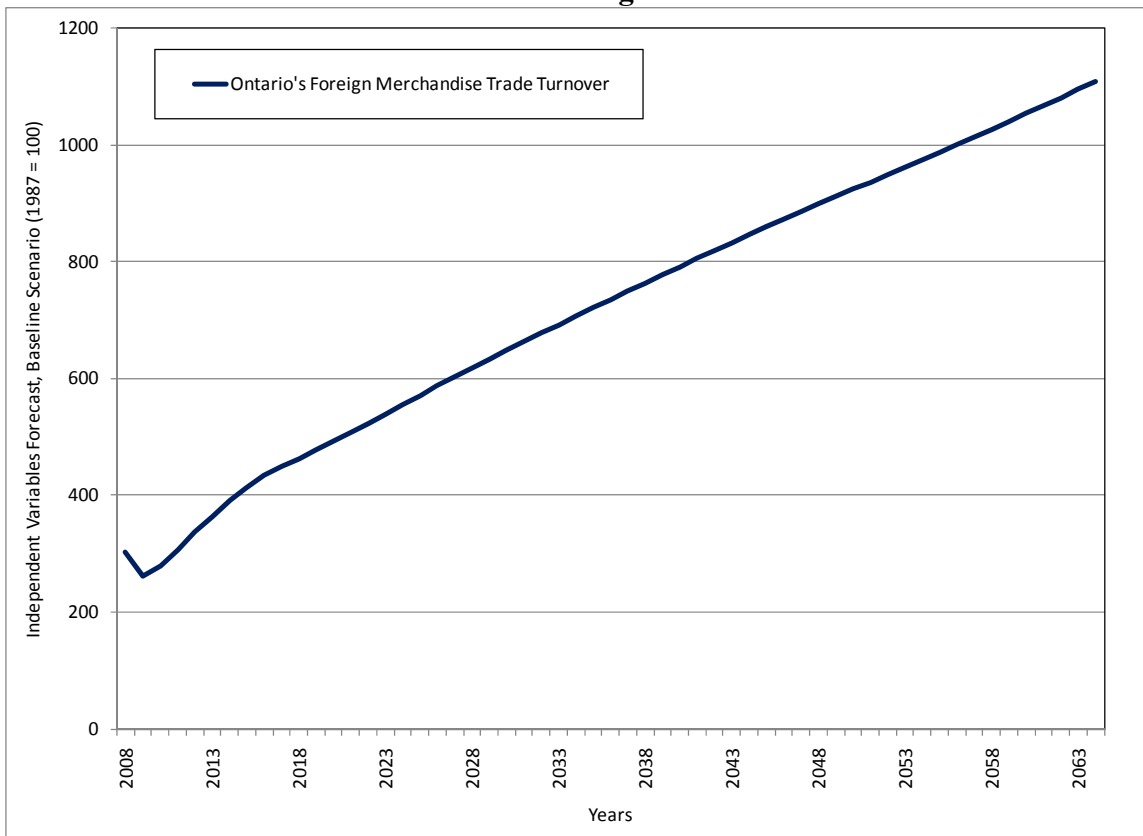
¹⁶ Source: Bureau of Transportation Statistics – North American Surface Trade

¹⁷ Source: IBI Group study in 2004

all three variables – U.S. real GDP, the exchange rate, and the aftermath of 9/11 – were statistically significant in explaining Ontario’s trade turnover with other countries.

For the purpose of preparing the projections in this report, Transport Canada provided the Centre for Spatial Economics (C4SE) with long-term projections for the U.S., which they recently acquired from the Conference Board of Canada, Informetrica, and Global Insight. However, upon an assessment of these different projections¹⁸, the U.S. GDP long-term forecasts internally developed by C4SE were applied to the derivation of the trade turnover in Ontario, and, consequently, the commercial vehicle demand growth along the frontier corridor. **Exhibit 16 illustrates** the projected long-term trendline growth in Ontario’s foreign trade turnover, which serves as the determinate variable for commercial vehicle crossings.

Exhibit 16: Independent Variable Forecast (Baseline), Commercial Vehicle Crossings



Recent data suggest that Ontario’s trade turnover declined by 5.7 percent in 2008 and data for the first six months of 2009 suggest a further decline in the order of 13 to 14 percent is in order for the year as a whole. Thus, Ontario’s trade turnover declined by

¹⁸ This examination and comparison of the macroeconomic projections developed by different forecasters will be presented as part of the subsequent risk assessment task of this study.

almost 20 percent between 2007 and 2009. Between 2007 and 2009 commercial vehicles declined by more than 30 percent. The difference in rates suggests that the shift in the mix of merchandise trade due to the recession – the share for transportation equipment and parts likely fell significantly between 2007 and 2009 – meant fewer commercial vehicles were required per dollar volume of trade in 2009 compared to 2007.

The short term macro-economic forecasts used to generate the near term changes in trade turnover all suggest significant growth in the U.S. economy in the next several years (see the see **Exhibit 21** below), each of which implies Ontario's trade turnover will grow rapidly over this period. While the automotive sector is not expected to return to its pre-2007 levels of production it is expected to improve along with the rest of the economy at above long-term potential growth rates simply because it has fallen so much in the last two years. Any improvements over the current low levels of production and trade activity generate large percentage gains. One of the U.S. forecasts considered in the risk assessment chapter, for example, expects total U.S. trade turnover to grow by about 6 percent in 2010, by 10 percent in 2011 and by another 8 percent in 2012 after falling by about 14 percent in 2009, or by a cumulative increase of more than 25 percent from 2009 to 2012.

Swings in growth of this magnitude in trade turnover imply similar significant swings in the growth of commercial vehicles across the frontier, especially considering the significant shift in the mix of transported goods that will also occur over that period (at least partly reversing the shift in mix occurring between 2007 and 2009). **Exhibit 17** compares the level of Ontario's trade turnover in index form (with 2005 = 100) to the level of commercial vehicle crossings also in index form (with 2005 = 100). The short-term segment of the projections in this report imply that by 2012 Ontario's trade turnover exceeds its level in 2005 by almost 10 percent whereas commercial vehicle crossings by 2012 are just barely back to where they were in 2005.

According to the following exhibit, commercial vehicle crossings are estimated to have fallen due to the current recession from an indexed value (1987 = 100) of 190 in 2008 to 144 in 2009, then to gradually recover the lost ground from the recession over the next few years ultimately reaching 698 in 2064, an increase of 3.7 times between 2008 and 2064 with a corresponding average annual compound growth rate of 2.35 percent.

**Exhibit 17: Indexed Actual and Forecast
Ontario Trade Turnover and Corridor Commercial Vehicle Crossings,
2005 to 2012 (2005 = 100)**

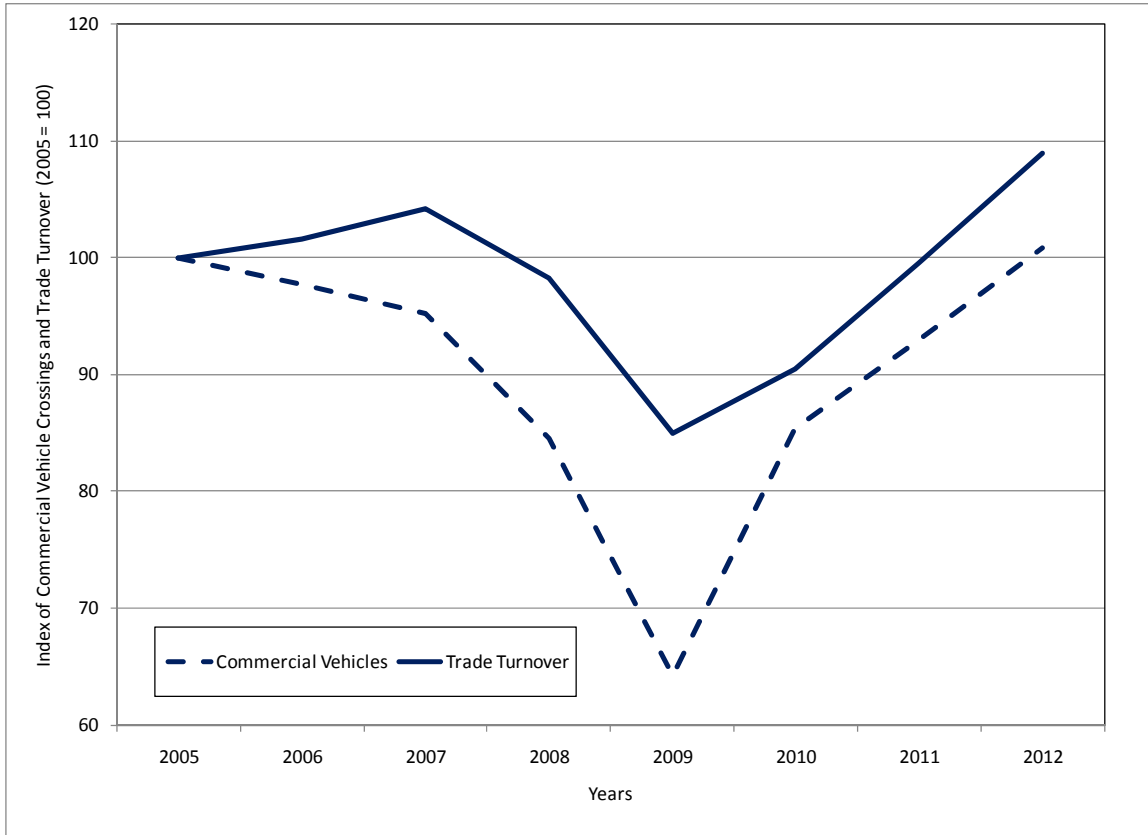
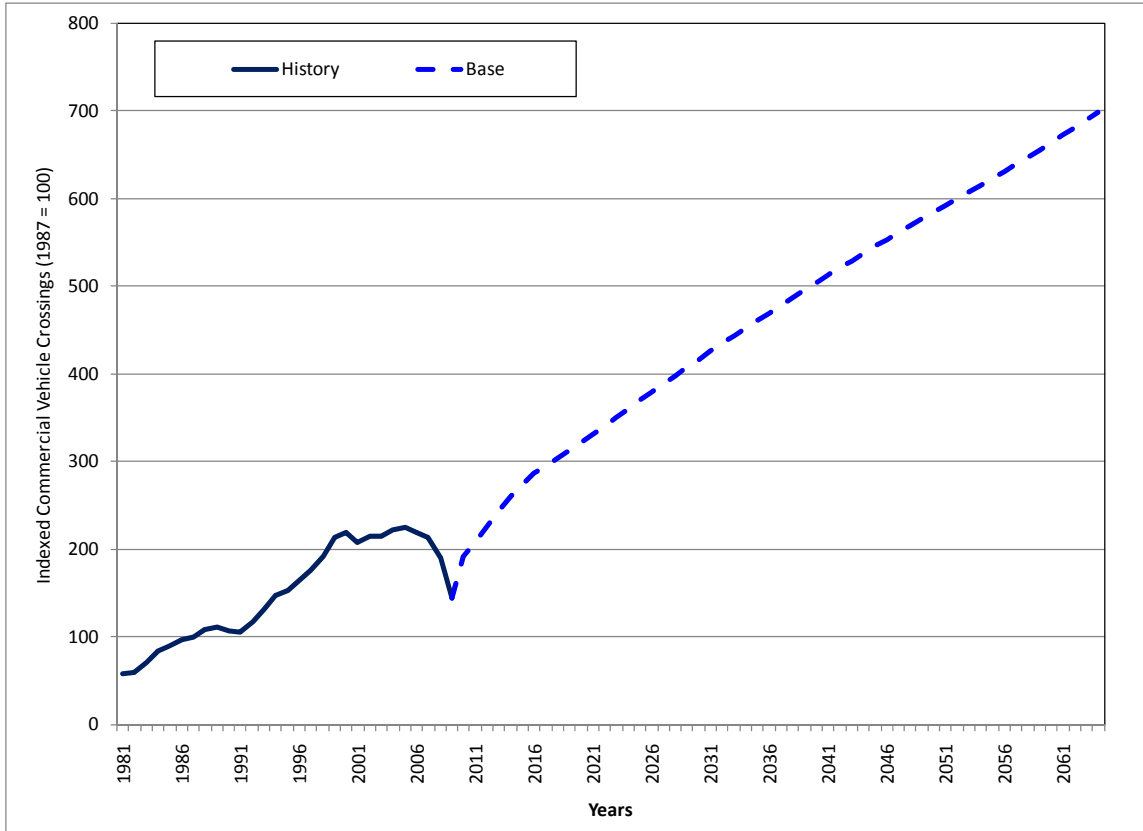


Exhibit 18: Indexed Forecast Corridor Growth for Baseline Scenario: Commercial Vehicle Crossings (1987=100), Selected Years

Border Crossing Type	Scenario	Years						
		2008	2018	2028	2038	2048	2058	2064
Commercial Vehicles	Baseline Case	190	304	398	487	569	647	698



4.4. Alternative Scenarios – Projections Envelope

While the baseline case scenario is often used to express the most likely anticipated growth, actual growth may fluctuate above and/or below this estimate because of variations in the anticipated values of the explanatory variables applied to determine the growth. Consequently, alternative forecast scenarios were also conducted to gauge the potential range of border crossing growth projections.

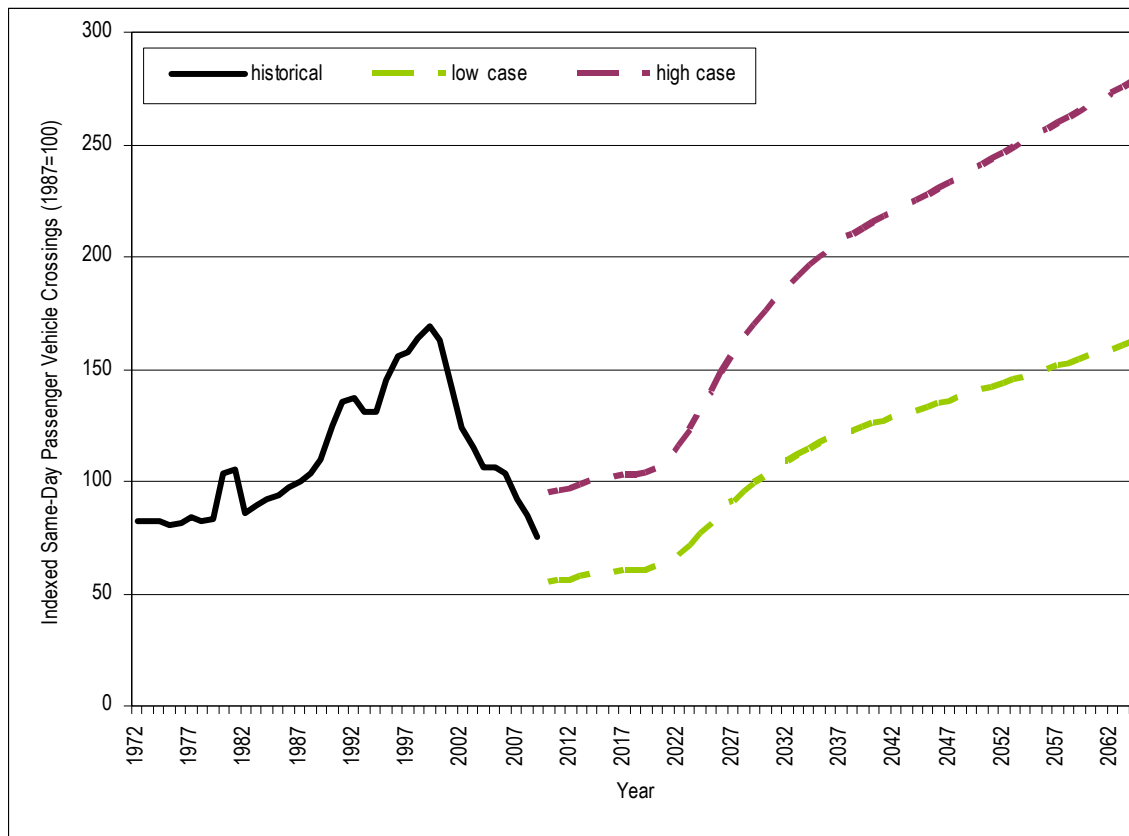
4.4.1 Passenger Vehicle (Same-Day) Growth Scenario Alternatives

Alternative (low or pessimistic, and high or optimistic) growth scenarios forecast for the same-day passenger crossings demand are developed by applying up (20 percent) and down (30 percent) extensions to the baseline growth scenario, effectively formulating a projections envelope.

Indicated within **Exhibit 19** are the alternative low and high forecast scenarios pertaining to same-day passenger vehicle crossings along the frontier. As exhibited, in the low case forecast scenario, same-day passenger crossings are forecasted to appreciate by year 2064 to 1.9 times the level forecasted in 2008, increasing from an indexed value of 85 to 162; with a growth rate of 1.15 percent, on average, per annum. Contrastingly, the high forecast scenario predicts as appreciation in same-day passenger vehicle crossings of 3.26 times the traffic levels of 2008 by 2064, from an indexed level of 85 to 278, appreciating at an average annual compound growth rate of 2.13 percent.

Exhibit 19: Indexed Forecast Corridor Growth for the Alternative Scenarios: Same-Day Passenger Vehicle Crossings (1987=100), Selected Years

Border Crossing Type	Scenario	Years						
		2008	2018	2028	2038	2048	2058	2064
Same-Day Passenger	Low Case	85	60	96	122	137	153	162
Same-Day Passenger	High Case	85	103	164	210	235	262	278



4.4.2 Long Term Projections and Risks

The Centre for Spatial Economics developed the equations used for projecting overnight passenger vehicle and commercial vehicle crossings, and developed the alternative projections for each of these two variables. Before discussing the alternative projections,

it is useful to discuss how the base case projections for several of the key drivers were produced.

At the outset of this discussion, it is useful to note that it is standard practice among long-term economic forecasters to develop base case (and low and high projection alternatives) that reflect expectations regarding the *underlying trend* in economic activity that is likely to occur in the future. Projections of *cyclical variations above and below the expected underlying trend* are typically not prepared over the long-term, as it is impossible to predict the future dates of peaks and troughs in activity. Trend projections are developed with the knowledge that economic cycles will continue to occur. However, it makes sense to “smooth out” the long term projections by having them reflect only the underlying, non-cyclical, but predictable trends in variables such as the population, labor force, and underlying productivity growth.

The forecast horizon for this assignment is the year 2064. It is assumed that any new crossing of the Detroit River will not come online until the year 2015 at the earliest. Hence, the projection period of greatest interest here is that which encompasses the first 50 years of the operations of the new facility, from 2015 to 2064. Projecting the number of frontier crossings between now and 2064 requires an understanding of the key potential drivers of such traffic. Those potential drivers include demographic variables, such as the populations of the United States and Canada, of Michigan and Ontario, and of the Detroit and Windsor areas; and economic variables, such as the real GDP of the U.S. and Canada and of Ontario and Michigan, the volume of trade between the U.S. and Canada and between Ontario and the U.S., and the total employment of Michigan and Ontario and of the Detroit and Windsor areas, etc. Projections of these drivers need to be developed within a framework that ensures internal consistency.

No private sector economic forecasting firm provides routinely prepared and updated projections for all of these variables through to the year 2064. The Centre for Spatial Economics (C4SE) provides projections for most of these variables through to the year 2061. The Centre used its U.S.-Canada projection framework to extrapolate its base case projections for all variables to 2064.

This section of the report describes the basic assumptions behind the long-term base-case and alternative projections used in this report. In order to provide a framework for assessing the risks that surround the projections, this section also reviews the projections from a number of private and public agencies that develop long-term perspectives for either the U.S. or Canadian economies.

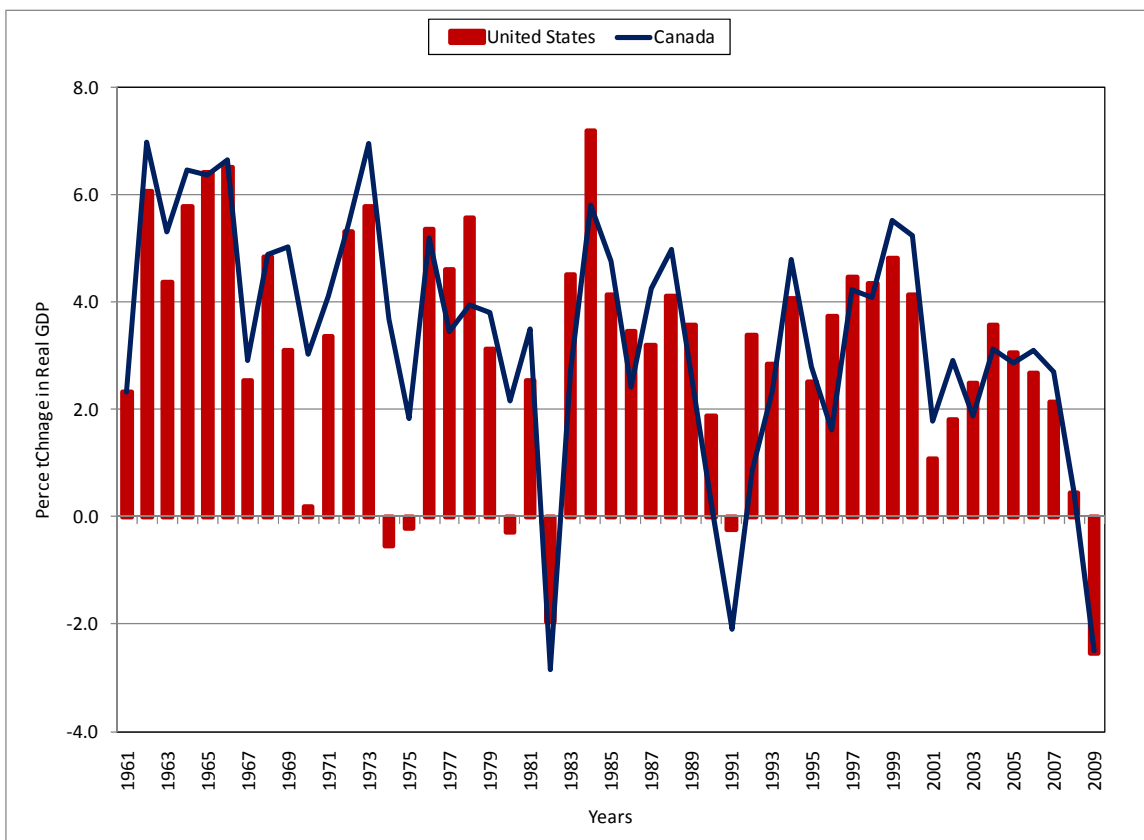
Canada and the United States have been each other’s most important trading partners for quite some time. The interdependence of the two economies grew with the Canada-United States Auto Pact of 1965, and then strengthened further during the 1990s with the enactment of the Canada-U.S. Free Trade Agreement (1989) and the North American Free Trade Agreement (1994).

In view of this growing interdependence, it comes as no surprise that the underlying rate of growth of the two economies is quite similar, and that the two economies undergo similar cyclical variations. The U.S. economy is the larger of the two (9 to 10 times

larger) and hence, U.S. trends have a greater impact on events in Canada than Canadian trends have on events in the U.S. **Exhibit 20** below compares the annual rate of growth in real GDP in Canada to that of the U.S. over the last half-century (from 1961 to 2009). Regression analysis reveals that 60 percent of the variation in Canada’s annual real rate of growth can be explained by variations in the U.S. growth rate.

Thus projecting the potential for economic growth in Canada requires a reliable projection of the potential for growth in the U.S.

Exhibit 20: Real GDP Growth for Canada and the United States, Actual Annual Percentage Change from 1961 to 2008, Estimated for 2009



Source: U.S. Department of Commerce and Statistics Canada
Data for 2009 estimated by C4SE

The Centre has been developing projections for both Canada and the U.S. since its creation in 2000, and its partnership companies were doing so individually for a number of years prior to the establishment of the Centre (Strategic Projections Inc. was established in 1989 and Stokes Economic Consulting was established in 1995). The Centre appears to be alone among the major long-term forecasters in providing projections that extend beyond a 25-year time horizon. A few look ahead 25 years, most only 10 or 15.

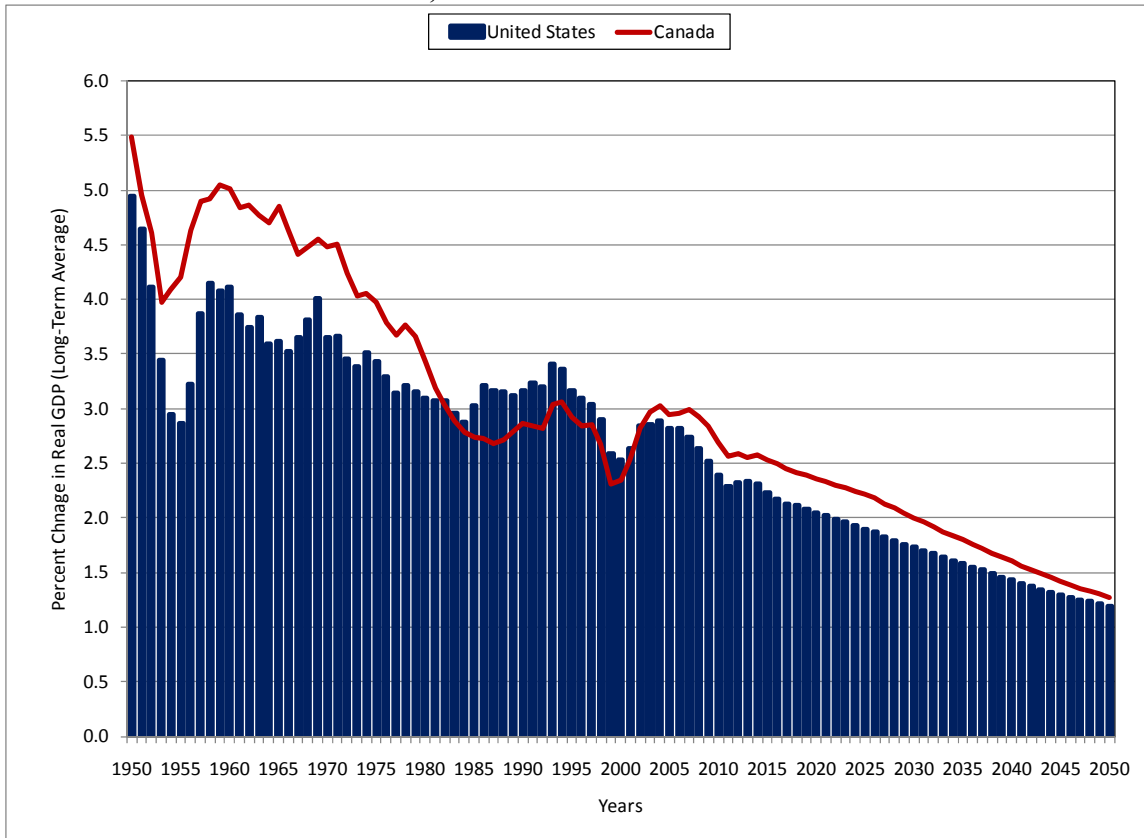
Since 2000, the Centre has drawn on information available from the U.S. Congressional Budget Office to guide its projections for potential growth in the U.S. Most CBO projections today have a time horizon of just 10 years; they call for the *potential* growth rate of the U.S. to gradually fall from 4.0 percent per year, back in 2000, and from 2.8 percent currently to 2.4 percent by 2018. Due to the current recession the actual growth rates achieved by the U.S. economy in recent years have fallen short of the estimated current potential rates of growth.

Back in 2000, the CBO created a 75-year projection to assess the long-term budgetary implications of Social Security and Medicaid. Those projections foresaw the U.S. potential real growth rate following a slowing path to 2020, mirroring its view today to that horizon, and then gradually declining further to a rate of only about 1 percent per year beyond 2050.

Expectations of a gradual decline over time in the underlying potential rate of growth for the U.S. was, and continues to be, predicated on the expectation that the U.S. population of working age (20 to 64 years) will gradually slow due to the aging of the post-WWII Baby Boomers and to the expectation that the rate of productivity growth will average somewhere between 1.0 and 1.5 percent per year over that horizon. It is worth noting that the CBO's most recent reports dealing with very long-term horizons now shy away from providing real GDP growth rate forecasts, resorting instead to making assumptions about per capita real income growth, real interest rates, and the like – all of which continue to imply a gradual slowing of underlying real GDP growth overall.

The Centre has used the CBO long-term projections for real U.S. GDP growth potential, developed back in 2000, as a guide to developing and updating its own long-term projections for the U.S. to the year 2050. **Exhibit 21** below compares the underlying real growth rates for both the U.S. and Canadian economies since 1950 (based on a 21 year centered moving average of the actual real annual rates of growth in each country) to the Centre's projected potential growth rate for each country from now through to 2050. The chart reveals that the Centre expects a gradual decline in the underlying pace of future growth in both countries, a reflection of the underlying slowing in the pace that occurred from 1951 through to now.

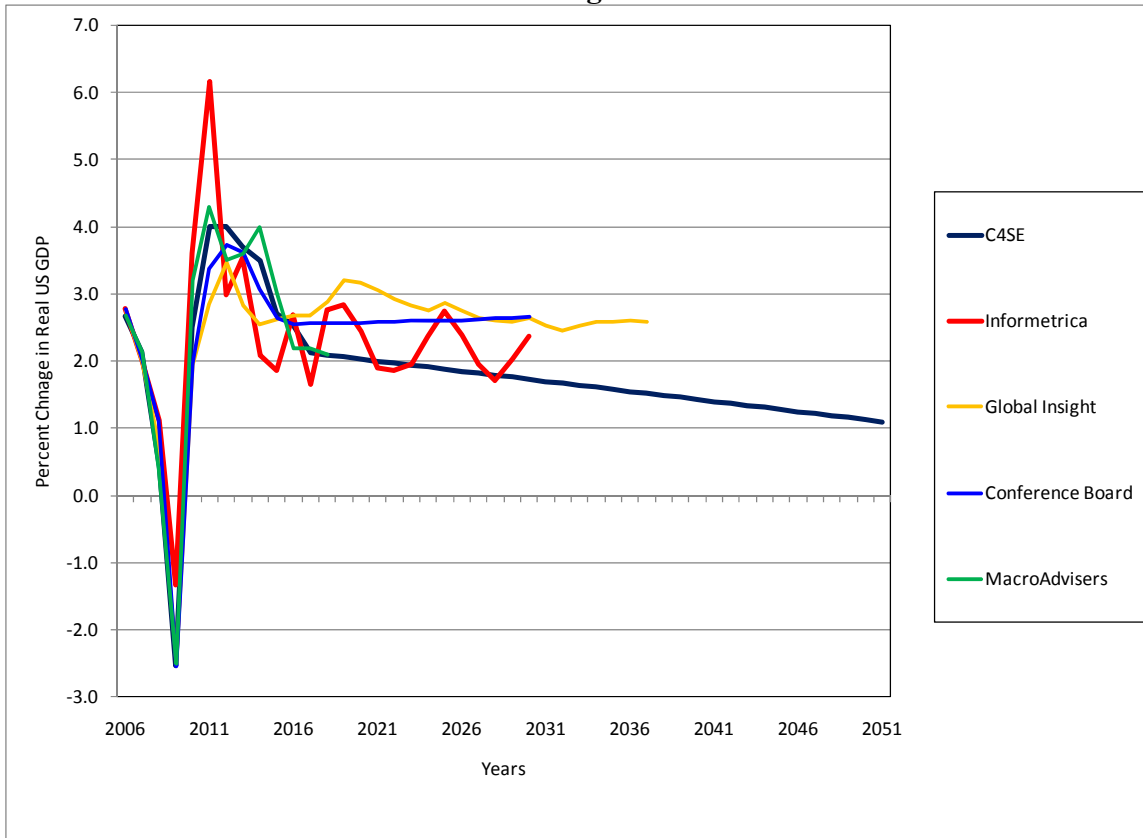
Exhibit 21: Historical and Projected Potential Real GDP Growth in the United States and Canada, Annual Percent Data from 1950 to 2050



Source: U.S. Congressional Budget Office and C4SE

For the purpose of preparing the projections in this report, Transport Canada provided the Centre with long-term projections for the U.S. they recently acquired from the Conference Board of Canada, Informetrica, and Global Insight. The Centre is an associate of Macroeconomic Advisers in the U.S. and has access to Macroeconomic Advisers' long-term view. **Exhibit 22** below compares the Centre's projected real growth rate for the U.S. to the projected rates for the U.S. as foreseen by these other four organizations.

Exhibit 22: A Comparison of Projected Real GDP Growth in the United States, Annual Percent Change from 2005 to 2051



Source: Conference Board of Canada, Informetrica, Global Insight, Macroeconomic Advisors, and C4SE

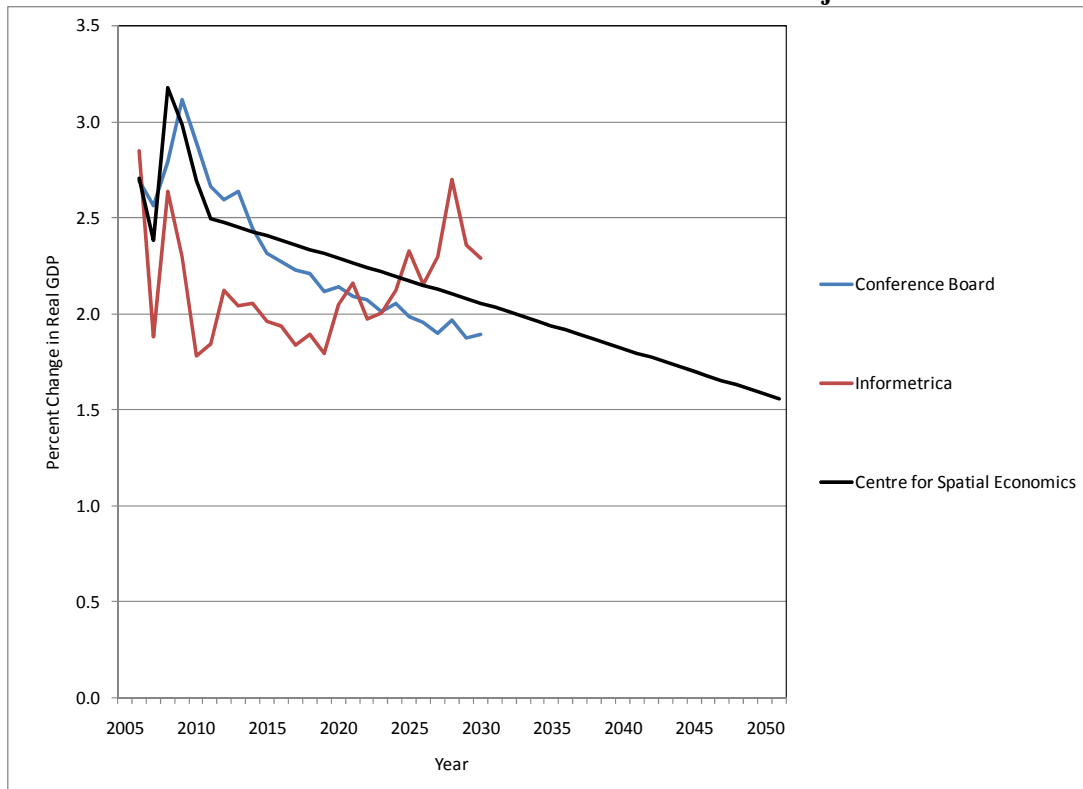
The exhibit shows clearly that all five forecasting groups expect the current recession will end this year and that significant economic growth will occur in each of 2010, 2011 and 2012. The least optimistic short-term forecast is that of Global Insight which calls for growth rates of 1.9 percent, 2.8 percent and 3.5 percent, respectively, over the next three years, totaling 8.3 percent not compounded over the 2009 to 2012 span. The most optimistic is that of Informetrica calling for gains of 3.6, 6.0 and 3.0, or 12.8 percent over the 2009 to 2012 span. Macroeconomic Advisors call for a cumulative gain of 11.0 and the Conference Board for 9.1 percent. Our projected cumulative gain of 10.5 percent, therefore, reflects a pace about in the middle of the other forecast agencies. These forecasts indicate that all major forecast groups expect the U.S. recession has already ended and that significant above potential rates will occur in the near term. Recent data indicate that the U.S. economy grew at annual rates of between 2.5 percent and 3.0 percent in each of the third and fourth quarters of 2009. In view of this strong consensus with respect to the timing and magnitude of the near-term recovery, alternative short-term scenarios have not been considered in this report.

Exhibit 21 also reveals that Macroeconomic Advisors shares the Centre’s view that following on the recovery from the recession currently underway real GDP growth will

gradually slow down. It also reveals that the other three forecasters do not foresee a slowing in the U.S. potential growth rate at all. Global Insight foresees U.S. real GDP growth averaging 2.8 percent from 2015 to 2030 and the Conference Board of Canada foresees it averaging 2.6 percent per year over the same period while Informetrica foresees it averaging 2.2. By way of comparison, C4SE foresees the U.S. rate over that period averaging just 1.9 percent, starting out at 2.5 percent in 2016 and falling to 1.7 percent by 2030 (and falling further, gradually, to 1.1 percent in the 2050s).

The package of information from Transport Canada provided for our initial report in 2008 also included long-term projections for Canada from the Conference Board of Canada and Informetrica. **Exhibit 23** below compares these forecasts for Canada at that time to that of C4SE at that time. The exhibit reveals that the Conference Board agrees with C4SE in that Canada's underlying growth rate will gradually decline between now and 2030. Indeed, the Board foresees the rate of deceleration for Canada to be greater than that foreseen by C4SE. However, the Board's view for Canada was at odds with its view for the U.S. at that time (and now) which foresees U.S. growth at a steady pace in the future.

Exhibit 23: A Comparison of Projected Real GDP Growth in Canada, Annual Percent Data from 2005 to the Final Year Projected



Source: Conference Board of Canada, Informetrica, Global Insight, Macroeconomic Advisors and C4SE

The chart above also reveals that Informetrica's view for Canada at that time was at odds with that of the Board and C4SE. Informetrica foresaw Canada growing at rates less than those foreseen by either the Board or C4SE between now and around 2020, but it foresaw Canada growing at rates well above the rates projected by the Board and C4SE beyond around 2025. The Canadian growth pattern foreseen by Informetrica – deceleration in growth followed by acceleration – was inconsistent with its view for the U.S. at that time which foresaw U.S. growth at a fairly steady pace in the future. We did not ask for updates from Transport Canada for the long-term Canadian forecasts of these organizations as their Canadian forecasts were not used in developing the projections used in our earlier report.

Those who project that U.S. growth will remain above 2.5 percent for the foreseeable future are of the view that there has been a sea change in the underlying rate of growth in output per worker (productivity) in the U.S., primarily resulting from the rapid change in technology over the last two decades. This group maintains that the U.S. will continue to grow despite an expected underlying slowdown in the pace of labor force growth (stemming from demographic factors) because future productivity growth will exceed 2.0 percent per year or more, up from the long-term average rate of 1.0 percent. Those who continue to expect that the underlying rate of growth in the U.S. will decelerate over time also believe future productivity growth will be higher than in the past. But this group believes the improvement in long-term productivity growth will be to only around 1.5 percent per year, not to 2.0 percent.

The above comparison of long-term projections for the U.S. and Canada suggests that, while the Centre's view of the future may be less ambitious than that of some other forecasters, it nevertheless shares their view that real GDP on both sides of the border will continue to grow across the entire projection horizon. The Centre's view can be distinguished from the others in two significant ways:

The Centre foresees continuing strong ties between the two economies but that the underlying growth rates of both economies will gradually decline together over time.

The Centre's relatively conservative view of the long-term growth potential for both countries means its projections for real GDP (and other variables) set the minimum levels that can likely be expected across the projection horizon.

The Centre's U.S. and Canadian projections were used in this report as the basis for projecting future overnight passenger vehicle and commercial vehicle traffic crossings across the frontier. In view of the statement above, the projections for such crossings contained in this report can be viewed as the minimum volumes of traffic that can be anticipated across that frontier in the decades ahead.

The projection horizon of this report extends beyond a half century. As a result, it is fraught with greater uncertainty than the typical 25 or 30 year span considered in most planning circles.

When looking ahead, it is standard practice to consider what could go wrong, with the implication being that the risks in the future are all on the downside. Yet many things

went wrong over the last half century and the industrialized world, nevertheless, continued to flourish, bringing much of the rest of the world along in its wake.

Clearly, it is impossible to anticipate major disasters such as world-wide wars and plagues. Considerable comfort can be taken from the fact that, over the last half century, conflicts and epidemics have been regional, not world-wide, and that both the U.S. and Canada have largely been spared – at least geographically – from both. Although the future remains unpredictable, there is no reason, at this point in time, to expect the next 50 years to be any different in this regard from the last 50 years in the U.S. and Canada.

The emergence of China and India as economic powerhouses may affect the economic dominance of the industrialized world's participants in the decades ahead, especially the U.S. Yet over the last half century, the industrial world adjusted to – indeed benefited significantly from – the reemergence of Germany and Japan, and the emergence of many newly industrialized nations, all with only a few interruptions in the underlying pace of the world's economic activity.

The growing demand for energy world-wide, in the face of shrinking energy supplies, is seen by some as a huge, lingering threat to continued growth in the industrialized world. Yet the industrialized world's consumption of oil and gasoline per dollar of real GDP today is much lower than it was in the 1970s. And today's elevated oil and gasoline prices are spawning not only new sources of oil supply but, more importantly, new sources of alternative energy.

So while the above list may raise questions about the ability of the U.S. and Canada to continue to grow in the future, it is useful to note there are many reasons to expect growth to flourish.

The emergence of China and India reflects a gradual trend world-wide toward the adoption of relatively more market-based economies and relatively more democratic political structures. The more the world moves in that direction, the more competition there will be for the established industrial nations. Historically, the industrialized world has responded to new competition by shedding industries in which they can no longer compete and by shifting resources into areas in which they can. They have shifted resources especially into new products and services that did not exist before, that their creative people designed, and that their citizens can now afford, as their productivity and standards of living increased.

The U.S. and Canada attract migrants from every corner of the planet with their high standards of living, job opportunities, and lifestyles. Achieving the populations projected for both countries in this report requires that both continue to accept major net inflows of immigrants each year across the projection horizon. Both countries could potentially influence the growth of their respective populations through the immigration policies both economies chooses to implement and enact.

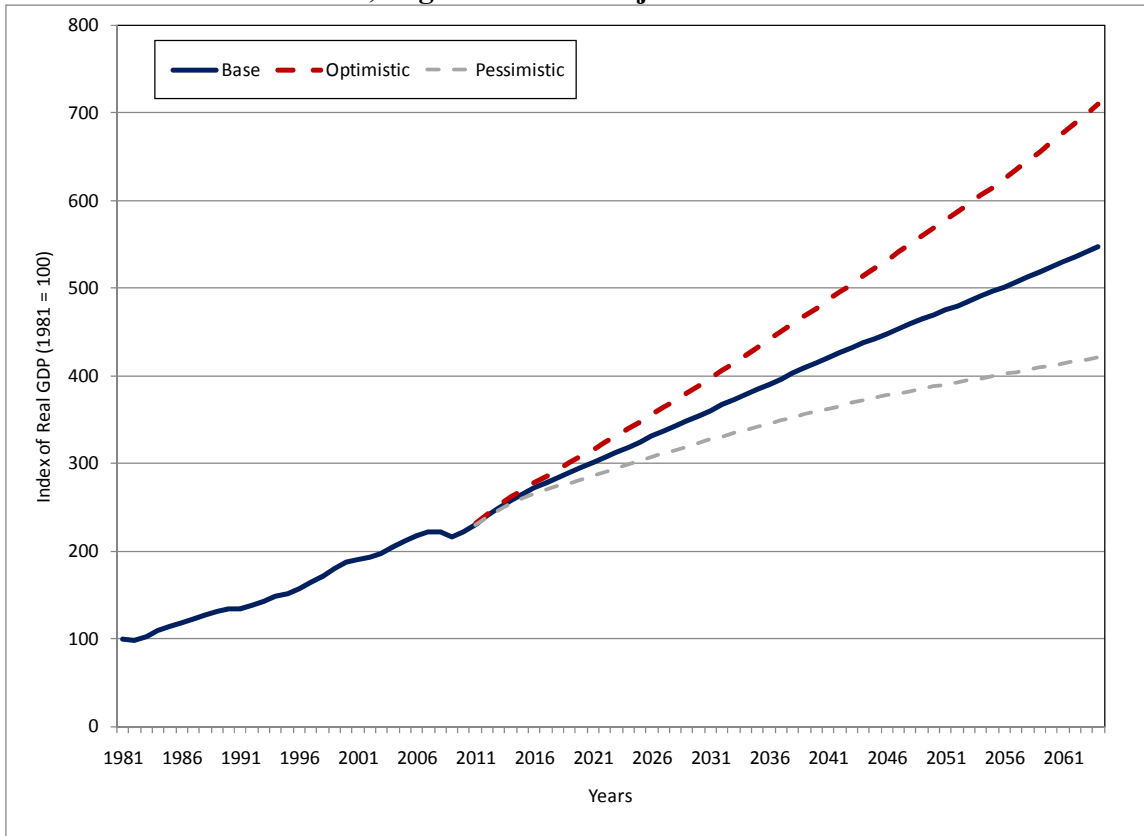
As noted above, many economists feel that future productivity growth will be significantly higher in the future throughout the industrialized world. If they are right, the potential growth rates for both the U.S. and Canada are much higher than those envisaged in the baseline case and alternative projections applied here.

All things considered, the baseline case and alternative projections for the U.S. and Canada contained in this report reflect an achievable potential expansion path for the two countries in the decades ahead.

Baseline case projections in this report are (partially) based on C4SE's projected future profile for U.S. real GDP growth. The Centre also developed a high (or optimistic) projection that assumes that U.S. real GDP will grow at a rate 0.5 percent per year faster than assumed in the baseline case, and a low (or pessimistic) alternative that assumes a rate 0.5 percent per year less than the baseline case. In both the high and low cases, it was assumed that the pace would stray from the baseline rates in gradual increments over the five year period from 2008 to 2013, reflecting the recession currently underway and the recovery expected by all major forecasters in 2010 through 2013. Again, it is standard procedure among long-term forecasters to develop alternative projections using a similar methodology. The range itself cannot be tested against history, since historical growth occurred at now observable rates. We are certain about those past rates; we do not observe any upper and lower bounds to what has actually occurred. The baseline case trend rate that we project is based on what we consider to be reasonable expectations about future population growth, future population growth among those of working age, and future growth in output per worker. We are fairly certain about the population projections, but we are less certain about the productivity projections. Based on historical observation, we are reasonably sure that if productivity growth in the future is to exceed, or fall short, of the baseline case rate of 1.0 to 1.5 percent that we foresee, it is unlikely to vary from the baseline case view on a sustained basis by more than 0.5 percent per year on either side.

Exhibit 24 below illustrates the impact that these assumptions have on the level of projected real U.S. GDP by the year 2064. The index for real U.S. GDP is estimated at 222 in 2008. In the base case it reaches 547 in 2064, implying that by that year the U.S. economy is 2.5 times its size in 2008. The index in 2064 in the high case reaches 710, implying an economy 3.2 times its size today. The index in 2064 in the low case is 422, implying an economy that is 1.9 times its size today. In other words, based on our assumptions, we expect the U.S. economy in 2064 to be at least 1.9 times its size today, but no more than 3.2 times its size today, with our best guess showing that it will be 2.5 times its size today.

Exhibit 24: Index of Real GDP in the United States (1981=100) for the Baseline, High and Low Projection Alternatives



Source: C4SE

It is useful to note that the optimistic forecasts used as part of this study fall below the outlook expressed by several sources that believe the long-term potential growth rate for the U.S. real GDP is not on a declining trend, and expect it to remain at a steady future growth rate of approximately 2.7 percent per year. Under their assumptions, the U.S. real GDP by 2064 would equal 4.4 times its current size in 2008, which appears to be an aggressive outlook and the Centre is not convinced that this latter view reflects the most likely future path of real growth for the U.S. The Centre feels that its baseline case best represents the most likely future path of U.S. growth. But C4SE also feels that the probability that the future path will be greater than that of the baseline, will exceed the probability that the future path will fall short of the baseline. The Centre attaches a cumulative 60 percent probability to its baseline case, a 30 percent probability to its high case and a 10 percent probability to its low case. There is no scientific way of assigning these probabilities. The range of probability assignment is made purely on the basis of professional judgment.

The Centre is also convinced that Canada's potential for growth is inextricably tied to that of the U.S. As a result, the Centre feels that, while Canada's potential growth rate

will slightly exceed that of the U.S. in the future, reflecting its tendency to do so in the past, it is also convinced that Canada's underlying growth rate will gradually slow in line with that of the U.S. over the projection horizon.

All of the projections in this report that are tied to economic or demographic variables reflecting these projected underlying trends. Therefore, the probabilities attached to the high, baseline, and low projections for each of the alternatives described above can, in turn, be applied to the high, baseline and low projections for each of the individual variables.

4.4.3 Passenger Vehicle (Overnight) Growth Scenario Alternatives

The main driver of overnight passenger vehicle crossings was found to be the sum of the total populations of Ontario and Michigan. The Centre for Spatial Economics used its U.S. and Canadian long-term economic and demographic projection platforms to determine the impact on the populations of these two areas if the U.S. economy grows 0.5 percent per year faster and 0.5 percent per year slower than the base case projection for the U.S. economy, as was done in developing alternative projections for the other (i.e., commercial vehicle) types of traffic crossings.

The C4SE system projects the national trends in output by major industry group for both countries and then allocates that future growth within each country, based on the relative industrial strengths on a state-by-state and province-by-province basis in the base year. This allocation results in significantly faster future growth in some states and provinces and significantly slower future growth in others. The level of projected real GDP for each state and province then determines the total number of jobs that can be expected in each, for the decades ahead. The system also develops detailed age and gender projections of the population for each state and province. Net migration across states and provinces and across international frontiers for both countries are developed as the system clears the labor market on a state-by-state and province-by-province basis through a match-up between the number of jobs created in each and the number of people aged 20 to 64 years in each. Migrants flow into states and provinces where job growth is projected to exceed the growth in population 20 to 64 and out of states and provinces where the reverse holds true.

An incremental increase in the expected real growth rate of the U.S. economy, by 0.5 percent per year, results in larger population projections for both the U.S. and Canada in total over time, and in a larger population in each of Michigan and Ontario over time. An incremental decrease in the expected real growth rate of the U.S. economy, by 0.5 percent per year, results in declines in the population projections of both through the decades.

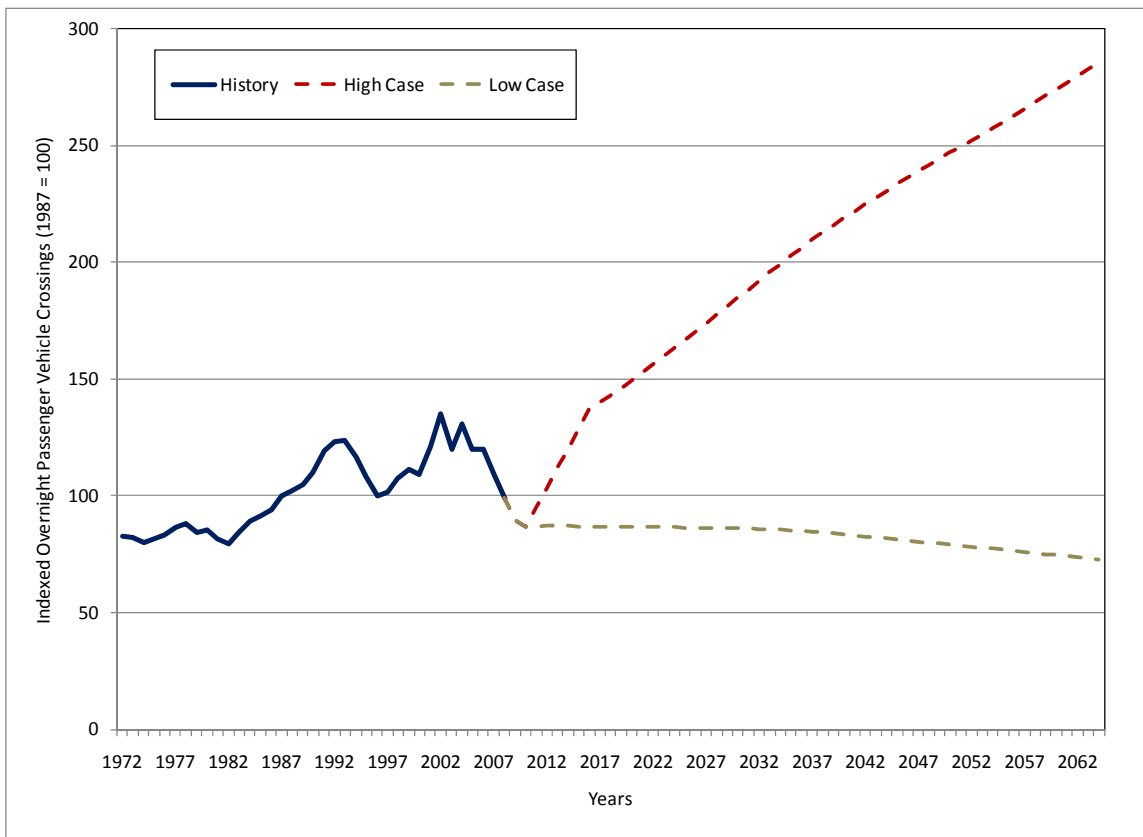
In generating the low case alternative projection for overnight passenger vehicles, we used the lower population projections stemming from a slower U.S. real economic growth rate overlaid with the assumption that the overnight passenger base has been permanently reduced by about 30 percent by the passport and other security measures put in place in the post-911 environment (as was assumed in the base case). In generating the high case alternative projection for overnight passenger vehicle crossings, we used the

higher population projections stemming from faster U.S. economic growth, and between 2010 and 2016 gradually relaxed the 30 percent reduction from the base case.

The impacts of the high and low alternatives on future growth in overnight passenger traffic across the frontier are illustrated in **Exhibit 25**.

Exhibit 25: Indexed Forecast Corridor Growth for the Alternative Scenarios: Overnight Passenger Vehicle Crossings (1987=100), Selected Years

Border Crossing Type	Scenario	Years						
		2008	2018	2028	2038	2048	2058	2064
Overnight Passenger	Low Case	99	86	86	84	80	76	73
Overnight Passenger	High Case	99	143	177	213	242	268	286



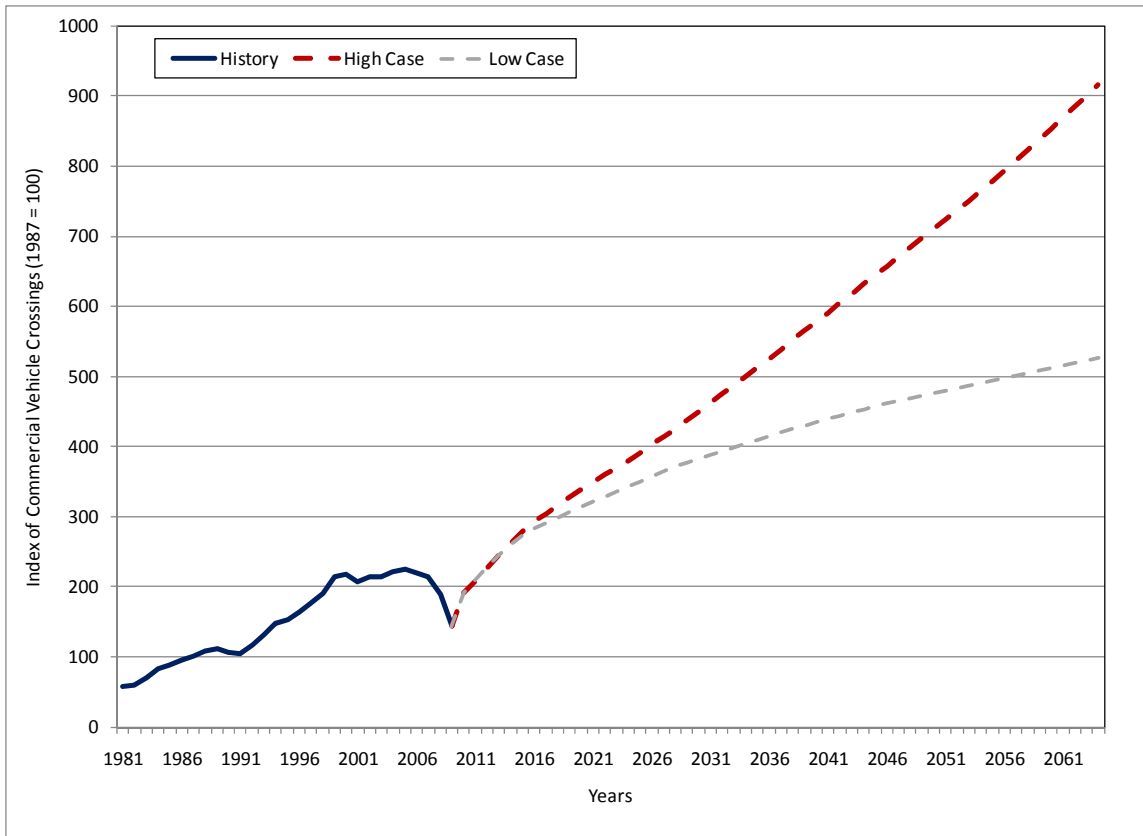
In the high case scenario, the index value (1987=100) of overnight passenger vehicles is projected to increase by 2.9 times, from 99 in 2008 to 286 in 2064, or at an average annual compound rate of 1.91 percent.

In the low case scenario, the (1987=100) index of overnight passenger vehicles is projected to be lower than its current level, from 99 in 2008 to 73 in 2064, declining at an average annual compound rate of 0.55 percent.

4.4.4 Commercial Vehicle Growth Scenario Alternatives

Exhibit 26: Indexed Forecast Corridor Growth for the Alternative Scenarios: Commercial Vehicle Crossings (1987=100), Selected Years

Border Crossing Type	Scenario	Years						
		2008	2018	2028	2038	2048	2058	2064
Commercial Vehicles	Low Case	190	299	371	425	469	504	526
Commercial Vehicles	High Case	190	316	427	552	684	823	917



As shown in **Exhibit 26**, the index value (1987 = 100) of commercial vehicle crossings in the high case scenario is projected to increase by 4.8 times, from 190 in 2008 to 917 in 2064, or at an average annual compound rate of 2.86 percent.

In the low case scenario, the index value (1987=100) of commercial vehicle crossings is projected to increase to 2.8 times its current level, from 190 in 2008 to 526 in 2064, or at an average annual compound rate of 1.84 percent.

5. Conclusions

Growth in the vehicle crossing volumes along the Detroit-Windsor-Port Huron-Sarnia frontier has varied over time, and by crossing type. The sections above demonstrate that

the growth in border crossing demand through the frontier is dependant on macroeconomic variables and the changes in those variables, including economic output (GDP), foreign trade turnover, exchange rate, population, and employment, with those exhibiting the most significant correlation with crossings growth. Vacillations in the crossings growth patterns have reflected the different periods of strength and weakness in the regional and national economies, and have also been strongly influenced by institutional and psychological barriers stemming from the impacts caused by the extraordinary events of 9/11.

In this analysis, the econometric approach adopted for the derivation of the crossings demand is based on the projections of the changes in the independent socioeconomic variables identified as strong drivers of the crossings growth. Consequently, the long-term forecasts of the crossings growth are influenced by the projections of the different independent variables.

Based on this approach, the overall crossings demand along the frontier is projected to appreciate, for the baseline projection scenario, about 2.7 times (or 1.80 percent, per annum) for same-day crossings, 1.2 times (or 0.34 percent annually) for overnight passenger crossings, and 3.7 times (or 2.35 percent per year) for the commercial truck traffic over the 2008-2064 time horizon.

In light of the very long horizon, it should also be kept in mind that these forecasts serve as guidelines, since the future cannot be predicted with absolute certainty, and the forecast is subject to various unpredictable circumstances and events. Therefore, any related planning of the crossing corridor improvements must remain sufficiently flexible to adequately respond to unforeseen shocks. In addition to the baseline forecasts, to better envision a range of potential corridor demand outcomes, an envelope of projections was developed based on the low and high scenarios.

Corridor Growth
Appendix CG-A: Data Sources

Note that socioeconomic forecasts utilized to estimate corridor growth rates are not available throughout the entire future time horizon. Resultantly, to overcome this data gap, the available and applied forecasts, for the years provided, were extrapolated to encompass the years through 2064.

Exhibit 27: Data Sources for the Applied Variables

	Variable	Historical/Projected	Scenario(s)	Sources	
Same-Day Crossings	Border Crossings	Historical	All	Statistics Canada and WSA Team estimates	
	SEMCOG population	Historical	All	Bureau of Economic Analysis and U.S. Census Bureau, U.S. Dept. of Commerce	
	Windsor-Sarnia Economic Region employment	Historical	All	Statistics Canada	
	Michigan employment	Historical	All	Bureau of Economic Analysis, U.S. Dept. of Commerce	
	Ontario employment	Historical	All	Statistics Canada and Ontario Ministry of Finance	
	9/11 (Dummy)	Historical	All	WSA Team	
Same-Day Crossings	SEMCOG population	Projected	All	SEMCOG and WSA	
	Windsor-Sarnia Economic Region employment	Projected	All	C4SE and WSA	
	Michigan employment	Projected	All	University of Michigan's REMI adjustment and RSQE, and WSA	
	Ontario employment	Projected	All	Ontario Ministry of Finance 2009 Ontario Economic Outlook and Fiscal Review, C4SE and WSA	
	9/11 (Dummy)	Projected	All	Impact of 9/11 are assumed to taper off over a 20 yr period beginning in 2016, becoming non-influential by 2034 (generational memory)	
	Overnight Crossings	Border Crossings	Historical	All	Statistics Canada and WSA Team estimates
Michigan population		Historical	All	US Census Bureau	
Ontario population		Historical	All	Statistics Canada	
Michigan population		Projected	Baseline	C4SE	
Ontario population		Projected	Baseline	C4SE	
Michigan population		Projected	Low	C4SE	
Overnight Crossings	Ontario population	Projected	Low	C4SE	
	Michigan population	Projected	High	C4SE	
	Ontario population	Projected	High	C4SE	
	Commercial Vehicle Crossings	Border Crossings	Historical	All	Statistics Canada and WSA Team estimates
		Ontario Trade Turnover	Historical	All	Statistics Canada - Provincial Economic Accounts
		U.S. Real GDP	Historical	All	U.S. Department of Commerce
Canada-US Exchange Rate		Historical	All	Bank of Canada	
Ontario Trade Turnover		Projected	Baseline	C4SE	
U.S. Real GDP		Projected	Baseline	C4SE	
Commercial Vehicle Crossings	Canada-US Exchange Rate	Projected	Baseline	C4SE	
	Ontario Trade Turnover	Projected	Low	C4SE	
	U.S. Real GDP	Projected	Low	C4SE	
	Canada-US Exchange Rate	Projected	Low	C4SE	
	Ontario Trade Turnover	Projected	High	C4SE	
	U.S. Real GDP	Projected	High	C4SE	
Commercial Vehicle Crossings	Canada-US Exchange Rate	Projected	High	C4SE	

THIS PAGE INTENTIONALLY LEFT BLANK

APPENDIX **D**

MODEL VALIDATION REPORT

This appendix contains the documentation of the travel demand model 2008 update as provided by the subconsultant, IBI Group for the Transport Canada 2008 comprehensive study.

THIS PAGE INTENTIONALLY LEFT BLANK



Transport
Canada

Transports
Canada

Transport Canada

**TRAFFIC AND REVENUE FORECASTER: WINDSOR
GATEWAY PROJECT
UPDATE OF TRAVEL DEMAND MODEL REPORT**

DRAFT

JANUARY 2009



TABLE OF CONTENTS

1.	INTRODUCTION	1
1.1	Background	1
1.2	Model Process & Methodology	1
2.	ROAD NETWORK.....	5
2.1	Road Network	5
2.2	Zone System.....	10
3.	TRAVEL DEMAND.....	11
3.1	Analysis Time Periods	11
3.2	Domestic Demand	11
	3.2.1 Domestic Future Vehicles Demand.....	12
3.3	International Vehicles	12
	3.3.1 International 2008 Passenger Vehicle Demand.....	12
	3.3.2 International 2008 Commercial Vehicle Demand.....	13
	3.3.3 Comparison of International Vehicle Demand with Previous Studies	14
	3.3.4 International Future Passenger Car and Commercial Vehicles Demand	16
4.	VALIDATION.....	17
4.1	Screenlines	17
4.2	Travel Times validation.....	22

TABLE OF CONTENTS (CONT'D)

LIST OF EXHIBITS

Exhibit 1-1 Model Process	3
Exhibit 2-1 Modelled Area	5
Exhibit 2-2 Road Network Updates 2004-2008.....	6
Exhibit 2-3 Crossing Speeds and Capacities.....	6
Exhibit 2-4 Network Speeds & Capacities	7
Exhibit 2-5 New Crossing Layout - Alternative-X10B	8
Exhibit 2-6 2015 & 2025 Network Updates.....	9
Exhibit 3-1 Peak Hour Factors for Domestic Matrices	12
Exhibit 3-2 Spring 2008 Peak Period Volumes for Passenger cars.....	13
Exhibit 3-3 Spring 2008 Peak Period Volumes for Commercial Vehicles.....	14
Exhibit 3-4 Peak Period Volumes at Detroit-River Crossings, PCE's, Summer 2000 & Spring 2008.....	15
Exhibit 3-5 Growth Indexes for International Traffic.....	16
Exhibit 4-1 Detroit-Windsor Cordons	18
Exhibit 4-2 Total Volume Comparison Between City of Windsor and Field Traffic Counts	19
Exhibit 4-3 2008 Cordon Validation	19
Exhibit 4-4 2008 Observed and Model-Predicted Link Volumes	21
Exhibit 4-5 Travel Time and Speeds Validation - Windsor	23
Exhibit 4-6 Travel Time Segments for Detroit.....	24
Exhibit 4-7 Travel Time and Speeds Validation - Detroit.....	24

1. INTRODUCTION

1.1 Background

The *Traffic and Revenue Forecaster for the Windsor Gateway Study* requires updated forecasts to reflect recent trends and travel patterns, network conditions, and projects relating to the Detroit Windsor Gateway. The forecasts are founded on an updated version of the travel demand model initially developed for the *Detroit-River International Crossing Study (DRIC)* in 2005. The updated model is designed to account for and provide the following:

- Changes in international travel demand and travel patterns;
- Recent information on transportation and economic growth;
- Traffic and revenue forecasts for the new crossing;
- Estimate traffic impacts of the new crossing.

The major tasks of the study include development of an updated travel demand model with a base year set in 2008. The update of the travel demand model includes the following tasks:

1. Refresh of trip tables for the base year and future years. Trips tables contain the travel patterns for passenger-cars and commercial vehicles during the a.m. and p.m. peak hours, as well as mid-day and evening non-peak periods. The passenger-cars trip tables update was based on a recent origin-destination survey conducted during April 2008 at the Ambassador Bridge, the Detroit-Windsor Tunnel and the Blue Water Bridge. These survey data represent the most recent travel patterns observed in the Detroit-Windsor border crossings. The survey data was validated against newly collected traffic data. As for commercial vehicles, the latest trip table data are based upon the 2006 National Road Survey (NRS) provided by Transport Canada. Future year trips tables were developed using fresh forecasts for passenger-cars and commercial vehicles.
2. Update of road networks. Road networks were updated to account for the changes that have taken place in the transportation infrastructure in Detroit and Windsor since the last update of the travel demand model. The future year road networks were updated with recent versions of existing transportation plans.
3. Traffic Assignment and Validation. The travel demand model main outputs, i.e., traffic volumes and travel times, were validated using an extensive collection of traffic counts collected during the spring 2008 as well as other sources of traffic count data, and travel times data.

1.2 Model Process & Methodology

The DRIC model had the purpose of identifying existing and future transportation problems related to the crossings capacity in the region. The study also analysed a set of new crossing alternatives to address the transportation deficiencies and develop a transportation strategy. The travel demand model focused on adequate modelling periods, trip matrices updated to a 2004 base year, network

update and enhancement, and the incorporation of the new crossing alternatives and crossing choice models. For passenger travel, the model explicitly captures the following markets:

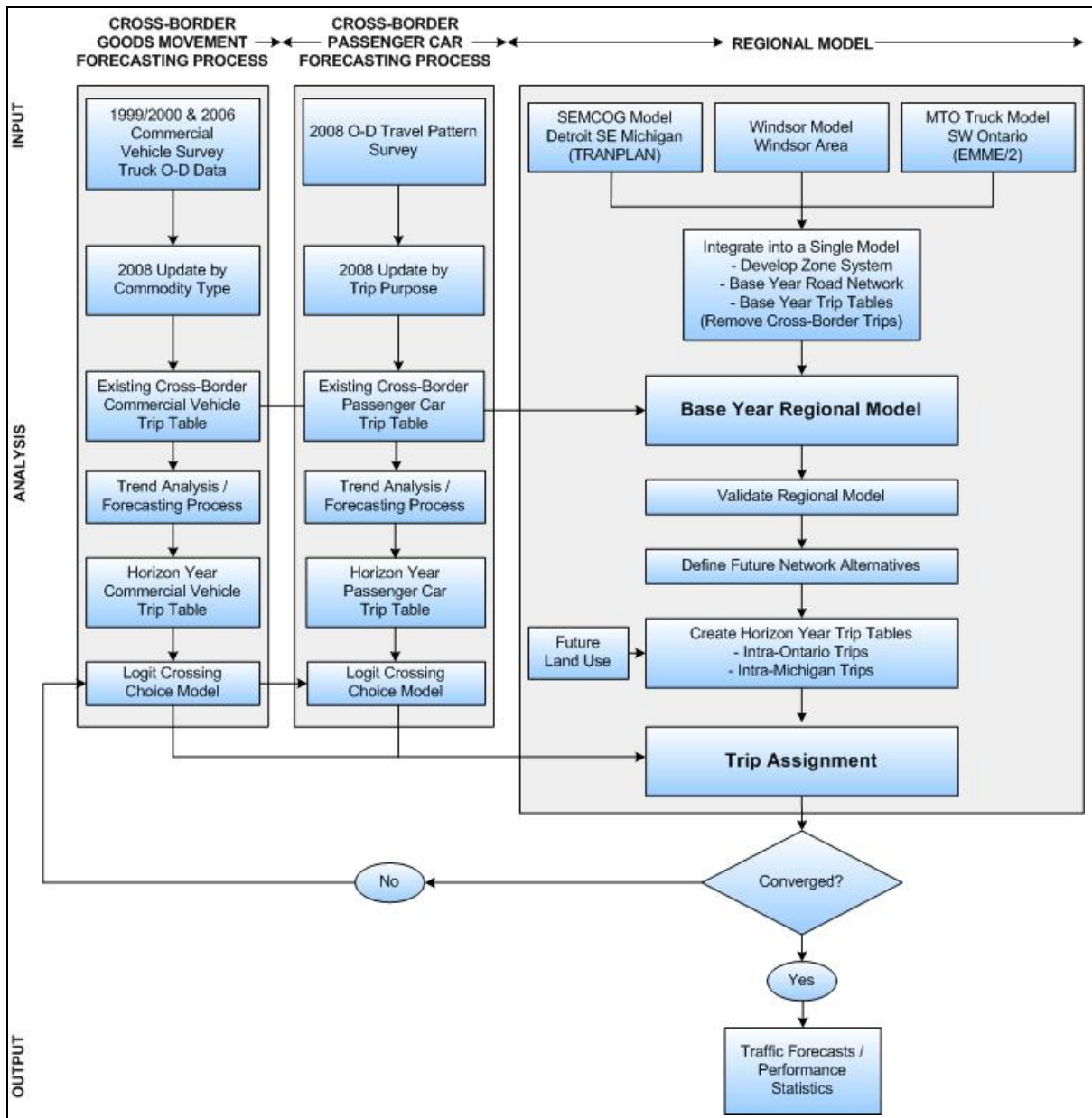
- Same-day work / business;
- Same-day other trip purposes;
- Overnight trips;

For goods movement, the model captures the following commodity groups:

- Automotive/metal industry products including autos and auto parts;
- Forest products such as processed or unprocessed timber, paper;
- Machinery and electronics not part of the auto industry;
- Animal and plant including livestock and processed and unprocessed food and grain;
- Other (including chemical and petroleum products, rubber and plastics, textiles, minerals, and stone/ceramic/glass);

The model process is given in the following Exhibit.

Exhibit 1-1 Model Process



The model update methodology is as follows:

- Update road network, including all transportation improvements that are assumed to be built over the study horizon;
- Update international passenger demand, based on the origin destination (OD) data collected and expanded in the Data Collection portion of the study;
- Update domestic demand (passenger and commercial vehicle), based on prior travel patterns and recent trends in travel and economic growth;

- Update international commercial goods demand, based on the OD data and expansion;
- Assign demands to the road network and calibrate to newly collected traffic counts;

The calibration involves evaluating the expansion factors for the international OD demand data collected in the travel survey, and estimating the travel times and waiting times at each border facility that result in the observed crossing data.

2. ROAD NETWORK

2.1 Road Network

The study area, illustrated in Exhibit 2-1, includes a vast area of southeast Michigan and southwest Ontario, including the Detroit-River crossings and the Blue Water Bridge.

Exhibit 2-1 Modelled Area



The model road network is derived from the DRIC study, and is composed of the following geographic areas:

- Windsor Area: high level of detail of urban area, including local collectors, arterials, freeways and highways in Windsor, Tecumseh and LaSalle.
- Rest of Essex: moderate level of detail of sub-urban area including county roads and highways.
- Southwestern Ontario: outside of Essex county includes major highways.
- Rest of Canada and Ontario: east of London includes major highways to connect external area zones.

- Detroit Area: high level of detail of urban area, including almost all roads, avenues, freeways and highways.
- Rest of Southeastern Michigan: uses the SEMCOG network for this area.
- Rest of Michigan and US: basic level of highways coverage to connect the external zones.

For this study, the road improvements listed in Exhibit 2-2 were incorporated into the road network to account for the change in base year from 2004 to 2008. Most of the road improvements are arterial roads that were widened over recent years in Windsor; none of them were made on roads connecting directly to the crossings. No major road improvements were identified on the US side since the DRIC study.

Exhibit 2-2 Road Network Updates 2004-2008

Street Name	Description of Improvement
Dougall Ave.	Segment between Chatham St. and Pitt St. was removed from network
Walker Rd.	Widened to 4 lanes between Legacy Park Dr. to Highway 3
Lauzon Rd.	Widened to 4 lanes between Wyandotte St. and Tranby Ave.
Provincial Rd./Division Rd.	Widened to 4 lanes from Howard Ave. to City Limits
Cabana Rd.	Widened to 4 lanes from the CN tracks near the airport to Huron Church Rd.
Howard Ave.	Widened to 4 lanes from Hwy. 3 to Division Rd.

The network link attributes are summarised in the Exhibit 2-3 and Exhibit 2-4, and are based on the link classifications developed for the DRIC study. Three new attributes were added to the network to consider the road capacity for the peak/off-peak and mid-day periods, which consisted of multiplying the road capacity by the number of hours of each period.

Exhibit 2-3 Crossing Speeds and Capacities

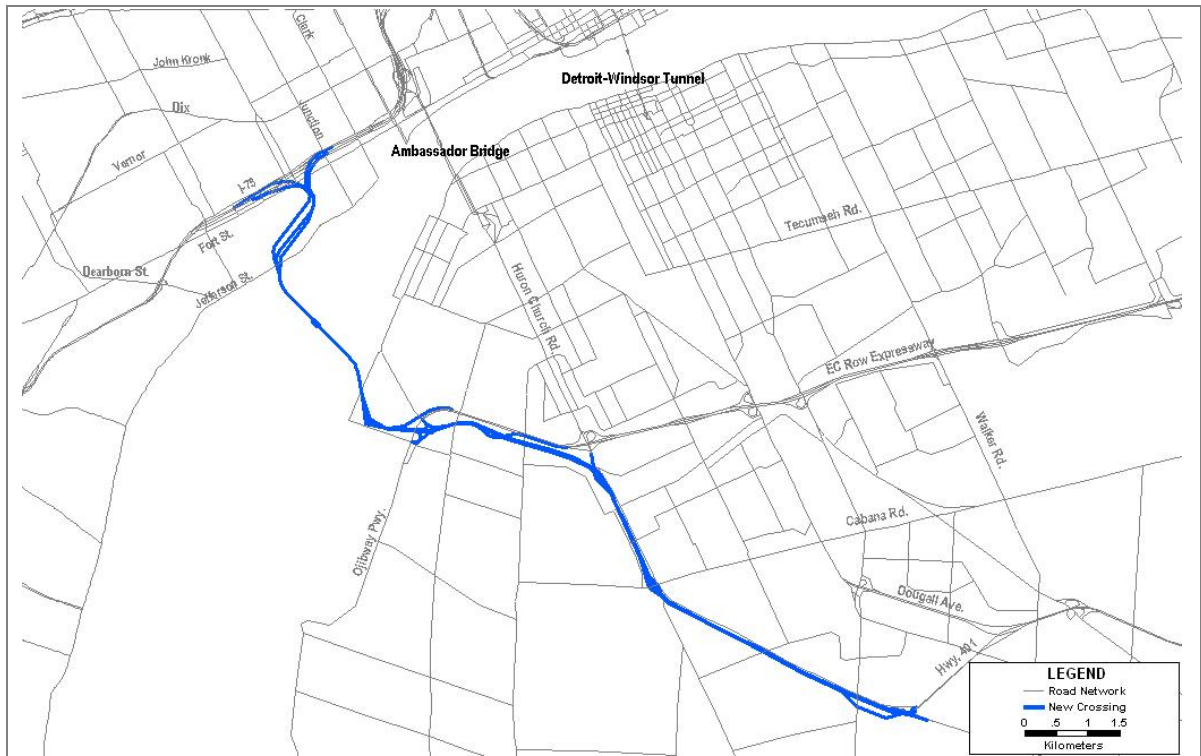
Facility	No of Lanes One-Way	Capacity Per Lane (PCEs/h)	Total One-Way (PCEs/h)	Speed (km/h)
Ambassador Bridge	2	1,750	3,500	60
Blue Water Bridge	3	1,900	5,700	90
Detroit-Windsor Tunnel	1	1,500	1,500	40

Exhibit 2-4 Network Speeds & Capacities

Functional Class	Capacity Per Lane (PCEs/h)	A.M. Capacity Per Lane (PCEs/h)	Mid-day Capacity Per Lane (PCEs/h)	P.M. Capacity Per Lane (PCEs/h)	Speed (km/h)
Rural Freeway	2,200	6,600	13,200	8,800	100
Urban freeway	2,000	6,000	12,000	8,000	90
Rural Arterial	1,100-1,250	3,300-3750	6,600-7,500	4,400-5,000	50-80
Urban Major arterial	900	,2700	5,400	3,600	50-70
Minor arterial	800	2,400	4,800	3,200	35-80
Collector	650	1,950	3,900	2,600	35-60
Local street	500	1,500	3,000	2,000	30-50
Freeway ramp	1,300	3,900	7,800	5,200	50-100
Local non-through	350	1,050	2,100	1,400	35-50
Centroid connector	n/a	6,600	13,200	8,800	50-80

The new crossing alternative and access roads were coded in the future year networks from the DRIC study, as illustrated in Exhibit 2-5. The new crossing coding was reviewed to ensure the proper network connectivity to connecting roads for the future year networks 2015, 2025 and 2035. Particular emphasis was put in the main connections of the new crossing with the Highway 401, Highway 3, Huron Church Rd., Cabana Rd., EC Expressway and Ojibway Parkway in Canada and interstate I-75 in the US. Few minor adjustments were introduced into the network to match against the preferred crossing alternative.

Exhibit 2-5 New Crossing Layout - Alternative-X10B



A list of committed road and highway projects is presented in Exhibit 2-6. The list displays the most relevant future road improvements and is the result of a thorough review of relevant transportation plans by the Ontario Ministry of Transportation, SEMCOG and the City of Windsor.

Exhibit 2-6 2015 & 2025 Network Updates

City	Street Name	Description of Improvement
Windsor (2015)	McHugh St.	Extended from Lauzon Rd./Lauzon Pwy. to Florence and widened to 4 lanes
	Wyandotte St.	Extended from Riverdale Ave. to Jarvis Ave. /Banwell Rd. (no widening)
	Provincial Rd./Division Rd.	Widened to 4 lanes from Howard Ave. to City Limits
	Cabana Rd.	Widened to 4 lanes from the CN tracks near the airport to Huron Church Rd.
	Howard Ave.	Widened to 4 lanes from Hwy. 3 to Division Rd.
	EC Row Pwy.	Widened to from 4 lanes to 6 lanes from Huron Church Rd. to Manning Rd.
	Tecumseh Rd.	Widening from 4 to 6 lanes between Jefferson Blvd. and Lesperance Rd.
	Huron Church Line	Widening from 2 to 4 lanes between Hwy. 3 and Sandwich W Parkway
	Highway 401	Widening from 4 to 6 lanes in the Windsor area from 0.5 km east of Highway 3 to 1.0 km east of County Road 42
	Highway 402	Major reconstruction of a 20 km stretch of the highway approaching Sarnia area. This project will not increase capacity but an improved roadway to accommodate heavier vehicles and reduce pavement maintenance.
Detroit (2015)	Ambassador Bridge Gateway	Reconstructed freeways and a new interchange for interstates I-75 and I-96, a pedestrian bridge connecting east and west Mexicantown and a redesigned Ambassador Bridge Plaza
	I-375 Interchange	Improvements to the interchange between interstate I-375 and Jefferson Ave, improving access to the interstate highway system for Detroit-Windsor Tunnel users
	I-94 Widening	Rehabilitation and widening of a 7 mile segment of interstate I-94 from 3 to 4 lanes road section.
	Jefferson Ave.	Roadway improvements from US-10 to interstate I-375 also facilitating access to the Detroit-Windsor Tunnel
Windsor (2025)	Division Rd.	Widening from 2 to 4 lanes from Walker Rd. to E Puce Rd.
	Highway 22	Widening from 2 to 4 lanes between Manning Rd. and Charron Beach Rd.
	Manning Rd.	Widening from 2 to 4 lanes between Talbot Trail and Hwy. 22

2.2 Zone System

The zone system was carried forward from the DRIC study without changes. The system is disaggregated into 1,510 zones as follows:

In Canada:

- 464 zones representing the municipalities closest to the Detroit River Crossings: the City of Windsor, the Towns of Tecumseh and LaSalle, and the former municipality of Maidstone;
- 26 zones representing Amherstburg;
- 7 zones representing the municipality of Essex;
- 2 zones are used for each of Kingsville, Leamington and Lakeshore;
- 31 zones representing the rest of Southwestern Ontario (Kent, Lambton, Middlesex and Elgin counties); these zones are based on current or former census subdivisions or municipalities; and,
- 7 zones representing the rest of Ontario and Canada.

In the United States:

- 322 zones representing Detroit and the northeastern portion of Wayne County, the areas closest to the Detroit-River crossings;
- 304 zones representing Dearborn and the northwestern and southern portions of Wayne County;
- 327 zones representing the counties of Livingstone, Macomb, Monroe, Oakland, and Port Huron/St. Clair.
- 6 zones representing the rest of the State of Michigan; and,
- 10 zones representing the rest of US and Mexico.

3. TRAVEL DEMAND

This section details the development of the base and future travel demands. The demands were prepared for the analysis time periods below.

3.1 Analysis Time Periods

New modelling periods were defined through the review of traffic profiles and to eliminate the limitations of a peak hour model such as peak spreading. They are defined as follows:

- A.M. Peak (6:00 a.m. to 9:00 a.m.);
- Mid-day (9:00 a.m. to 3:00 p.m.);
- P.M. Peak (3:00 p.m. to 7:00 p.m.); and
- Evening and Night (7:00 p.m. to 6:00 a.m.).

The total traffic volumes accumulated for the morning, afternoon and mid-day peak periods represent more than 75% of the total daily international traffic on a typical spring weekday and represent the highest traffic demand flows of the season.

3.2 Domestic Demand

Background domestic car and truck traffic is included in the model to simulate congestion effects on the Detroit-Windsor road network that will influence the travel speeds of international traffic. Domestic trip matrices used for the travel demand model were based upon the DRIC study. Canadian background traffic was derived from the City of Windsor travel demand model, while the US background traffic was derived from the SEMCOG model.

The domestic trip matrices were updated to represent 2008 traffic conditions through a linear interpolation of traffic volumes for every O-D pair between 2004 and 2015 trip matrices. Also, the domestic matrices were factored up to represent peak period volumes using the peak hour factors shown in Exhibit 3-1. Adjustments to the peak hour factors were made to address the changes in the domestic travel patterns that have not been updated since the original domestic trip matrices were created. The peak hour factors were calibrated to show a good fit of the model traffic assignments to the observed traffic counts as part of the validation process. Adjustments made to peak hour factors are explained by a reduction of local traffic volumes in the Detroit-Windsor area during peak and off-peak periods.

Exhibit 3-1 Peak Hour Factors for Domestic Matrices

Source	Period	Peak Period	SEMCOG/WALTS Peak Hour Factor	Windsor Gateway Peak Hour Factor
WALTS	A.M.	6 to 9	40%	40%
	Mid-day	9 to 3	21%	15%
	P.M.	3 to 6	42%	29%
SEMCOG	A.M.	6 to 9	55%	43%
	Mid-day	9 to 3	21%	14%
	P.M.	3 to 6	35%	26%

3.2.1 DOMESTIC FUTURE VEHICLES DEMAND

Future year domestic trip matrices were available for cars and trucks from the DRIC model for years 2015 and 2035. The 2025 trip matrices were created conducting a linear interpolation for every origin-destination pair between the 2015 and 2035 trip matrices. The growth rates fluctuate from 0.3% per annum for Canadian domestic traffic to 0.7% per annum for US domestic traffic between years 2008 and 2035. Domestic background traffic growth is consistent with population and employment growth rates expected for the Detroit-Windsor region.

3.3 International Vehicles

For the study, the international demand trip matrices for passenger vehicles and commercial vehicles were derived from survey data collected in the spring of 2008, as explained in detail in the following paragraphs.

3.3.1 INTERNATIONAL 2008 PASSENGER VEHICLE DEMAND

The passenger car trip matrices are based upon the 7,065 survey records from the passenger car survey database. The database is mainly constituted by 3,972 origin-destination surveys collected in the spring of 2008; however, the surveys were collected only for Canada-bound travel direction for the Detroit River crossings. Consequently, the survey database had to be complemented with 854 stated preference survey trip records and, 2,239 transposed US-bound trip records for the Ambassador Bridge and Detroit-Windsor Tunnel.

A customized query was built into the passenger car survey database to extract origin-destination data to construct the matrices. The customized query grouped origin-destination pairs along with the total number of trips segmented by border crossing and time period. A total of fifteen trip matrices were developed to represent the peak and off-peak passenger car travel patterns for the Ambassador Bridge, the Detroit-Windsor Tunnel and the Blue Water Bridge. Passenger car volumes are presented in Exhibit 3-2 for each trip matrix.

Exhibit 3-2 Spring 2008 Peak Period Volumes for Passenger cars

Crossing	2008 Spring Peak Period Volumes				
	A.M.	MD	P.M.	Evening & Night	TOTAL
Ambassador	2,550	3,560	3,190	3,350	12,650
Detroit-Windsor Tunnel	2,420	3,370	3,580	3,320	12,690
Blue Water Bridge	1,100	3,520	2,440	2,100	9,160
Total	6,070	10,450	9,210	8,770	34,500
	Percentage				
Ambassador	42%	34%	35%	38%	37%
Detroit-Windsor Tunnel	40%	32%	39%	38%	37%
Blue Water Bridge	18%	34%	27%	24%	27%
Total	100%	100%	100%	100%	100%

3.3.2 INTERNATIONAL 2008 COMMERCIAL VEHICLE DEMAND

The preliminary 2006 National Roadside Survey/Commercial Vehicle Survey (NRS/CVS) database, containing 3,931 trip records, provided the travel pattern data to construct the truck trip matrices for the Ambassador Bridge and Blue Water Bridge for both directions of travel. A customized query built in the survey database extracted origin-destination pairs and the number of trips segmented by border crossing and time period. A total of 10 trip matrices were developed using the extracted data from the customized query.

The 2006 NRS/CVS survey did not have a survey collection site at the Detroit-Windsor Tunnel. As a result it was necessary to return to the 1999-2001 CVS database, which was updated for the DRIC study, to obtain a reliable source of travel surveys at the tunnel. The data set provided 225 trip records to construct the Detroit-Windsor Tunnel trip matrices for both directions of travel. Expansion factors associated with each trip record, however, represented year 2004 traffic conditions and were scaled to represent year 2008 volumes. A query was built into the database to extract the travel pattern for commercial vehicles crossing at the tunnel. Trip matrices were imported into TransCAD. Exhibit 3-3 summarises the peak period volumes for commercial vehicles at the three border crossings.

Exhibit 3-3 Spring 2008 Peak Period Volumes for Commercial Vehicles

Crossing	2008 Spring Peak Period Volumes				
	A.M.	MD	P.M.	Evening & Night	TOTAL
Ambassador	1,440	3,460	2,440	4,520	11,860
Detroit-Windsor Tunnel	110	260	290	170	830
Blue Water Bridge	620	1,670	1,050	1,680	5,020
Total	2,170	5,390	3,780	6,370	17,710
	Percentage				
Ambassador	66%	64%	65%	71%	67%
Detroit-Windsor Tunnel	5%	5%	8%	3%	5%
Blue Water Bridge	29%	31%	28%	26%	28%
Total	100%	100%	100%	100%	100%

3.3.3 COMPARISON OF INTERNATIONAL VEHICLE DEMAND WITH PREVIOUS STUDIES

Exhibit 3-4 summarises a comparison between the peak period volumes converted to passenger car equivalent (PCE's) units for the Detroit-River crossings, segmented by crossing and direction of travel. The total volumes for the morning and afternoon periods represent the highest traffic conditions for international. The commercial vehicles total volumes are slightly higher during the mid-day period. The table also includes peak period volumes from summer 2000 providing the growth trends. Peak period volumes for an average weekday in spring 2008 have decreased by approximately 16% for the a.m. peak and 30% for the p.m. peak. A greater decrease was observed during the midday, falling 32% when compared to summer 2000 volumes. These figures indicate that traffic volumes have dropped significantly for the p.m. peak and off-peak periods, with a smaller decrease during the morning peak period.

Exhibit 3-4 Peak Period Volumes at Detroit-River Crossings, PCE's, Summer 2000 & Spring 2008

TIME PERIOD	AMBASSADOR BRIDGE		DETROIT-WINDSOR TUNNEL		DETROIT RIVER	
	to Canada	to US	to Canada	to US	to Canada	to US
Summer 2000						
Weekday A.M. Peak Period						
AVG. DAY Peak Hour (7:00-8:00)	1,003	1,927	359	1,021	1,361	2,948
AVG. DAY Peak Period (6 to 9 a.m.)	2,827	5,043	1,061	2,526	3,887	7,569
Weekday MD Peak Period						
AVG. DAY Peak Hour (12:00-13:00)	1,767	1,472	681	626	2,448	2,098
AVG. DAY Peak Period (9 a.m. to 3 p.m.)	9,952	8,674	4,341	3,675	14,292	12,349
Weekday P.M. Peak Period						
AVG. DAY Peak Hour (17:00-18:00)	2,519	1,396	1,136	665	3,654	2,060
AVG. DAY Peak Period (3 to 7 p.m.)	9,110	5,712	3,953	2,664	13,063	8,376
24-Hour Volumes						
AVERAGE DAY	33,689	29,641	13,986	14,000	47,675	43,641
Spring 2008						
Weekday A.M. Peak						
AVG. DAY Peak Hour (6:45-7:45)	723	1,673	173	774	896	2,447
AVG. DAY Peak Period (6 to 9 a.m.)	2,185	4,689	546	2,189	2,731	6,878
Weekday MD Peak Period						
AVG. DAY Peak Hour (1:15-2:15)	1,216	1,071	377	330	1,593	1,401
AVG. DAY Peak Period (9 a.m. to 3 p.m.)	6,757	7,191	1,995	2,153	8,751	9,344
Weekday P.M. Peak						
AVG. DAY Peak Hour (16:45-17:45)	1,583	1,227	914	349	2,497	1,576
AVG. DAY Peak Period (3 to 7 p.m.)	5,897	4,616	3,113	1,328	9,009	5,944
24-Hour Volumes						
AVERAGE DAY	23,662	24,584	7,876	7,258	31,538	31,842
Difference in Percentage Spring 2008/Summer 2000						
Weekday A.M. Peak						
AVG. DAY Peak Hour (6:45-7:45)	-28.0%	-13.2%	-51.7%	-24.2%	-34.2%	-17.0%
AVG. DAY Peak Period (6 to 9 a.m.)	-22.7%	-7.0%	-48.5%	-13.3%	-29.7%	-9.1%
Weekday MD Peak Period						
AVG. DAY Peak Hour (1:15-2:15)	-31.2%	-27.3%	-44.6%	-47.3%	-34.9%	-33.2%
AVG. DAY Peak Period (9 a.m. to 3 p.m.)	-32.1%	-17.1%	-54.0%	-41.4%	-38.8%	-24.3%
Weekday P.M. Peak						
AVG. DAY Peak Hour (16:45-17:45)	-37.1%	-12.1%	-19.5%	-47.5%	-31.7%	-23.5%
AVG. DAY Peak Period (3 to 7 p.m.)	-35.3%	-19.2%	-21.3%	-50.2%	-31.0%	-29.0%
24-Hour Volumes						
AVERAGE DAY	-29.8%	-17.1%	-43.7%	-48.2%	-33.8%	-27.0%

Notes: One commercial vehicle is assumed to be equivalent to three passenger cars. Summer 2000 peak period volumes represent a Thu-Fri average. Spring 2008 peak period volumes represent a Tue-Fri average.

3.3.4 INTERNATIONAL FUTURE PASSENGER CAR AND COMMERCIAL VEHICLES DEMAND

The international future trip matrices for horizon years 2015, 2025 and 2035, including passenger cars and commercial vehicles, were forecasted separately using the 2008 base year trip matrices as a stand point to be factored up by growth indexes. The base year trip matrices were segmented by trip purpose for passenger cars, i.e., same-day work/commuting trips, same-day other purpose trips and overnight trips; while the commercial vehicles were segmented by commodity type, i.e., auto, forest, animal/plant, metal, machinery/electronics, etc., and direction of travel, i.e., Canada-bound and US-bound traffic. The traffic growth indexes utilized to forecast the horizon year trip matrices are summarised in Exhibit 3-5 along with the per annum growth rates for each period. The corridor traffic growth forecast analysis, carried out for this study, provided growth indexes for passenger cars and commercial vehicles using a compatible segmentation with the trip matrices. The corridor growth forecasts are based upon a multivariate regression methodology that forecasts the value of vehicle traffic as a function of identified explanatory variables, and were developed separately for passenger cars and commercial vehicles. A more detailed explanation of the corridor growth forecasts can be found on the corridor growth forecast section of the report.

Exhibit 3-5 Growth Indexes for International Traffic

Vehicle Type	Growth Index				Per Annum Growth Rate (%)			
	2008	2015	2025	2035	2008-2015	2016-2025	2026-2035	2008-2035
Same-day Passenger Cars	1.00	1.43	2.00	2.52	5.3%	3.4%	2.4%	3.5%
Overnight Passenger		1.18	1.81	2.22	2.4%	4.4%	2.1%	3.0%
Commercial Vehicles		1.38	1.96	2.47	4.7%	3.6%	2.3%	3.4%

4. VALIDATION

4.1 Screenlines

Validation cordons are composed by a series of observation posts that are strategically set up on important traffic corridors to compare modelled traffic flows and observed flows. Three cordons were set up in the Detroit-Windsor area to validate the travel demand model performance, as shown in Exhibit 4-1. The cordons encircle a perimeter across highways, interstates and arterial roads used by traffic to access and exit the Detroit-River crossings on both sides of the Canada-US border. The first cordon, located in Detroit, sets a perimeter crossing seventeen observations posts located on highways and main roads including: interstates I-75, I-96, John C. Lodge Freeway, Chrysler Freeway and some major roads like Jefferson St., Grand River Ave., Grand Boulevard, and others. The cordon encircles main roads, close to the Detroit downtown area, which provide access and exit routes to traffic traveling to and from the border crossings. The second and third cordons are located in Windsor and delineate two long perimeters crossing fourteen highways and main roads including: Huron Church Rd., EC Row Expressway, Highway 401, Highway 3, Dougall Ave., Walker Rd. among other.

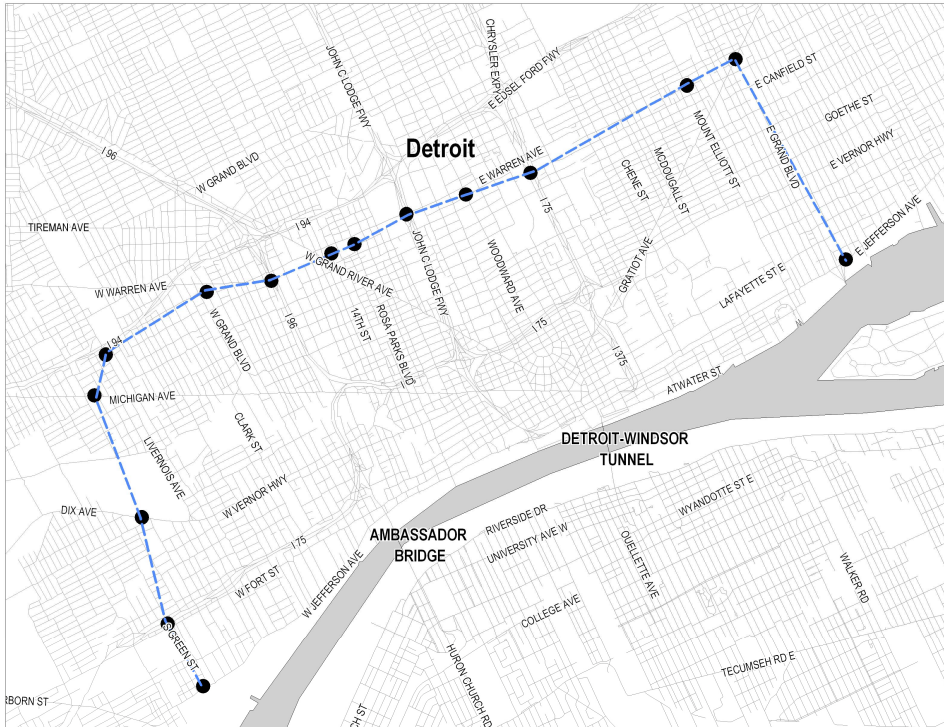
Traffic counts were collected on the observation posts in both Windsor and Detroit to compare modelled and observed volumes for model validation purposes. The main source of observed traffic data was given by field traffic counts conducted on dates during and shortly after the origin-destination survey implementation. Collected traffic data provided hourly vehicle volumes segmented by type of vehicle (passenger cars and trucks or for most cases only the total vehicles was provided) and direction of travel. At the moment of data collection, however, some important construction sites located in the US and Canada were in place in the proximity of traffic count sites, consequently affecting traffic volumes registered. The usual routes used by motorists to travel to the border crossings were being impeded by a partial or full closure of lanes, thus forcing motorists to detour for alternate routes. These construction sites are listed below:

- Ambassador Bridge Gateway Project: this project commenced on February 2008 and closed an important section of the interstate I-75 between Rosa Parks Blvd. and Clark St. and the interchange with interstate I-96.
- Road construction on Highway 401: the project commenced at the end of August 2007 and reduced the number of lanes from 0.4 kilometres east of Highway 3 easterly to 1.5 kilometres west of Manning Road.
- Road construction and separate structure rehabilitation of Big Creek Bridge: this project commenced on April 2007 and reduced the number of lanes of Highway 401 from Puce Rd. Easterly to 2.5 kilometres east of Essex County Road 27 and from 6 kilometres east of Highway 77 to 1 kilometre west of Essex County Road 42.
- Road construction in Windsor: construction projects in Windsor were in place including sites on the interchange of Dougall Parkway between Highway 401 and 6th Concession Rd., Walker Rd. from Parkdale Place to E.C. Row, Lauzon Rd. at C.N. tracks, and Division Rd. between Woodward Blvd. and Walker Rd.

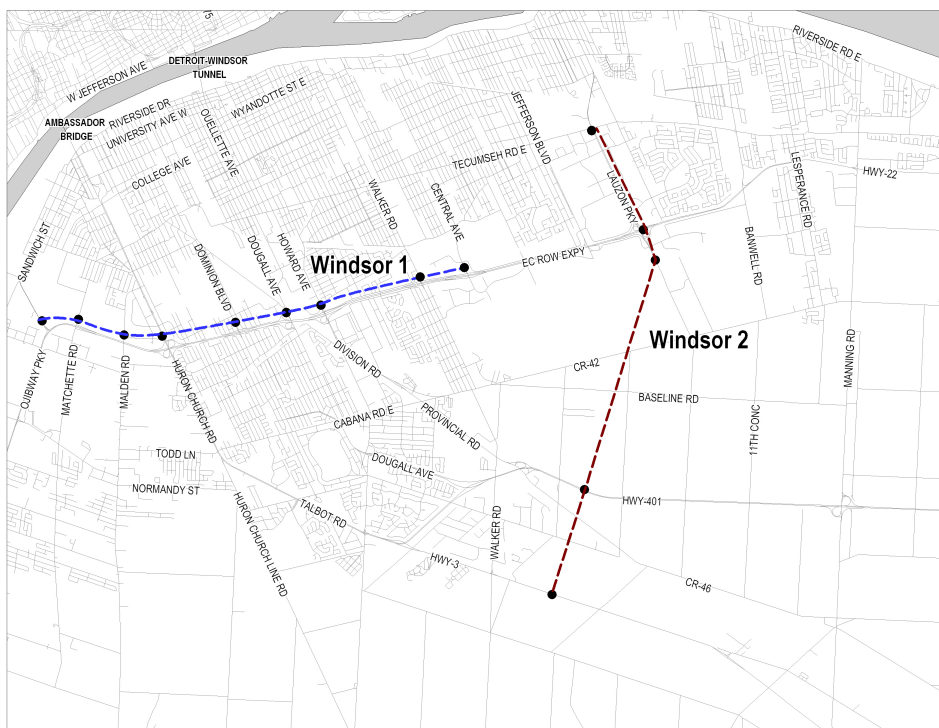
After a thorough analysis of traffic counts, it was decided to seek for alternate sources of traffic count data to substitute an important number of field traffic counts. The search focused on obtaining archive traffic counts during pre-construction traffic conditions, in order to obtain data under normal traffic conditions, i.e., no construction sites present. The search involved a thorough review of archive traffic counts provided by SEMCOG, MTO and the City of Windsor.

Exhibit 4-1 Detroit-Windsor Cordons

A) Detroit Cordon



B) Windsor Cordons



The City of Windsor provided pre-construction hourly traffic counts for most major roads in Windsor, however, some counts were obtained for older years and it was necessary to scale the traffic volumes to represent 2008 conditions. This task was completed using historic traffic counts also provided by City of Windsor for most locations that helped to scale volumes to year 2008. A comparison between field traffic counts and the City of Windsor counts, as illustrated in Exhibit 4-2, shows that the traffic counts are comparable at most cases with the exception of some locations that were affected by the ongoing construction during the data collection in spring 2008.

Exhibit 4-2 Total Volume Comparison Between City of Windsor and Field Traffic Counts

Count Locations	City of Windsor Count Total	WSA Counts Total
Ojibway Parkway	17,650	13,740
Machette Road	8,320	8,952
Malden Road	8,325	6,113
Huron Church Road	47,000	49,793
Dominion Road	18,342	20,810
Dougall Avenue	50,400	49,128
Howard Avenue	40,880	50,187
Walker Road	36,100	N/A
Central Avenue	35,625	50,627
Tecumseh Road	19,200	22,421
Total	281,842	271,769

MTO provided hourly traffic counts for Highway 401 for August 2007 close to the observations posts and carried out on periods before the construction projects started. SEMCOG provided a vast set of traffic counts for the interstates I-75, I-94 and I-96 in Detroit, however, available locations were far from the Detroit downtown area and away from the observation posts, so it was decided to keep the field traffic counts on US highways for validation. Modelled and observed volumes are presented in Exhibit 4-3 for the a.m., p.m., and mid-day peak periods.

Exhibit 4-3 2008 Cordon Validation

A) A.M. Validation

Cordon	Observed Volume 2008		Modelled Volume 2008		Mod /Obs	
	NB/EB	SB/WB	NB/EB	SB/WB	NB/EB	SB/WB
Detroit	41,328	54,755	38,983	56,423	0.94	1.03
Windsor 1	26,295	16,443	23,549	16,939	0.90	1.03
Windsor 2	10,173	13,781	8,784	15,716	0.94	1.15

Exhibit 4-3 2008 Cordon Validation (Continued)

B) Mid-day Validation

Cordon	Observed Volume 2008		Modelled Volume 2008		Mod /Obs	
	NB/EB	SB/WB	NB/EB	SB/WB	NB/EB	SB/WB
Detroit	103,483	110,300	97,757	104,496	0.94	0.95
Windsor 1	47,255	45,344	43,306	39,756	0.92	0.88
Windsor 2	23,433	24,956	26,286	28,837	1.12	1.16

C) P.M. Validation

Cordon	Observed Volume 2008		Modelled Volume 2008		Mod /Obs	
	NB/EB	SB/WB	NB/EB	SB/WB	NB/EB	SB/WB
Detroit	107,897	79,538	102,235	89,442	0.95	1.12
Windsor 1	31,527	40,257	31,297	36,443	0.99	0.91
Windsor 2	21,906	18,515	24,918	18,691	1.14	1.01

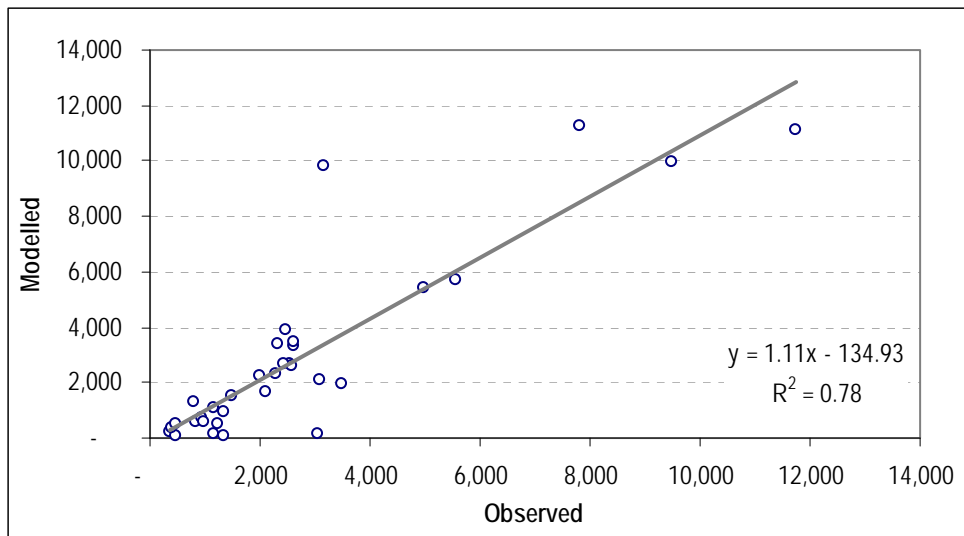
The total volumes accumulated in the cordons present an error less than 15% for all periods in most cases, complying with the general rule-of-thumb (i.e., errors should be below 15%), except during the mid-day period. Windsor cordon labelled as "1" performs satisfactorily in the total volumes entering and leaving the perimeter and Windsor cordon labelled as "2" performs satisfactorily for the a.m. and p.m. periods. The model presents a tendency to over-assign mid-day modelled volumes by 16%, however is not considered a threat for the model validation. In general the p.m. model performs better than the a.m. and mid-day models. This is explained partly because the domestic travel patterns were developed for the afternoon peak rush hour. Strategic facilities connecting the Detroit-River crossings in Windsor, Huron Church Rd. and E.C. Row Expressway, show a satisfactory adjustment in both directions of travel for a.m. and p.m. models. There is a somewhat larger deviation for the mid-day model on E.C. Row Expressway with a tendency to over-assign traffic.

The Detroit cordon performs satisfactorily when comparing the total volumes entering and leaving the cordon, presenting errors below the 15% for the a.m. peak, p.m. peak and mid-day period on both directions of travel. Some individual facilities, particularly freeways, showed some significant deviations. This fact, however, is consistent with previous findings in the DRIC study where it was found that the model presents a tendency to over-assign traffic volumes on freeways in Detroit. These deviations were escalated mainly due to effect of the construction sites over the field traffic counts that were used for validation, as explained in earlier paragraphs. Since the Ambassador Bridge Gateway Project was already in construction, traffic traveling on the south western portion of Detroit to the border crossings, that used to travel on the interstates I-75, I-94 and I-96, was being pushed off to the main arterials such as Michigan Ave., Dix St. and Woodward Ave, where it was observed that the model was underestimating the volumes.

The performance of the model can also be evaluated based on the fit between observed flows and modelled flows at thirty three observation posts in the Detroit-Windsor area. An ideal fitting for these data points would be a linear regression fit with a high goodness-of-fit, given by a line ($y=mx+b$) with slope "m" of value one (i.e. 45 degrees) and a constant "b" of zero (i.e. passing through the origin of the 'xy' axis). The linear regression results are shown in Exhibit 4-4 for the a.m. peak, mid-day and p.m. peak.

Exhibit 4-4 2008 Observed and Model-Predicted Link Volumes

A) A.M. Model



B) Mid-day Model

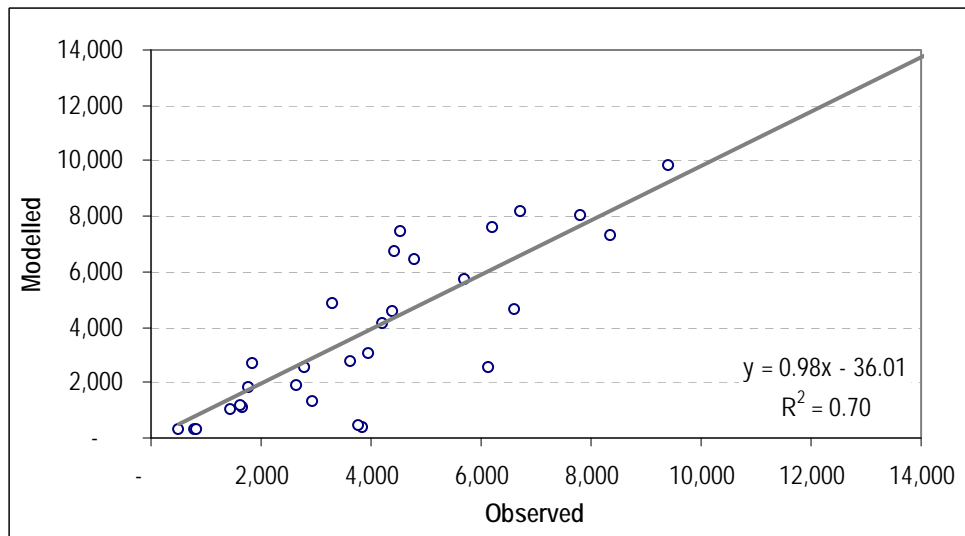
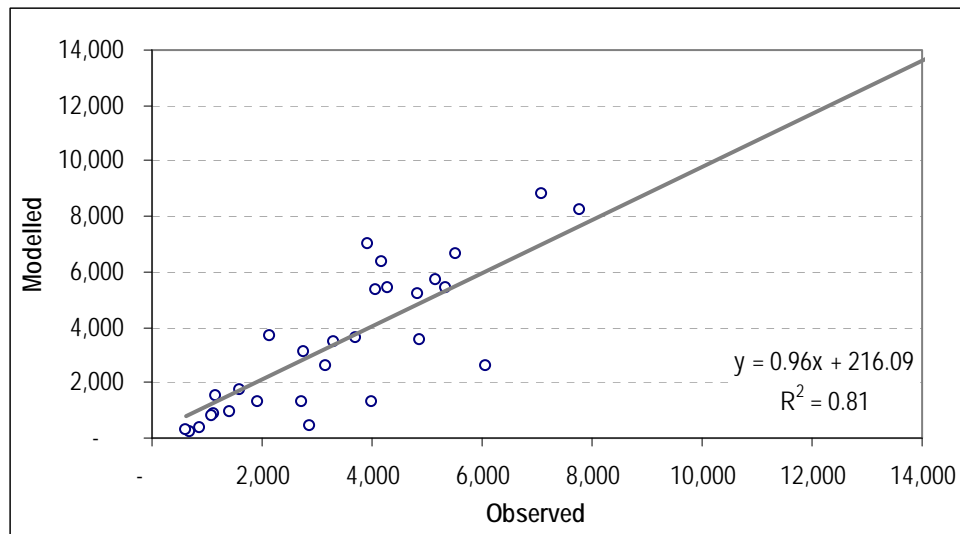


Exhibit 4-4 2008 Observed and Model-Predicted Link Volumes (Continued)

C) P.M. Model



During the p.m. peak, for which survey-based travel demand data were available, the line has a R2 of 0.81 and the slope of the linear function is 0.96. The a.m. and mid-day hours perform less well. During the a.m. peak, the model has a R2 of 0.78 and a slope of 1.11. During the mid-day period, the R2 falls slightly to 0.70 and the slope is decreased to 0.98. Overall, the modelled results provide a reasonable fit against observed traffic count data at the cordons.

4.2 Travel Times validation

A validation was conducted to evaluate the performance of predicted speeds and travel times of the travel demand model on both sides of the road network. Separate validations were conducted to evaluate the performance on the Windsor and Detroit portions of the travel demand model.

In the validation of the Windsor portion of the model, the passenger car DRIC travel time survey (conducted in February 2006) provided a source of travel times collected with probe vehicles travelling on the main access route to the Ambassador Bridge. The travel time survey focuses on the road segment of Huron Church Rd. between the E.C. Row and the Ambassador Bridge, because at this point the majority of drivers will select to use whether the Ambassador Bridge or the new crossing to cross the border.

Exhibit 4-5 presents the validation results for travel times (minutes) and speeds (kilometres per hour) for the road segment of Huron Church Rd. between E.C. Row and the Ambassador Bridge. The adjustment of modelled speeds and travel times is found satisfactory for the a.m. peak and mid-day periods, both directions of travel, with an acceptable degree of fit. The p.m. peak shows a larger deviation for travel times and speeds on the Canada-bound direction, that is, for traffic leaving the border crossings into Canada, which is not so critical, because motorists travelling in this direction already did the border crossing selection on the US side. The adjustment in the opposite direction, i.e., US-bound traffic traveling towards the border crossings, is close to one.

Exhibit 4-5 Travel Time and Speeds Validation - Windsor

Period	Observed (Huron Church Rd. Between E.C. Row & Ambassador Bridge)				Modelled (Huron Church Rd. Between E.C. Row & Ambassador Bridge)				Modelled / Observed			
	Travel Times		Speeds		Travel Times		Speeds		Travel Times		Speeds	
	To Can	To US	To Can	To US	To Can	To US	To Can	To US	To Can	To US	To Can	To US
A.M. Peak	3.8	3.8	53.7	53.7	3.9	4.0	53.0	51.1	1.01	1.05	0.99	0.95
Mid-day	4.2	3.8	49.2	53.7	4.0	3.9	51.0	52.3	0.96	1.03	1.04	0.97
P.M. Peak	6.0	4.0	34.0	51.0	4.6	4.1	44.3	49.3	0.77	1.04	1.30	0.97

The DRIC travel time survey was not conducted on the US portion of the model; therefore, travel times and speeds from the micro-simulation model developed for the Ambassador Bridge Gateway project by SEMCOG were used. The micro-simulation model evaluated the delays caused by the closure of the interchange of interstates I-75 and I-96 to assess traffic delay impacts. The micro-simulation model provided a source of year 2006 a.m. peak and p.m. peak travel times on specific posts within Detroit.

Exhibit 4-6 displays the control points from the micro-simulation model selected for validating the travel demand model. Four control points were selected to estimate observed travel times: (1) Ambassador Bridge, (2) Interstate I-75 south in the proximity of Hamtrack, (3) Interstate I-96 west in the proximity of Eliza Howell Park, and (4) Interstate I-75 north in the proximity of Southgate. The control points cover the main access routes to enter and exit from the Detroit River border crossings if traveling from the north, west and south of Michigan. Three travel movements were evaluated as follows:

- Ambassador Bridge to I-75 South;
- Ambassador Bridge to I-75 North; and
- Ambassador Bridge to I-96 West

Exhibit 4-7 shows the comparison results for travel times (minutes) and speeds (kilometres per hour) between the micro-simulation model and the travel demand model.

Each movement was evaluated in both directions of travel, i.e., to Canada (traveling towards the border crossings), and to US (in the opposite direction). Travel times and speeds between the micro-simulation model and the travel demand model were found to be satisfactory with a high degree of fit for most links.

Exhibit 4-6 Travel Time Segments for Detroit

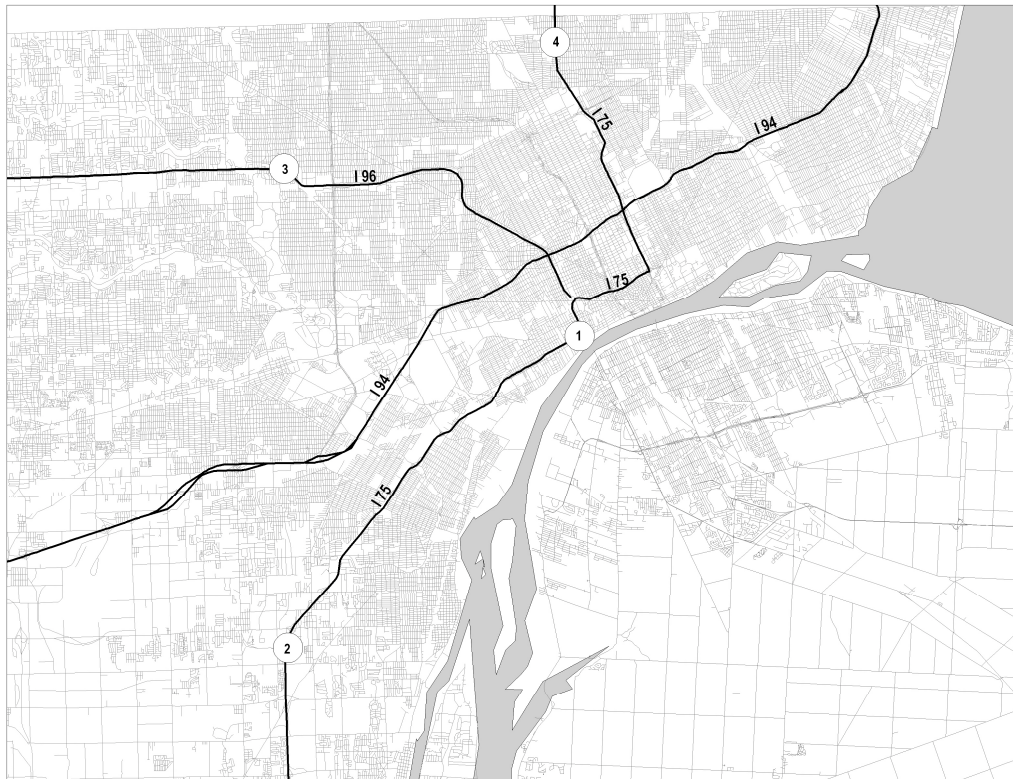


Exhibit 4-7 Travel Time Validation - Detroit

A) A.M. Peak

Movements	Micro-Simulation		Model Results		Model / Micro-Sim	
	To Can	To US	To Can	To US	To Can	To US
Ambassador Bridge (1) to I-75 South (2)	13.3	13.2	13.1	12.9	0.98	0.98
Ambassador Bridge (1) to I-96 (3)	14.8	13.8	14.3	13.5	0.96	0.98
Ambassador Bridge (1) to I-75 North (4)	14.7	16.8	14.3	15.2	0.97	0.91

B) P.M. Peak

Movements	Micro-Simulation		Model Results		Model / Micro-Sim	
	To Can	To US	To Can	To US	To Can	To US
Ambassador Bridge (1) to I-75 South (2)	13	14.7	13.1	13.3	1.01	0.9
Ambassador Bridge (1) to I-96 (3)	12.8	13.8	14	13.7	1.09	0.99
Ambassador Bridge (1) to I-75 North (4)	15.3	16.7	15.9	16.4	1.04	0.98

THIS PAGE INTENTIONALLY LEFT BLANK

APPENDIX **E**

PEER REVIEW REPORT

This appendix contains the documentation of the internal peer review report as provided by the subconsultant, IBI Group.

THIS PAGE INTENTIONALLY LEFT BLANK



Confidential Draft Report

Internal Peer Review of the
Comprehensive Traffic and Toll
Revenue Study for the Detroit River
International Crossing Project
Forecast Refresh and Update

**Submitted to Wilbur Smith Associates
by IBI Group**

February 2010

THIS PAGE INTENTIONALLY LEFT BLANK

1. Introduction

1.1 Report Purpose

The purpose of this report is to summarize the findings of an internal peer review performed by IBI Group on the traffic and revenue forecasts for the Detroit River International Crossing (DRIC) Study, as prepared by Wilbur Smith Associates (WSA) for the Michigan Department of Transportation (MDOT).

The internal peer review involves a review of the assumptions, methodology and results of the DRIC traffic and toll revenue forecasts and includes a review of data validity, economic parameters, travel demand procedures and parameters and toll rate sensitivity analysis. The objective was thus to assess the credibility, reasonableness and any associated risks with the forecasts and their reliability with respect to supporting informed decision-making by MDOT. As an internal peer review, IBI Group was part of the WSA Team responsible for the development of traffic and revenue forecasts and thus was involved in discussions with WSA throughout the study. Given the aggressive time schedule, this was beneficial as IBI Group was able to provide timely input on assumptions and methodology, allowing refinements to be incorporated into the development of the WSA forecasts as required.

1.2 Internal Peer Review Process

IBI Group is a leading transportation consulting firm that includes specialties in the areas of transportation planning, travel demand forecasting and toll forecasting. The firm has been responsible for the development of traffic forecasts for the Detroit River International Crossing over the past decade, supporting major US-Canada Bi-national Partnership efforts as part of the Planning/Need and Feasibility Study (2004) and the DRIC Study (2007), and undertaking several Windsor Gateway traffic analysis studies for Transport Canada and the Ministry of Transportation, Ontario (MTO). IBI Group was also part of the WSA Team that prepared the draft Investment Grade Windsor Gateway Traffic and Revenue Study for Transport Canada (2008). IBI Group has also undertaken toll traffic and revenue studies and peer reviews for toll facilities across North America and abroad, and thus provides the historic understanding and technical skills necessary to be uniquely qualified to perform an internal peer review of WSA's DRIC Refresh for MDOT.

The internal peer review was initiated with the notice to proceed provided to WSA by MDOT. As part of the WSA technical team in the Windsor Gateway investment grade study, IBI Group's role in the MDOT Refresh included providing input and updates to networks, trip tables and assumptions, continuing this role from the previous Windsor Gateway study.

The following tasks, meetings and document reviews formed the basis for the internal peer review:

- Draft Investment Grade Level Toll Traffic and Revenue Forecasts for the Windsor Gateway for Transport Canada, prepared by WSA

in association with IBI Group, Resource Systems Group and the Centre for Spatial Economics (C4SE)

- Comprehensive Traffic and Toll Revenue Study for the Detroit River International Crossing Project Forecast Refresh and Update, including:
 - Work Plan
 - Executive Summary, December 15, 2009
 - Participation in Progress Meetings with MDOT
 - Slide Presentations
 - Participation in weekly internal WSA team progress meetings
 - Review of select tables and exhibits prepared by WSA for inclusion in the draft final report
 - On-going discussions and feedback to WSA as appropriate

The starting point for the internal peer review was IBI Group's independent review of the investment-grade level Windsor Gateway Study, with the added benefit of hindsight and in view of knowledge of recent events and trends since the draft report was completed. IBI Group was able to validate the 2008 forecasting process against the current year's data (2009), which provided the ability to check and verify the predictive ability of the forecasting process against key parameters, as well as comment on the potential risk and uncertainty areas previously identified. This review, as well as IBI Group's familiarity with and understanding of the DRIC project from the P/NF and DRIC studies, provided the basis for the refinement suggestions in the DRIC Refresh summarized in the next chapter.

2. Review of Methodology

2.1 Background

The study of a new road-based international crossing of the Detroit River has been on-going for the past several decades. As noted above, the P/NF and DRIC environmental studies laid the groundwork to establish the DRIC project, which constitutes a new international bridge with high-speed, grade-separated connections linking Highway 401 in Windsor to I-75 in Detroit. The modeling platform, approach and methodology for traffic forecasting were originally established as part of the P/NF study in 2002. This original modeling framework has been applied in subsequent DRIC studies, including the current DRIC Refresh for MDOT. While the DRIC modeling framework has remained largely unchanged, the modeling techniques have evolved to capture new data that better reflect individual travel preferences in the context of the complex and dynamic aspects of cross-border travel.

The initial P/NF modeling process was developed in 2002, soon after the events of 9/11, amid much uncertainty surrounding the implications on long-term traffic trends. At the time, 2000 was the only practical base year for travel demand analysis, as data from 2001/2 were considered to be distorted by the events of 9/11, and major data collection efforts that were to provide key inputs to the modeling process were undertaken in previous years. This included a 1999 auto intercept survey of international travellers between Michigan and Ontario, the 1999 commercial vehicle survey, the 2000 US Census, and the 2001 Canadian Census among other data sources. It was recognised that 9/11 and other events might have long-reaching impacts which may have structurally changed cross-border travel demand in the study area and increased the level of uncertainty in the travel demand forecasts. As such, many sensitivity analyses were performed in the P/NF, some of which included a 2002 base year, which meant that the forecasts started from a much lower level of traffic than existed in 2000.

Subsequent DRIC studies were undertaken by US and Canadian authorities to obtain environmental approvals for a new crossing, which provided the opportunity to update the traffic forecasting and modeling process and, through it, better incorporate the most current knowledge on the impacts of 9/11, other extreme events since the P/NF Study (e.g. the War in Iraq, and SARS), changing socio-economic trends (e.g. Canada-US exchange rate, fuel prices), the opening of casinos in the Detroit area, and other changes in attitudes on cross-border travel behaviour. The update took into account the traffic and trade data (2004), which revealed that cross-border passenger car traffic had declined dramatically in the study area, while commercial vehicle traffic continued to grow. A new 2004 base year was established for the DRIC modeling process, even though no new origin-destination surveys were undertaken, requiring that the update of travel demand be based on the previous 1999/2000 surveys as employed in the P/NF Study, but with adjustments through extensive analysis of available data and statistics available to 2004. As such, trip tables for international traffic were revised to reflect 2004 traffic counts by vehicle class and time of day, with independent controls on the type of goods carried by commercial vehicles and separate surveys to best capture trip purpose for passenger cars.

2.2 DRIC Modeling Process

The DRIC modeling framework applied in the DRIC refresh, as shown in Exhibit 2-1, is comprehensive, multimodal and captures passenger travel and goods movements between southwestern Ontario and southeastern Michigan as well as local background and domestic travel. It provides a detailed representation of the road network over this geographic area with sensitivity to time and costs for crossings over the Detroit and St. Clair Rivers, and includes urban traffic model detail within the metropolitan Detroit and Windsor areas. The model coverage also extends to major regional areas throughout the rest of North America to capture long distance goods movement flows and recreation/vacation travel. The modeling process also stratifies and segments key cross-border markets to capture different travel characteristics and flows. For passenger travel, same-day work/business, other same day, and overnight trips are reflected, while commercial vehicle flows reflect major commodity groups.

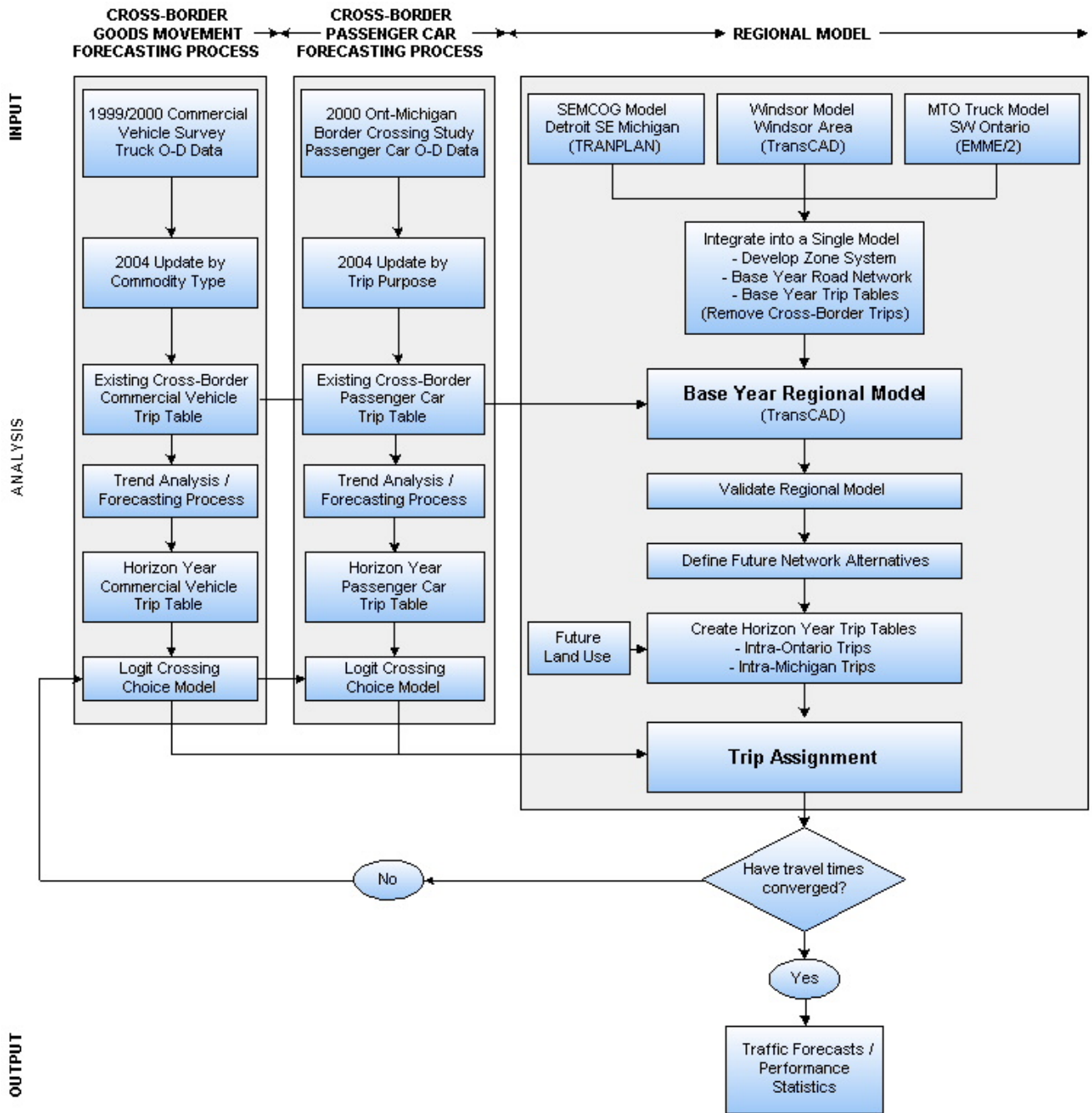
The DRIC modeling process provides a sound basis for the DRIC Refresh, given the review and scrutiny it has received during its evolution since 2002. The model was extensively peer reviewed during the P/NF and DRIC studies, with transportation demand modeling experts from MDOT, MTO and FHWA forming a DRIC modeling group to review and provide input to all aspects of the forecasting and modeling process. There has also been extensive review and comment by other stakeholder groups throughout these studies. In addition, an independent assessment of the DRIC modeling process by FHWA also concluded that the techniques were sound and reasonable, employing methods representing the state of practice.

2.3 DRIC Refresh

The DRIC Refresh represents an update of the Investment-grade level Windsor Gateway Study undertaken for Transport Canada in 2008, with new data over the 2008 to 2009 period incorporated to capture recent events, notably the major recession, financial crisis and downturn of the Detroit auto-makers over this short period.

The 2008 investment-grade level study provides a new baseline to work from for the DRIC Refresh and represents a major update of the DRIC modeling process. This included a major new data collection effort given that the previous approach was based on adjusted 1999/2000 origin-destination data and improved behaviour-based methods to estimate crossing choice among users of bridge and tunnel crossings of the Detroit and St. Clair Rivers. A 2008 base year was established for the investment-grade Windsor Gateway study, and included a major new data collection effort to ensure that current and comprehensive data were available on which to base traffic forecasts and meet the needs of an investment grade study.

Exhibit 2-1: DRIC Model Flowchart



As such, the DRIC modeling process was updated for the Windsor Gateway study by incorporating:

- current origin-destination survey data, counts and speed/delay studies for passenger cars and commercial vehicles;
- recent information on transportation and economic trends;
- an enhanced crossing route choice model based on stated preference surveys; and
- the latest economic, socio-economic and land use projections to produce new forecasts using the updated model.

Crossing Choice Model

The original DRIC modeling process included a binomial logit model to estimate the proportion of passenger car and commercial vehicle traffic using the Detroit River versus St. Clair River crossings for international travel between southwestern Ontario and southeast Michigan. This crossing choice model was calibrated to observed travel characteristics for travelers using the Detroit River and St. Clair River crossings, but was not able to predict the Ambassador Bridge versus the new DRIC crossing since there were no calibration data available. This limitation was recognized as part of DRIC study and a recommendation of the FHWA peer review was to develop a nested logit model based on stated preference surveys.

The investment-grade level Windsor Gateway Study undertook stated preference auto and truck surveys to develop a new choice model to estimate the proportion of traffic using each Detroit River and St. Clair crossing (i.e. traffic split between the Ambassador Bridge, Detroit-Windsor Tunnel, Blue Water Bridge and the DRIC crossings). Stated preference surveys provide a means of capturing potential user preferences and biases for a new facility that does not presently exist by asking individuals who make cross-border trips hypothetical questions about their preferences for the various crossing options and the combinations of toll levels and travel times they would consider using the new crossing.

A review of the stated preference survey design, conduct and methodology, as well as the resulting logit-based choice model structure, was performed. This review confirmed that the resulting models have a sound statistical basis with intuitive appeal, strong sample sizes, and robust variables. In addition, sensitivity tests were performed to verify the reasonableness of the model. The parameter values, signs and imputed values of time derived from the crossing choice model were within reasonable ranges. The value of time derived for the passenger model was found to be \$10 per hour, which is considered by the review team to be at the lower end of the range compared to values typically found for toll road facilities in urban areas, especially given the higher auto occupancies generally exhibited for cross-border travel. A higher value of time would tend to favour the new DRIC crossing due to the travel time savings provided.

As part of the choice model development, two basic formulations were tested and results presented: a nested logit approach that reflects a two-step decision

process (i.e. choose Detroit versus St. Clair River at an upper nest, with the lower nest determining the individual crossing); or a multinomial process where choices between all four road-based international crossings are examined simultaneously in a single level. There was some concern on the part of the reviewers that the multinomial formulation might not satisfy the Independence of Irrelevant Alternatives (IIA) assumption, with two alternatives being highly dependent upon each other, thus producing misleading results. However, a careful review of the multinomial and nested logit models indicated that no such problem existed and that the relative differences in the results between the two approaches were not significant.

Based on the review of the choice models, it is felt that the models are consistent with the state of practice and provide a solid behaviour-based approach to estimate individuals' choice of crossing based on travel time, operating cost and tolls, and non-quantifiable factors such as ease of travel, reliability and amenities. In addition, given the trade-off questions involving tolls/costs presented in the survey, it is felt that the resulting choice model also provides a sound basis for revenue estimation from crossing tolls and sensitivity analysis of revenue and traffic to different toll levels.

Forecasting Methods

The investment-grade level Windsor Gateway Study and DRIC Refresh employed multivariate regression to project future growth in same day passenger car, overnight passenger car and commercial vehicle demand based on historic cross-border traffic levels and various independent variables such as population, employment and trade. The projection of future traffic based on three passenger car and one commercial vehicle market segments reflects some aggregation of markets relative to the DRIC study, in which three passenger car markets (work/business, same-day other, overnight) and five commercial vehicle markets based on commodity groups (automotive and metal, machinery and equipment, forest, agriculture, other commodities) were identified. The rationale for the greater market segmentation in the DRIC study was that the different market groups were projected to grow at different rates and that each market group had different origin-destination patterns, as revealed through the origin-destination surveys. The DRIC study also developed regression equations to project future demand for each market, but opted for a more flexible approach based on identifying causal factors (similar to those used in the regression) that allowed more professional judgment into the process given the many non-quantifiable uncertainties and perceptions that have influenced cross-border travel in past. A comparison of the DRIC study regression equations versus the causal factor approach did not indicate significant differences at the time thus mitigating concerns about the use of regression techniques with the DRIC Refresh.

While a different and slightly more aggregate approach is used in the DRIC Refresh compared to the original DRIC study, the two approaches are consistent in their general philosophy, in that distinct markets are identified while the respective techniques use similar independent variables and growth rates to project future passenger car and commercial vehicle demand, pivoting from an observed base-year trip table.

Traffic Operations

A major challenge in forecasting demand for the Detroit River crossings is the small travel time and distance difference between the Ambassador Bridge and the proposed new DRIC crossing. The DRIC modeling approach uses a macro-model-based platform, with the trip assignment process using link-based equilibrium traffic assignment techniques. Macro models are used in regional/metropolitan planning applications, and the assignment capabilities are generally considered appropriate for a corridor level of accuracy but do not fully capture traffic operations impacts such as traffic signal delays, queuing delays, merge/weaving effects, on/off ramp delays and other such aspects in a detailed and comprehensive manner. Thus, there was concern that the macro-model approach, which uses a simple volume-delay function (VDF), could result in some underestimation of traffic operational delays and possibly indicate differences greater than the less than 3-minute travel time differences estimated between Ambassador and DRIC crossing routings for a range of cross-border paths. As such, it was important to have confidence that the network coding associated with each crossing alternative was accurately depicted, included its speed/capacity relationships and free-flow speeds. To ensure that reasonable travel times were obtained, the DRIC Refresh undertook speed and delay studies for approach roads leading to the Detroit-Windsor crossings and are reflected in the network coding. The DRIC and Ambassador Gateway projects were also carefully coded to account for their presence in the future road networks.

While every reasonable attempt was made to represent accurate travel times within a macro model framework, there are limitations of such an approach. Often, macro models are used together with micro-simulation or traffic software, similar to the Level 2 and 3 traffic analyses undertaken for the DRIC study which involved Synchro-level analysis and VISSIM micro-simulation techniques, respectively. As part of the internal peer review, speed and travel time from these previous DRIC traffic analyses were compared to the DRIC Refresh level of service on alternative cross-border paths. A comparison of the travel times between Ambassador Bridge and DRIC crossing paths is provided in Section 4.2.

3. Review of Assumptions

The DRIC Refresh forecasts are based on a number of factors, including assumptions about population and employment, transportation networks, passenger cars, economic and cost. In general, the main input variables and assumptions used in the DRIC Refresh are similar to those used in the previous DRIC study, but updated to reflect 2009 conditions. Given the peer review of the DRIC and P/NF modeling processes performed previously, the data sources used and the level of detail of this data were previously examined and found to be the best data available to the forecasting team at the time. As such, use of many of the same data sources for the 2009 Refresh provides confidence in this area.

3.1 Macro-Economic

Commercial vehicle growth forecasts are highly tied to projected US GDP and the US/Canada exchange rate, with very high correlations found in the multivariate regression equations developed. To capture a future range of projections, economic projections from several sources were obtained for the DRIC Refresh, including the Conference Board of Canada, Informetrica and Global Insight, as provided by Transport Canada. In addition, long-term US GDP forecasts developed by the Centre for Spatial Economics (C4SE) were also examined, and used to project Ontario trade turn-over, and ultimately, commercial vehicle traffic growth. The C4SE projections were comparatively more conservative than the other sources, falling at the bottom to middle range of the set of projections, translating to strong growth over the next several decades and reflecting the strength of the American economy over this period. The C4SE projection was also selected since it represented a more current update of existing economic conditions relative to the other acquired forecasts. In terms of near-term growth, all of the projections assume that the economy and US-Canada trade has essentially bottomed out with the 2009 recession with ensuing growth thereafter.

While economic projections are subject to considerable uncertainty, the growth of US GDP has been relatively consistent over the long term and provides a sound basis for long-term forecasting. The fact that the C4SE projection is in the lower range of a group of respected projections suggests reasonableness of the forecasts and degree of conservatism. The economic projections used in the previous DRIC study were based on Informetrica forecasts, with the current Informetrica projections marginally higher than that of the C4SE.

An area of interest not explicitly captured in the economic projections is the impact on the automotive sector. The Detroit/Windsor and Michigan/Ontario economies are highly sensitive to this sector, which has been a prime victim of the recent economic turmoil and significant future uncertainties. In the previous DRIC study, automotive was one of five commodity groups, with each group having a separate forecast growth based on Informetrica's projection for that group. The economic projection for the DRIC Refresh aggregated all of the commodity groups, and as such the automotive sector was assumed to grow in line with the rest of the American economy.

3.2 Population and Employment

The DRIC modeling process covers the Detroit and Windsor regional areas within the US and Canada at a traffic analysis zone level of detail. Existing and future population and employment forecasts were obtained from SEMCOG and the City of Windsor, reflecting the most recent land use data available for these jurisdictions. The traffic zone level of detail within Detroit and Windsor reflecting their expected growth is important given that relative travel time savings associated with the DRIC crossing are very sensitive to the origin and destination within these urban areas. The SEMCOG forecast for Detroit indicated reduced future population relative to the Windsor Gateway study, while the City of Windsor projections were unchanged. In addition, Ontario and Michigan-level population and employment projections were also obtained from state and provincial agencies.

An independent market forecast for these areas, as developed by WSA and the C4SE, was comparable in magnitude and provided reasonable confidence that it reflected a realistic future scenario rather than a politically-oriented projection.

3.3 Traffic Counts

Traffic count data collected for the DRIC Refresh were provided to IBI Group in raw and summarized formats. The traffic counts were collected for the road-based crossings and at select locations within Detroit and Windsor. This sample was considered reasonable given that complete 2008 screenline data was obtained for the Windsor Gateway study, verifying the limited changes over this one-year period.

3.4 Trip Tables

The trip tables for commercial vehicle and passenger car travel were based on the origin-destination surveys performed for the Windsor Gateway Study, but re-expanded to new traffic counts by vehicle class, as collected for the DRIC Refresh study. The re-expansion of the trip tables was undertaken by passenger car trip purpose (3 categories) and commercial vehicle commodity group (5 categories), consistent with the expansion approach used in the DRIC study also undertaken by IBI Group to ensure consistency in the process. The expansion process also required a review of the traffic count data collected in 2009, with comparisons made to 2008 and previous DRIC count data. IBI Group also undertook the expansion of the base year trip tables to reflect future conditions based on growth factors derived from the multivariate forecasting approach.

3.5 Road Network

The base year and future year road networks were updated to reflect changes in the capital improvement plans for SEMCOG and the City of Windsor over the past year. IBI Group was responsible for the original update of the networks as part of the 2008 Windsor Gateway study and reviewed the list of road improvements incorporated into the model for the Refresh study. The critical road access facilities to the DRIC crossing are part of the DRIC project and thus the risk and dependence of the crossing on other facilities being constructed is not a concern.

3.6 Toll Rates

The toll rates assumed for passenger cars and commercial vehicles were based on existing toll rates with an initial ramp-up followed by future escalation growing in line with inflation. The current charging scheme based on the size and weight of the vehicle and the relative cash/token rate was assumed to be carried forward in the future with escalating average rates among the car and commercial vehicle categories. Toll rate escalation was calculated based on the average of CPI rates over the past 10 years, equating to an average compound rate of 2.3%. This escalation is considered to be conservative based on an analysis of toll rate increases since 1989 which show average toll increases from 1989 to 2009 of 5.3% for the Detroit-Windsor Tunnel, 6.0% for the Ambassador Bridge, and 3.5% for the Blue Water Bridge. This approach is sound given that there is little basis to predict continued higher-than-CPI toll rate increases in light of economic uncertainty and the increased competition that would be provided by the new crossing. It was assumed in the base forecasts that the new DRIC crossing would have an identical toll rate as the Ambassador Bridge; a reasonable assumption that reflects a pricing equilibrium between the two competing crossings, although some “price wars” or predatory pricing could occur over short durations.

The ramp-up refers to the crossing’s performance during its early years of operation with high traffic growth as it becomes operational and ending when the annual growth stabilizes. The ramp-up period is related to user’s unfamiliarity with the new facility and potential reluctance to pay a toll or increased toll. WSA assumed a relatively short ramp up period (90% in the first year and 95% in year 2), which is considered reasonable and somewhat conservative due to the tremendous familiarity of the project, and of the clear convenience benefits in accessing the new facility.

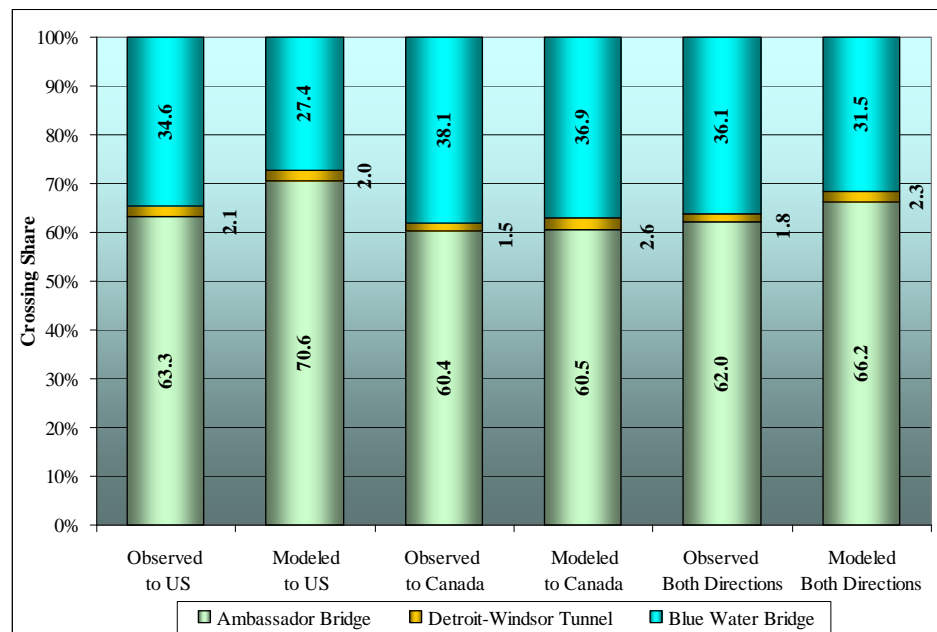
4. ASSESSMENT OF TRAFFIC FORECASTS AND SENSITIVITY TESTS

4.1 Model Validation

The use of the 2008 crossing choice model parameters applied using 2009 data provided a unique ability to validate the model using data that was independent to the calibration data. It was found that the passenger model validates well and that there were no calibration adjustments needed. Due to the larger systemic economic changes that occurred over the 2008-2009 time-frame, the commercial vehicle crossing choice model did not validate as well when applied to 2009 data and showed a significant over-prediction of Ambassador Bridge traffic. This over-prediction is seen in the US-bound direction for all time periods, and is most prominent in the a.m. peak period as shown below in Exhibit 4-1. The commercial vehicle crossing choice model was then recalibrated with minor changes to better reflect the crossing patterns as seen from the 2009 traffic counts collected as part of the Refresh study.

Similar validation exercises were completed for the corridor growth regression models, and found that the parameters retained their strong explanatory powers when applied to the 2009 data as an independent check.

Exhibit 4-1: A.M. Peak Period Commercial Vehicle Validation Results with 2008 Calibrated Crossing Choice Model

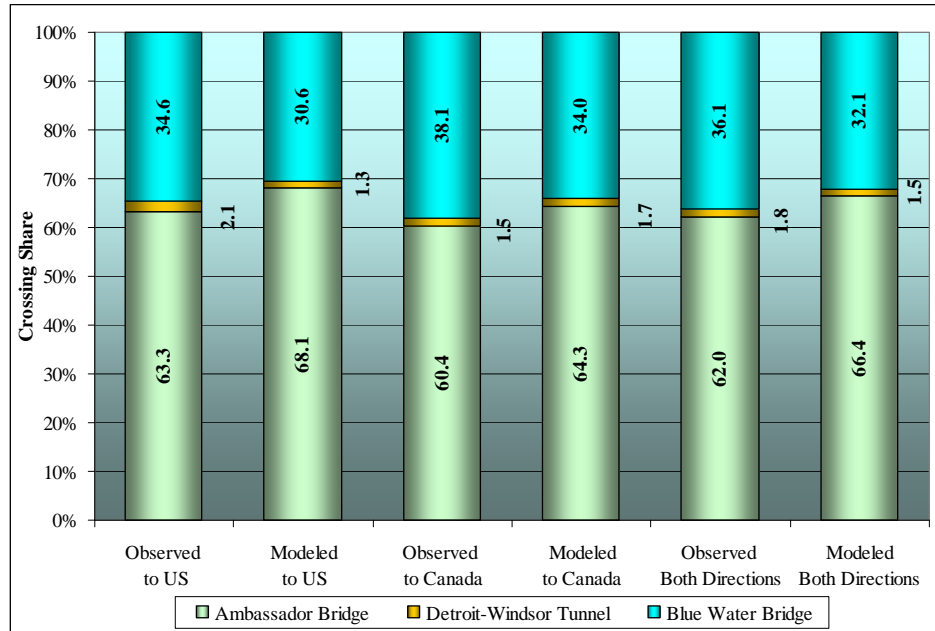


4.2 Model Calibration

WSA underwent a detailed re-calibration of the DRIC model to reflect the newly collected 2009 data from including traffic counts at each of the border crossing locations and the latest set of social and economic indicators. As noted above, in recalibrating the crossing choice models, it was found that the passenger model transferred well to the 2009 base year while the commercial vehicle model required some recalibration to account for a systemic over prediction of Ambassador Bridge crossings at the expense of the Blue Water Bridge.

In order to calibrate the crossing choice model to the 2009 base year conditions, the bias constant for the Ambassador Bridge was adjusted to better match the observed crossings shares resulting in the 2009 calibrated crossing shares as shown below in Exhibit 4-2. Varying improvement of the calibration results is reflected among the four modeling time periods. The calibration approach is confirmed to be sound, with WSA choosing to keep the explanatory parameters for time and cost consistent with the 2008 model. Only the bias constants were refined to better replicate the observed shares. The difference between observed and modeled crossing shares for the Ambassador Bridge to the USA ranges from 4.8 percentage points in the a.m. peak period to 3.7 point in the mid-day period, 2.7 points in the a.m. peak period, and 1.9 points in the evening and night period (refer to Figure 5-15 in the WSA report). In general, modeled crossing shares in the Canada-bound direction match observed shares to a closer tolerance. These differences reflect a model that has been calibrated within an acceptable tolerance without compromising the explanatory power of the original crossing choice model specification.

Exhibit 4-2: A.M. Peak Period Commercial Vehicle 2009 Validation Results



In developing the updated corridor growth forecasts, it was found that the regression model relationships developed previously continued to calibrate well with the new 2009 data. Some adjustments were made to the corridor growth forecasts including a 20-30% reduction of same-day passenger car traffic and a 35% of overnight passenger crossings that will continue to be deterred by more stringent cross-border security measures.

Overall, the DRIC Refresh model calibration results show an excellent model calibration, well within the tolerance needed to perform comprehensive forecasting work. This calibration is shown at both the overall crossing level, as well as at the superzone origin-destination level for both the passenger and commercial vehicle models across all time periods.

4.3 Travel Time Analysis

One of the primary areas of concern identified early on in the refresh process was the modeled travel time savings under build scenarios when comparing the new crossing with the Ambassador Bridge. To address this concern, WSA and IBI worked closely together throughout the Refresh period to ensure that the crossing choice model was accurately capturing the travel time benefits of the new crossing. As noted in Section 2.3, the principal concern was that due to the link-based (VDF) assignment used in the macro model framework, travel times would be underestimated along Huron Church Road leading to the Ambassador Bridge. Link-based assignment methods are known to poorly capture traffic operational impacts such as traffic signal delays at Huron Church Road and the new DRIC highway access facility on the Canadian side.

A series of independent checks were performed as part of the peer review process to obtain a comfort level with the speeds and travel times. There are two primary sources for checking the travel times in the DRIC Refresh model: the VISSIM simulations completed as part of the DRIC Level 3 Traffic Analysis and the travel time surveys completed for the initial model calibration for the Windsor Gateway study in 2008. The first travel time check looks at the travel time from Huron Church Road at EC Row to each of the respective crossings. This section is particularly important since the Ambassador Bridge route via Huron Church Road has numerous traffic signals in addition to local Windsor traffic being compared with a high-speed grade separated highway facility for the new DRIC Crossing.

As part of the previous Level 3 Traffic Operations Analysis, travel time comparisons were completed using VISSIM simulations from east of the Hwy 401/Hwy 3 interchange to the new crossing and the Ambassador Bridge. The simulations are able to capture route details including ramp delays exiting from the new freeway to Huron Church Road when accessing the Ambassador Bridge. A comparison of modeled travel time savings with the travel time savings found in the VISSIM simulations is shown in Exhibit 4-3. In the a.m. peak period, the DRIC Refresh model predicts that one can reach the new border crossing in 2.2 fewer minutes than it would take to reach the Ambassador Bridge, compared with a difference of 2.3 minutes predicted in the VISSIM simulations. The travel time difference remains at 2.2 minutes in the p.m. peak period, while the VISSIM simulations show an increasing differential due to more queuing and delays occurring on Huron Church Road. In general, these results indicate that the DRIC Refresh model is slightly on the conservative side when predicting travel

time differences between access to the new crossing and the Ambassador Bridge, particularly in the p.m. peak period. While differences exist, in general these results indicate excellent travel time accuracy given the limitations of link-based assignments

Exhibit 4-3: New Crossing vs. Ambassador Bridge Access Time Savings from Huron Church/EC Row

Source	Period	
	A.M.	P.M.
Refresh Model	2.2 min	2.2 min
DRIC VISSIM	2.3min	3.2min

The modeled travel time differential corresponds to an average speed of 33 mph to the Ambassador Bridge and 56 mph to the new crossing. The travel speed to the Ambassador Bridge is slightly slower than the 40 mph speeds recorded in the 2008 travel time calibration surveys, consistent with an increase in traffic congestion along Huron Church Rd in the 2035 horizon year. The final test on travel time differentials looks at the total time savings between Highway 401/Highway 3 in Windsor and I-75/Pennsylvania Road, west of the new crossing in Detroit. The modeled results indicate a total travel time savings for the new crossing for this interchange of 2.7 minutes in the morning peak and 3.5 minutes in the afternoon peak due to the more direct path and higher average speeds. This travel time comparison shows that the DRIC Refresh model compares well with the more rigorous VISSIM analysis and that the travel times for the DRIC Refresh are only slightly on the conservative side, but in general are an excellent estimate of expected travel time differentials in the corridor.

4.4 Bridge Crossing Shares

With the base year calibration of the crossing choice model established, the next question to be reviewed is whether the model produces reasonable estimates of crossing shares in future horizon years with the new crossing in place. Exhibits 4-4 and 4-5 show the change in crossing shares in 2035 for the commercial vehicle and passenger models. The first level of interest is the split between the St Clair River and Detroit River crossings. The Blue Water Bridge share has increased for commercial vehicle traffic destined to the US, and has decreased for commercial vehicle traffic headed to Canada. The St. Clair River shares fall within a reasonable range, and also remain consistent with previous DRIC (2005) modeling efforts that found 35% and 25% Blue Water Bridge shares for commercial vehicle and passenger traffic, respectively, in 2035 under a base case (no build) scenario. The overall stability of new crossing shares from 2008 to 2009 is also encouraging.

Exhibit 4-4: 2035 Commercial Vehicle Crossing Choice Shares by Direction and Scenario

Model	Scenario	Ambassador Bridge (%)	New Crossing (%)	Detroit-Windsor Tunnel (%)	Blue Water Bridge (%)
2009 To USA	Build	31.9	46.1	1.4	20.6
	No Build	61.9		2.0	36.1
2008 To USA	Build	35.0	45.1	1.4	18.5
	No Build	70.4		2.9	26.7
2009 to Canada	Build	34.2	41.9	2.6	21.3
	No Build	66.4		2	31.6
2008 to Canada	Build	29.1	41.5	2.1	27.3
	No Build	58.1	-	4.1	37.8

Exhibit 4-5: 2035 Passenger car Crossing Choice Shares by Direction and Scenario

Model	Scenario	Ambassador Bridge (%)	New Crossing (%)	Detroit-Windsor Tunnel (%)	Blue Water Bridge (%)
2009 To USA	Build	22.2	28.3	21.8	27.7
	No Build	35.7		32.4	31.9
2008 To USA	Build	24.3	26.1	22.1	27.5
	No Build	37.4		33.3	29.3
2009 to Canada	Build	23.8	26.2	25.8	24.2
	No Build	34.3		38.3	27.4
2008 to Canada	Build	24.1	28.6	23.5	23.7
	No Build	35.6		33.9	30.5

The one area of particular risk in the crossing choice model is the traffic share between the Ambassador Bridge and new DRIC crossing due to their close proximity and the similar markets that they serve. The logit crossing choice model splits traffic between the two crossings based on differences in travel times (which tend to be in the 2-3 minutes range depending on the origins and destinations as described in the previous section), and the bias constant derived from the stated preference surveying exercise. This bias constant is meant to capture all of the non-quantifiable effects that would influence a user's decision to choose a particular crossing. The Ambassador Bridge bias constant is equivalent to 10 minutes of travel time for commercial vehicles, and 5 minutes of travel time for passenger travel.

An effect that may be under-represented in the bias constant and stated preference work is the reliability and overall attractiveness of the new crossing option. With the new crossing being served directly by a grade-separated expressway, trucks and passengers headed to /from Windsor by way of Highway 401 who choose to take the Ambassador Bridge would have to exit the freeway and travel through the series of traffic signals on Huron Church Road all the way to the bridge. While the Ambassador Bridge would be more direct for travel to central Detroit, the minute or two that could be saved is perhaps less important when compared to the ease of accessing the new crossing, particularly when looking at longer trips that are often well over an hour in total travel time. In general, the bias constant is a somewhat crude estimate and

“catch all” for all of the non-quantifiable travel benefits that exist for the new crossing option.

A further characteristic of a logit model approach for crossing choice is the smoothing effect of the logit equation, which may lead to a more conservative estimation of demand for the DRIC crossing. Logit models predict choice probabilities and thus there is an implicit tendency to assign at least small shares to all options that are within the choice set. Depending on the steepness of the logit curve estimated (which is based on the strength of the level-of-service variables relative the constant terms), logit equations will not predict large shares (%80+) for a particular option unless the utility differences or relative attractiveness of an option is extreme, despite perhaps dominating in all measurable factors and having a clear advantage.

As an example, a majority of truck trips travelling from Highway 401 in Windsor are destined south on I-75 and reach a decision point at EC Row and Huron Church Road. An Ambassador Bridge routing requiring the driver to exit Highway 401 and travel on Huron Church Road to reach the Ambassador Bridge and then onto I-75. The alternative DRIC crossing approach continues on a grade-separated highway facility to the new bridge crossing and then connects to I-75 and provides an approximate 2-3 minute travel time saving, 1 mile distance saving, the convenience of avoiding the signalized intersections of Huron Church Road and the simplicity of following one continuous highway route to the international crossing. For this particular Highway 401 to I-75 south movement, the logit model estimates that upwards of 30% of users will use the Ambassador Bridge over the DRIC crossing, which is reflective of the 2-3 minute travel time difference along with the bias constant, but perhaps not full effect of the ease and convenience of using the DRIC crossing.

Nonetheless, the methodology used is still very strong and is considered state of practice for route choice modeling. The end result is a perhaps a slightly conservative but defensible forecast of overall crossing share for the new crossing with a higher probability of under-estimating, rather than over-estimating the actual crossing share.

4.5 Traffic Forecasts

The traffic forecasts for the DRIC Refresh reflect the effects of the current economic downturn and effectively represent a delay of five years to reach equivalent total transaction levels from the 2008 forecasts. As part of the peer review process, the annual transaction projections for the 2008 Windsor Gateway Study are compared to the 2009 Refresh results to understand the impacts of changing inputs on forecasted traffic levels. Exhibits 4-6 and 4-7 compare the revenue streams in 5 year increments for the 2008 and 2009 forecasts. The largest changes are seen in passenger car annual transactions which fall 20-30% below the 2008 forecasts in the near to mid-term. This is expected based on the latest economic information and is consistent with the corridor growth assumptions that predict larger reductions in same-day and overnight passenger car traffic due to increased border security restrictions. This 20-30% reduction is equivalent to 7-8 years of traffic growth. Much less volatility is seen in the commercial vehicle forecasts outside of the very near term, and on average there is a 4% reduction in the 2009 Refresh forecasts compared to the 2008 results. This reduction is roughly equivalent to one year's traffic growth.

Exhibit 4-6: Passenger Car Annual Transactions Comparison (in Thousands)

Year	2008 Windsor Gateway	2009 Refresh	2009/2008
2016	4,328	3,073	0.71
2020	4,969	3,524	0.71
2025	5,827	4,418	0.76
2030	6,474	5,384	0.83
2035	6,918	6,000	0.87
2040	7,243	6,351	0.88
2045	7,621	6,656	0.87
2050	8,093	6,995	0.86
2055	8,535	7,335	0.86
2060	8,952	7,678	0.86

Exhibit 4-7: Commercial Vehicle Annual Transactions Comparison (in Thousands)

Year	2008 Windsor Gateway	2009 Refresh	2009/2008
2016	2,981	2,747	0.92
2020	3,518	3,423	0.97
2025	4,063	3,921	0.97
2030	4,587	4,411	0.96
2035	5,063	4,870	0.96
2040	5,516	5,312	0.96
2045	5,954	5,739	0.96
2050	6,387	6,153	0.96
2055	6,811	6,558	0.96
2060	7,258	6,985	0.96

Overall, the DRIC Refresh traffic forecasts appear reasonable and defensible and consistent with current economic projections in light of the recent economic downturn.

4.6 Sensitivity Analysis

WSA performed a detailed series of sensitivity tests assessing the impacts on crossing splits for each of the key explanatory variables: toll rate at each crossing and variations in border crossing time at each location. Sensitivities were tested for commercial vehicles and passenger car, as well as the resulting impacts on total transactions and revenue. The series of sensitivity tests were rigorous and were successful in showing the impacts of changes in key variables on transactions and revenues.

The final element of the risk analysis presented the results of a low case and high case which are made up of a series of toll rate and border crossing time assumptions as presented in Table 7-5 in the WSA report. While the risk assessment is helpful, it would be aided by some additional context behind the assumptions. Additional clarification would be helpful in better understanding what the high and low scenarios represent, for example is the low scenario equivalent to the impacts of another recession similar in scale to the current one,

or does it correspond to several large recessions over the time horizon. Any framing of the economic scenarios would make it easier to understand the probability of the low case occurring and to put the analysis in context.

5. Summary

The objective of the internal peer review was to assess the credibility, reasonableness and any associated risks with the forecasts and their reliability with respect to supporting informed decision-making by MDOT. As an internal peer review, IBI Group was part of the WSA Team responsible for the development of traffic and revenue forecasts and thus was involved in discussions with WSA throughout the study. As a part of working on the internal team, IBI and WSA were able to identify any issues as they were discovered and address any problems in the development of the Refresh Forecasts. A summary of the principal findings of the DRIC Forecast Refresh peer review include:

- The approach was sound and comprehensive, capturing the main factors affecting cross-border traffic levels using state of practice methods. Although no mathematical model can capture all of the factors involved as the cross border traffic levels can be influenced by extreme events, and be difficult to isolate, the peer review process has concluded that the WSA team has successfully identified the main underlying causal variables;
- The crossing choice model functions well both in design/conduct and in application. The crossing choice model is a state-of-practice tool and is able to analyze very complex situations while capturing the important markets and main trade-offs;
- Conservative assumptions are used, including economic growth at a lower range compared to other well-known forecasts. Travel time savings and benefits with the new crossing may also be slightly conservative.
- The value of reliability is an important consideration in route choice and is not explicitly captured with the stated preference work and crossing choice models. The effects of reliability will be a positive impact on the use of the new crossing.
- Economic growth assumptions appear reasonable, lower than historic growth rates and marginally lower than the DRIC forecasts in terms of total vehicle cross-border demand. Cross-border traffic, particularly commercial vehicle traffic, is highly tied to the US economy and Canada-US trade and will such grow strongly given the expected strength of the US economy over the long term.